



1



Hace muchísimos años

Érase una vez un gran castillo. Con valientes caballeros, caballos, reyes, reinas y torneos. Y muchas aventuras todos los días.

Así comenzaba la descripción del ahora emblemático set Castle (375) en el catálogo de productos LEGO® cuando

se lanzó al mercado en 1978. Frecuentemente referido hoy día como *el castillo amarillo* o *el castillo original*, marcó el comienzo de una entrañable aventura medieval que continuaría sin interrupción hasta 1999. Como parte

de las celebraciones por el 90 aniversario de LEGO, elegimos rendir un homenaje a este popular tema con el nuevo modelo Castillo de los Caballeros del León, inspirado en el clásico set King's Castle (6080) de 1984.

1978



375 Castle

¡El castillo original con el que todo comenzó! Los llamativos muros amarillos de este castillo estaban articulados con el fin de crear múltiples configuraciones y acceder al interior para jugar con facilidad. Si bien el tono amarillo pronto cayó en desuso en favor de un gris más realista, el diseño con muros articulados aún puede verse en los castillos LEGO de nuestros días.

Algunas de las peculiaridades de este modelo son los caballos para construir con ladrillos y el clásico casco espacial modificado con una visera para los caballeros.

1984



6080 King's Castle

1986



6074 Black Falcon's Fortress

1987



6066 Camouflaged Outpost

¡El escondite secreto original de los pobladores del bosque! Un antiguo roble envuelve con sus raíces una enorme roca, ¡pero hay mucho más de lo que se ve a primera vista! Una puerta giratoria oculta hecha de roca da acceso a la cueva de los habitantes del bosque y una parte posterior articulada revela el espacio interior para jugar. Este set contenía un total de 6 habitantes del bosque, incluido su enigmático líder.

1992



6086 Black Knight's Castle

¡La máxima expresión de los castillos clásicos! Esta impresionante fortaleza está construida sobre una base elevada, lo que permite que existan unas mazmorras bajo el patio. El castillo siguió la tradición de contar con un puente levadizo y un rastrillo que funcionaban de verdad, además de incluir una puerta posterior secreta para escapadas rápidas o aventuras a medianoche. El imponente Black Knight's Castle fue el hogar de 4 caballeros armados y montados a caballo, 6 soldados, un bandolero Wolfpack, ¡e incluso un fantasma!

1992



6038
Wolfpack Renegades

1997



6097
Night Lord's
Castle

2000



6091
King Leo's
Castle

2004



8781
Castillo de Morcia

2009



10193 Medieval Market Village

Medieval Market Village es uno de los pocos sets que nos muestran la vida más allá de los muros del castillo. Cuenta con dos edificios rústicos de entramado hermosamente detallados, una rueda hidráulica para impulsar el martillo de forja, soldados, establos, un carro tirado por caballos, ie incluso un par de vacas!

2016



70317
Fortrex

Un nuevo castillo clásico

Siempre es un desafío reinventar un tema LEGO® tan admirado, pero el nuevo Castillo de los Caballeros del León mezcla lo más complejo de la construcción con LEGO y el espíritu de sets originales como King's Castle (6080) para crear un modelo repleto de características y funciones divertidas.

Comenzamos colocando la torre principal en la parte superior de una formación rocosa LEGO, de manera que el modelo pareciera más alto. Esto también hizo posible incluir habitaciones ocultas y oscuras mazmorras bajo el castillo. Los muros son móviles, y el modelo se puede separar para ofrecer un mejor acceso al castillo y revelar un sinfín de trampillas, pasadizos secretos y escondites ocultos.

2022



Esta nueva versión de un castillo clásico aprovecha las técnicas modernas de construcción e incluye montones de características que rinden homenaje a los sets Castle originales de años atrás.

Para celebrar 90 años de creatividad con LEGO en 2022, pedimos a los fans que votaran por los temas LEGO clásicos que más deseaban revivir en un set especial de aniversario. Decenas de miles de fans participaron en la encuesta, ¡y el tema Classic Castle fue uno de los indiscutibles ganadores!

90 years of play

LEGO YELLOW CASTLE, 1978

Impresiones del equipo de diseño

Los diseñadores de LEGO® Mike Psiaki y Milan Madge siempre soñaron con trabajar juntos en un modelo de castillo LEGO de gran tamaño, ya que el castillo original fue uno de sus temas favoritos cuando eran niños. Mike describe cómo evolucionó el modelo:

Este modelo resultó de una votación realizada como parte de las celebraciones del 90 aniversario de LEGO en 2022. Nos propusimos intentar fusionar tantos sets de castillos del pasado como fuera posible en un nuevo modelo que representara el castillo supremo. Pasamos por muchas rondas de exploración para determinar la forma y el tamaño generales del castillo. Comenzamos construyendo pequeñas secciones de muros, puertas con entramado y puentes levadizos, jugando con diferentes funciones y estéticas para averiguar qué cosas funcionaban bien. En las primeras etapas, Milan descubrió un tipo de puente levadizo que utilizaba un contrapeso en la parte posterior en vez de las tradicionales cadenas conectadas a su parte frontal. Supimos de inmediato que queríamos ponerlo en algún lugar del castillo, pero no fue sino en las últimas etapas de desarrollo cuando se convirtió en la puerta principal.

Después, Ashwin Visser, diseñador gráfico de LEGO, desempeñaría una función crucial en muchos de esos pequeños pero importantes detalles que remataron el set. Entre ellos, la renovación de la imagen gráfica de los Caballeros del León, la creación de nuevos estandartes y escudos de armas para los muros y las almenas del castillo, y la incorporación de la gualdrapa (la vestimenta) en azul y rojo para los dos caballos. El toque final fue la capa totalmente nueva y el escudo de la dama del castillo.

1984



Encuentra las diferencias

Se decidió que los Caballeros del León LEGO clásicos necesitaban renovarse un poco para estar en línea con las ediciones más recientes de los Caballeros del Halcón Negro que aparecían en el set Herrería Medieval (21325). Diseñar el nuevo escudo de los Caballeros del León representó un gran desafío, ya que el objetivo era transformar el emblemático logotipo tan amado por los fans en algo nuevo sin que dejara de ser reconocible.

2022



Ashwin Visser, diseñador gráfico de LEGO



De izquierda a derecha
Michael Psiaki, *maestro de diseño de LEGO®*
Milan Madge, *diseñador de LEGO®*
Ashwin Visser, *diseñador gráfico de LEGO®*

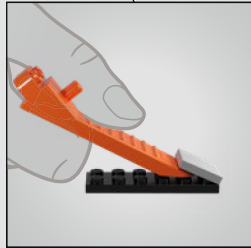
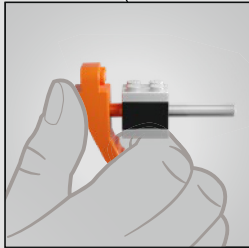
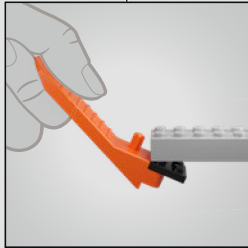
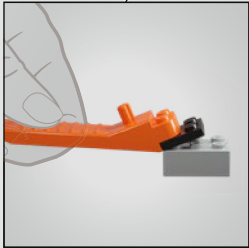
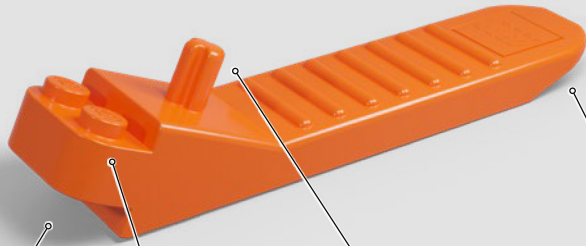

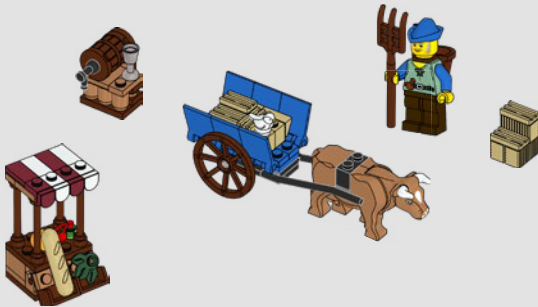
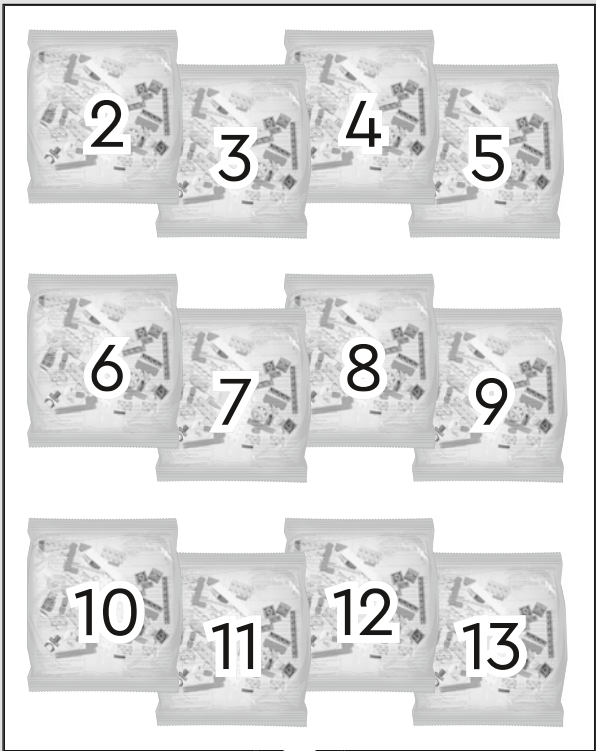

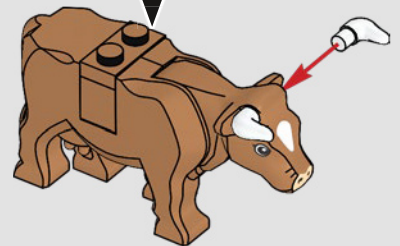
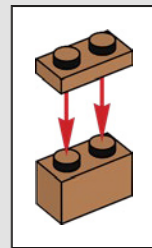
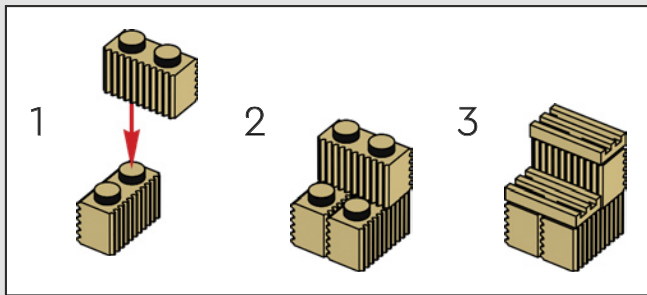
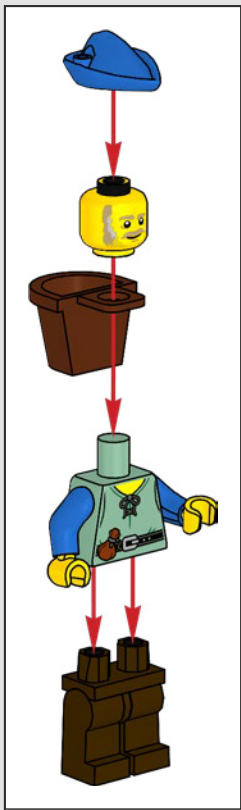

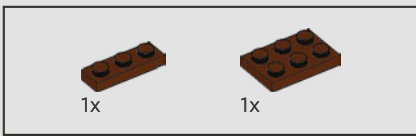

1

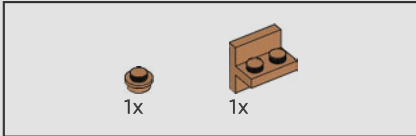
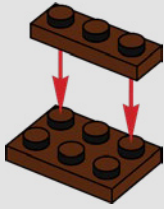

2

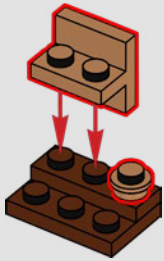

3

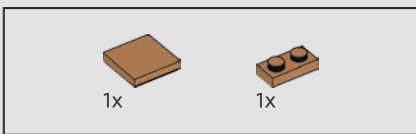
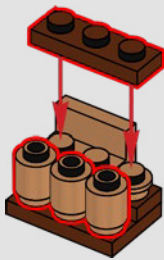

4

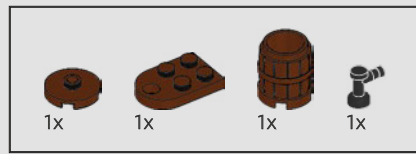
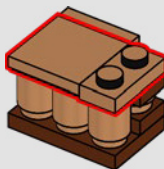

5

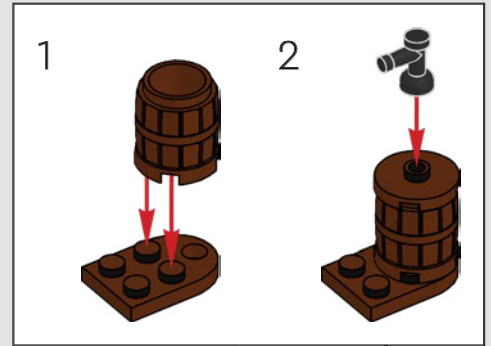

6



¡Ese barril contiene una bebida tan fuerte que podría tornar blanca vuestra barba!

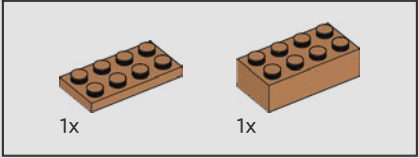

1

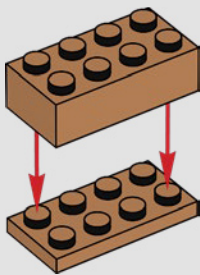

2

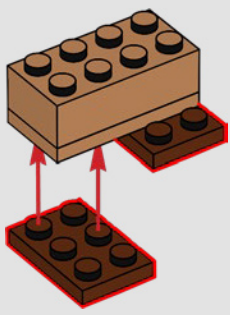

3

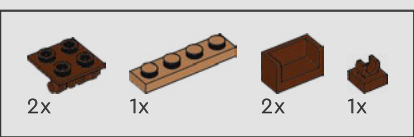
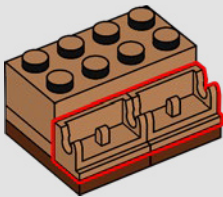

4

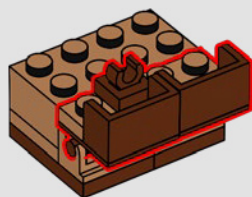
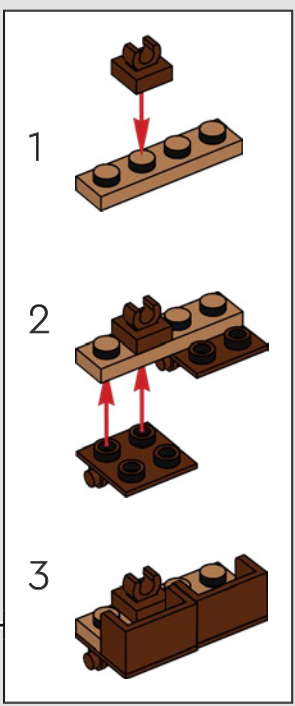

5

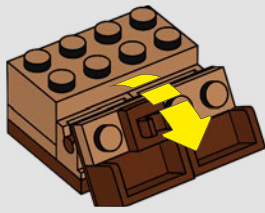

6

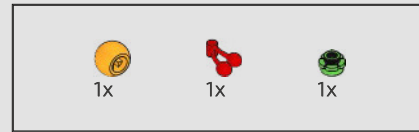
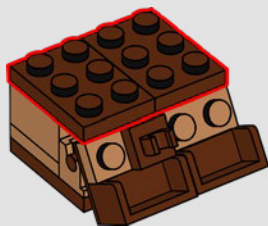

7



8

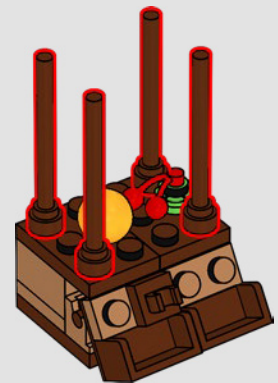

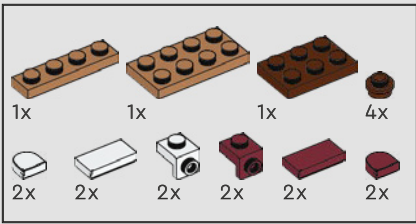

9

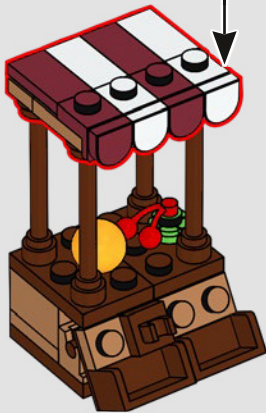
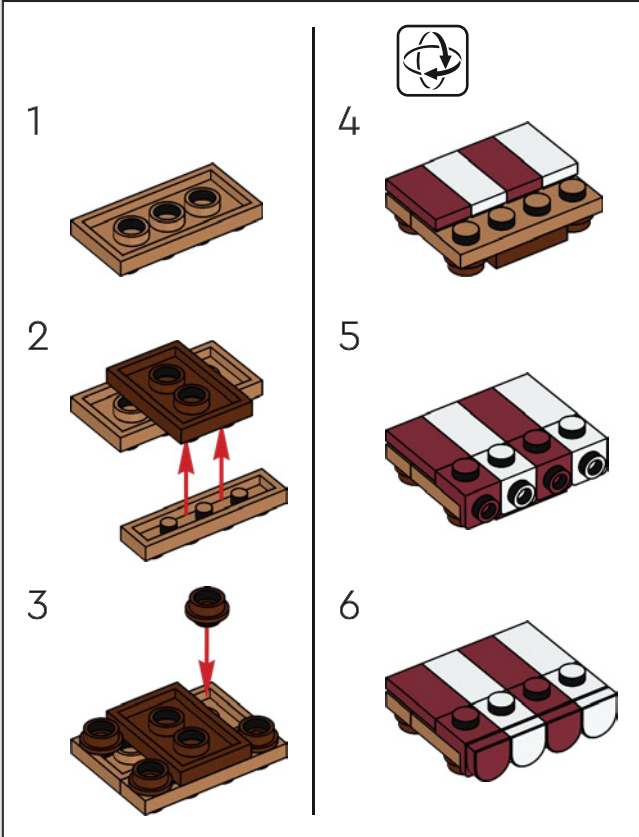

10

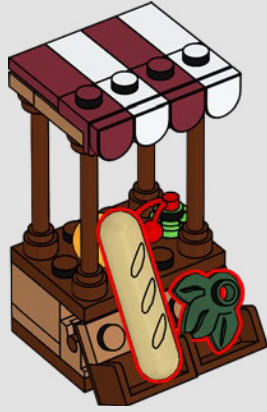

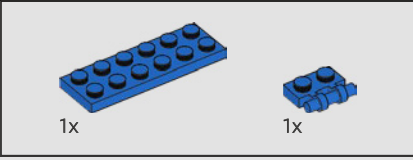
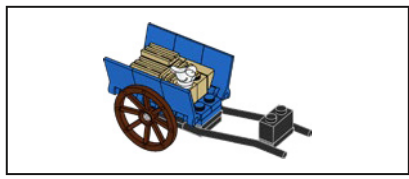

1

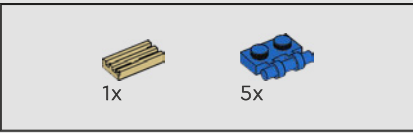
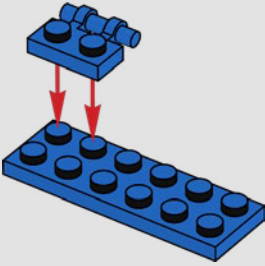

2

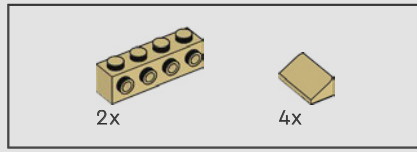
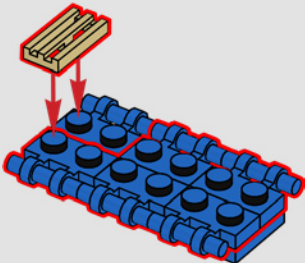

3

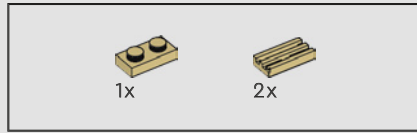
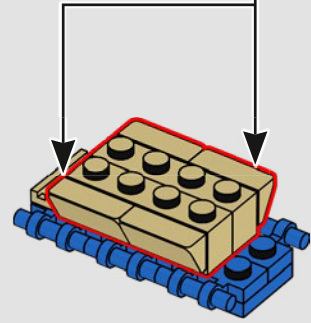
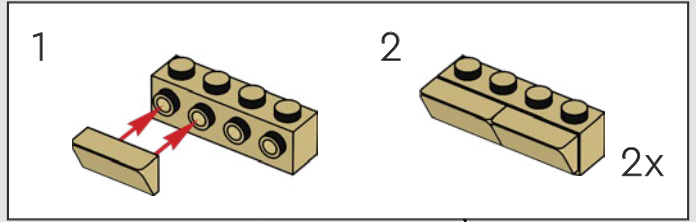

4

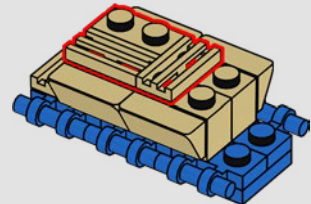

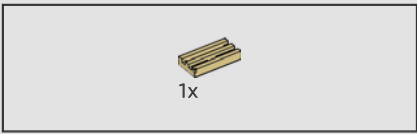

5

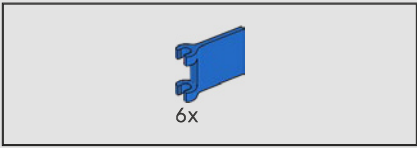
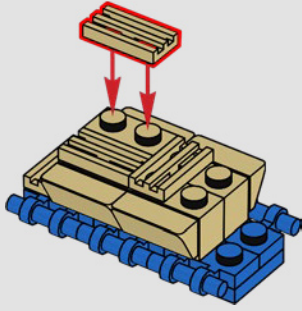

6

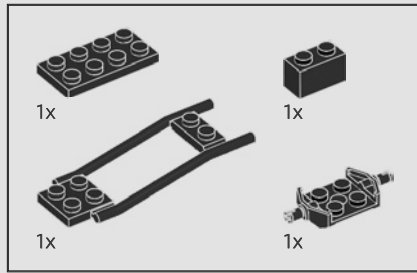
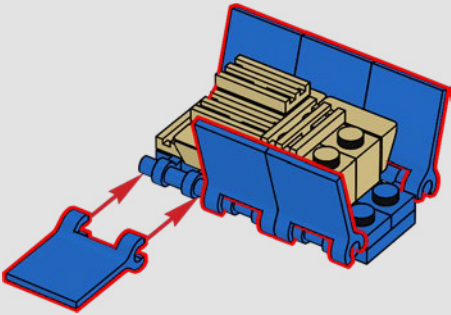

7

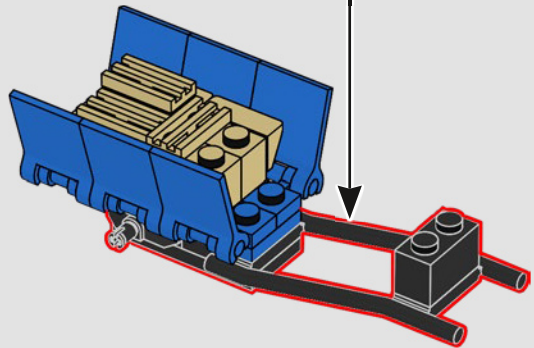
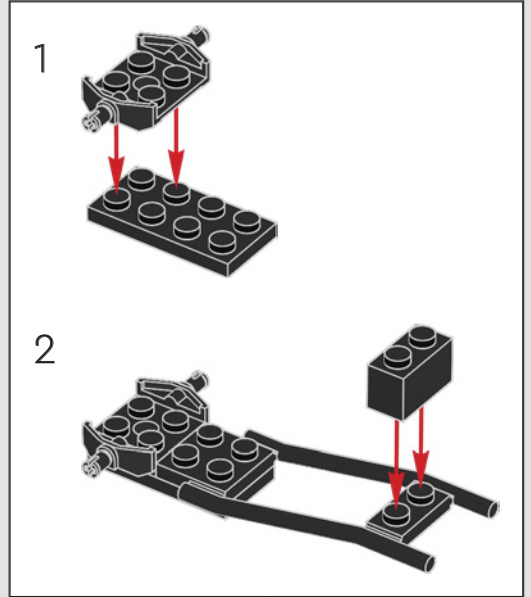



¿Queréis decir que esa carreta va tirada por bueyes? Tamaña rareza se asemeja al velero de mi prima Willa.

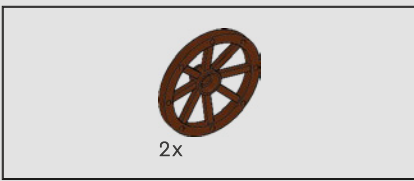

8

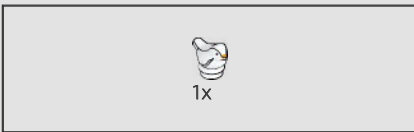
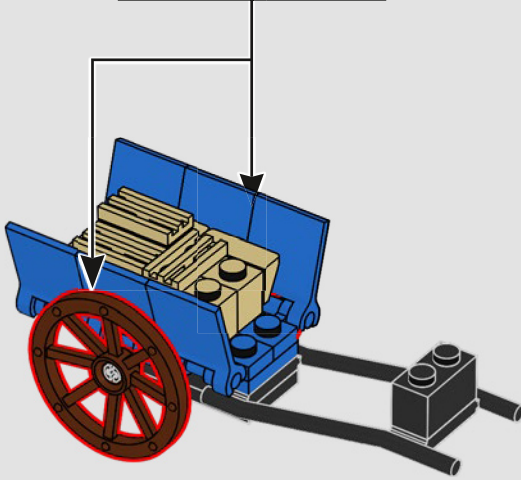
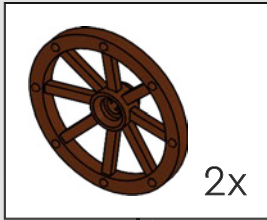

9

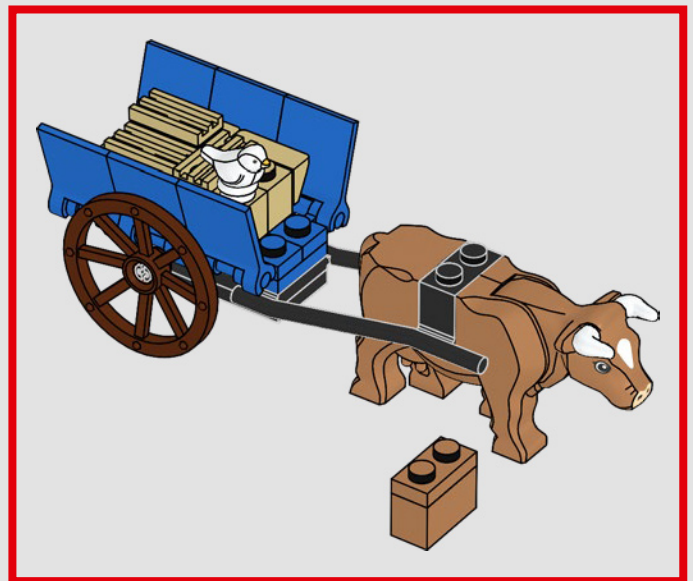
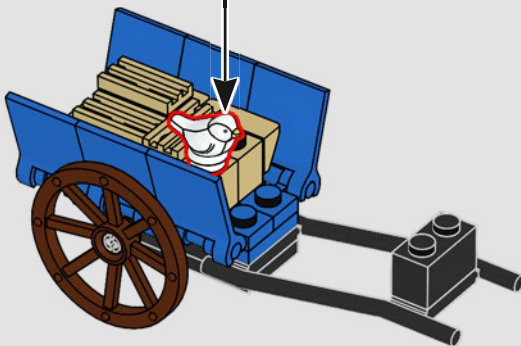
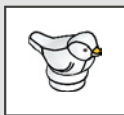

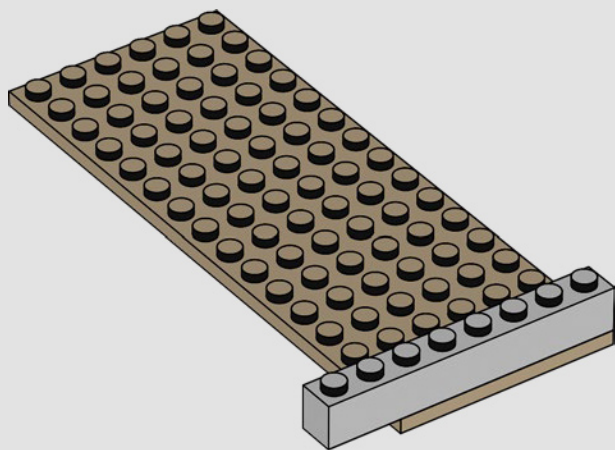
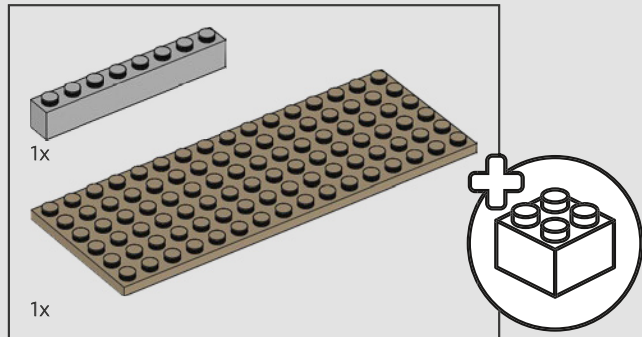
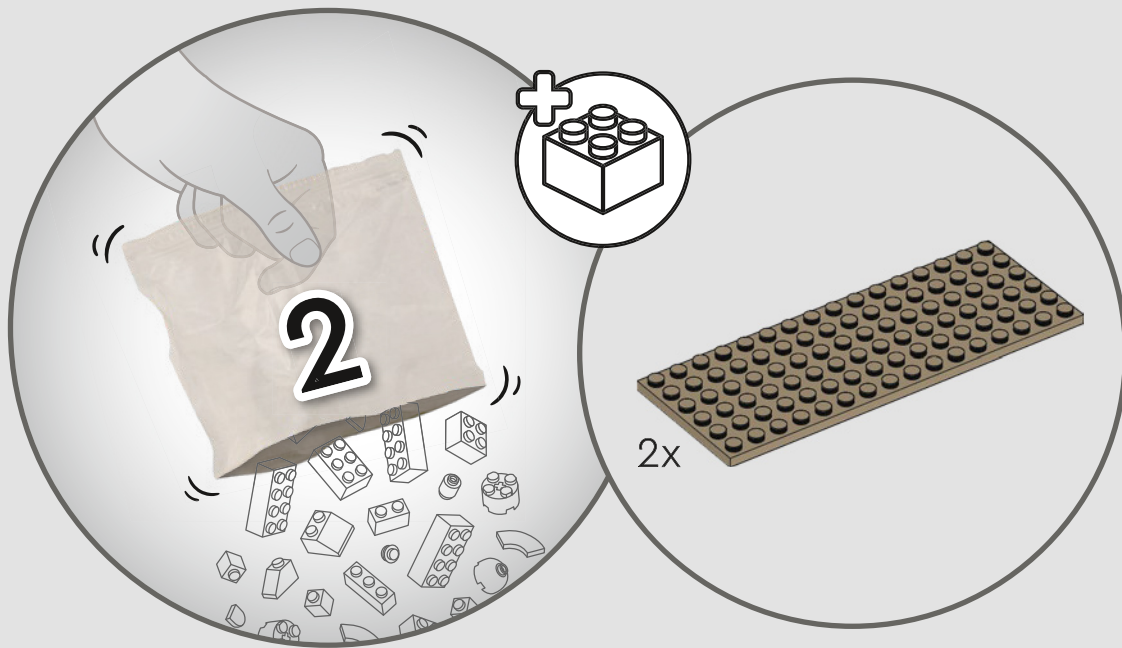

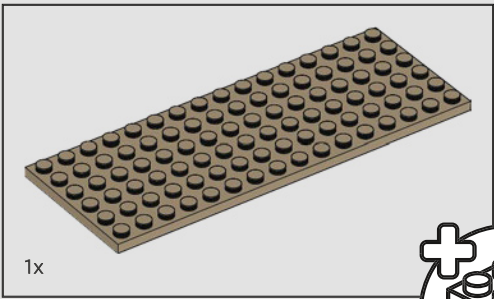

1x

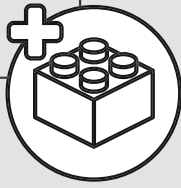

2

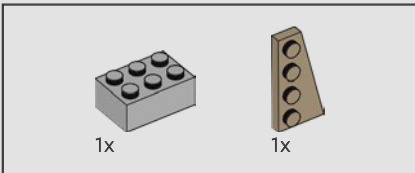
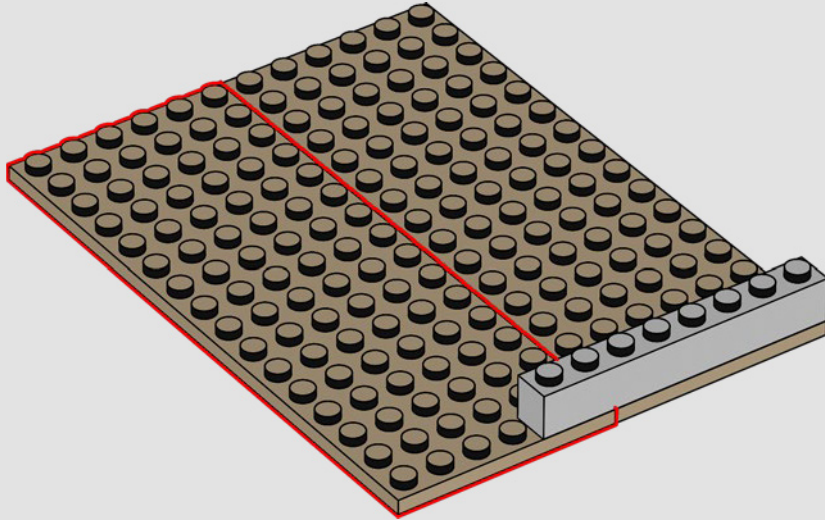

1x

1x

3

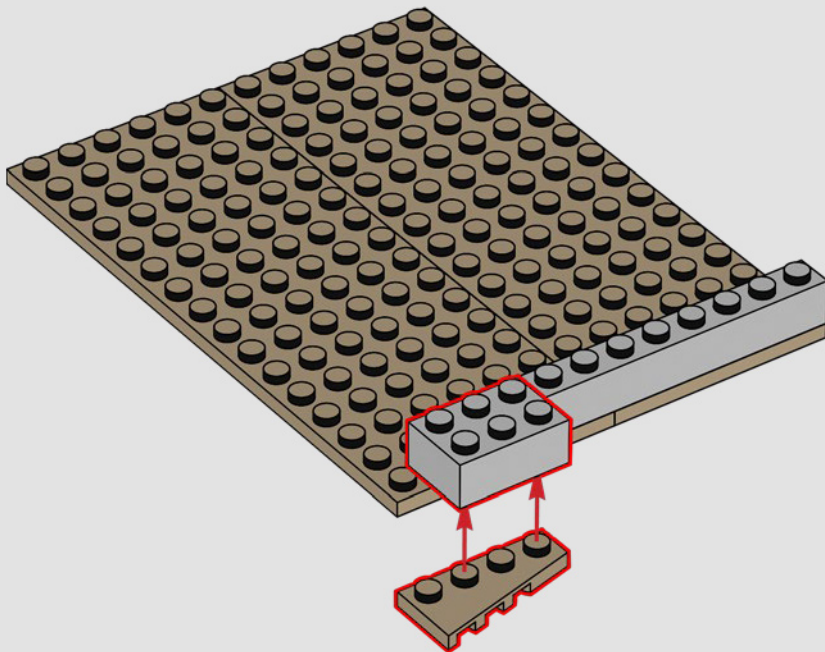

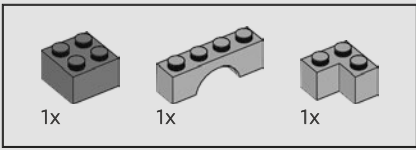

4

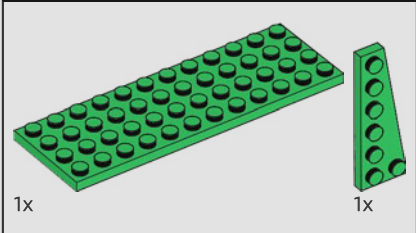
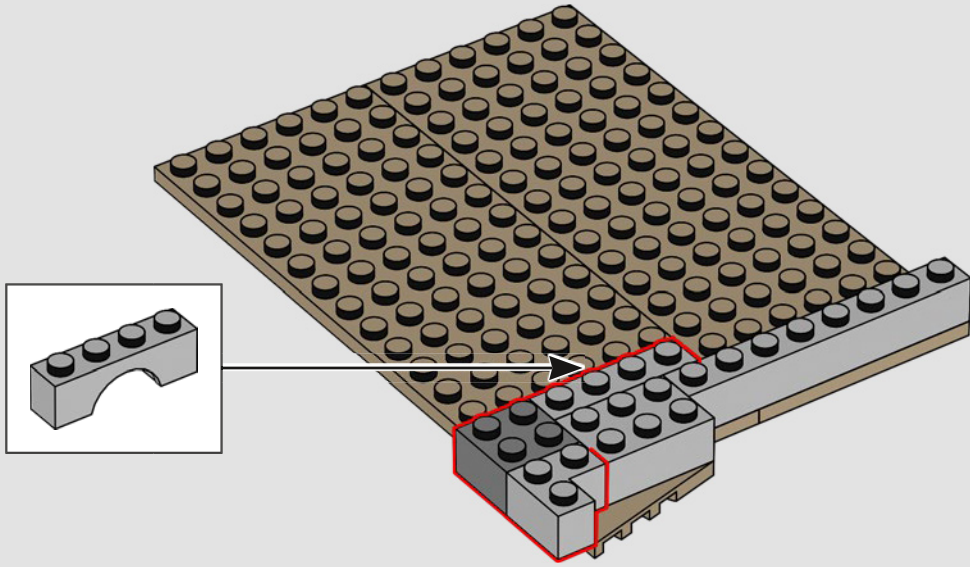

5

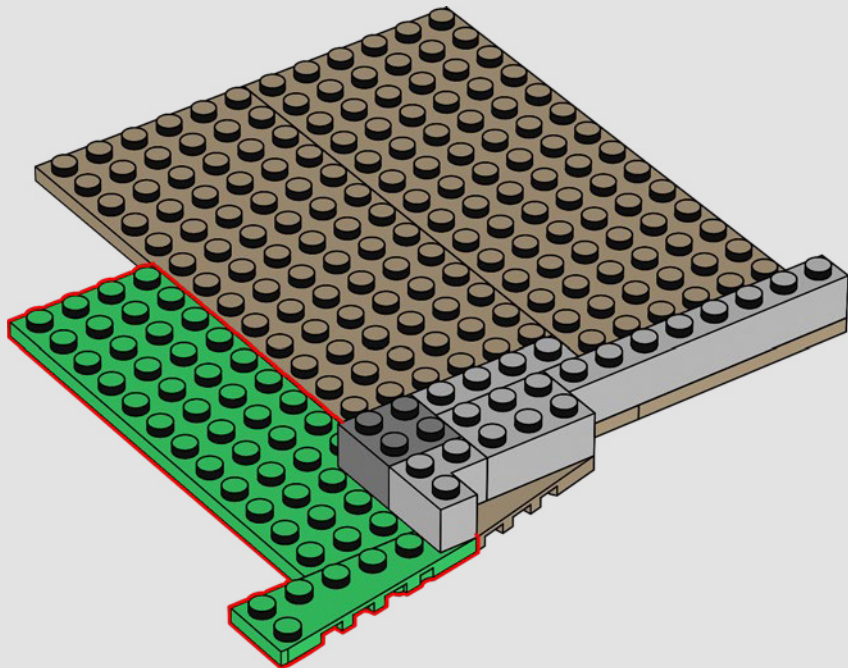

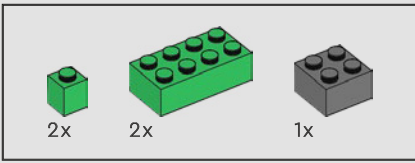

6

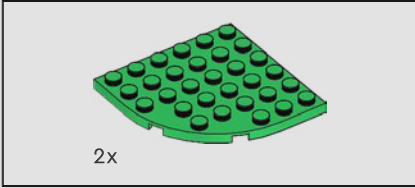
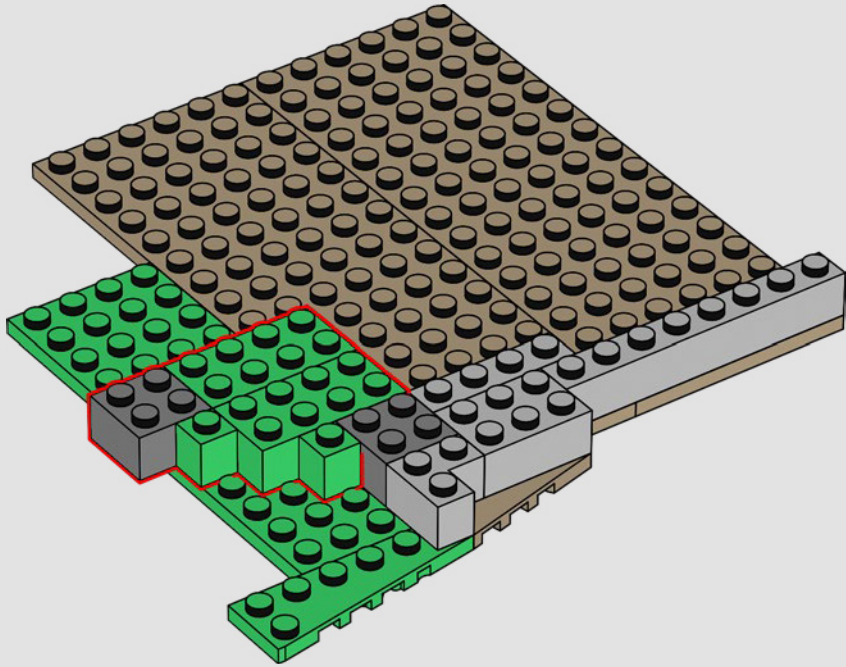

7

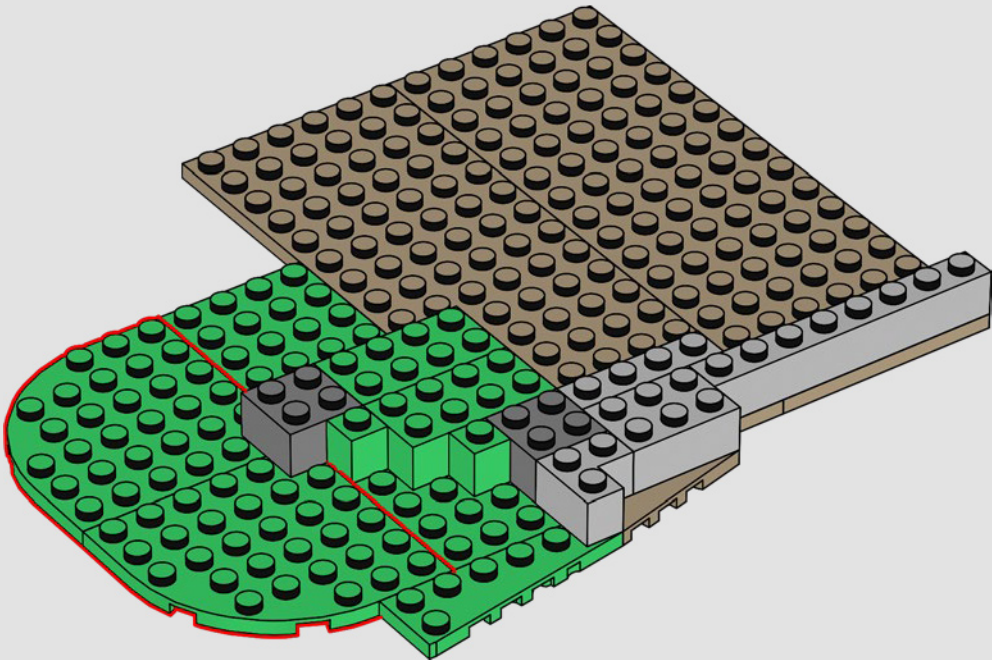

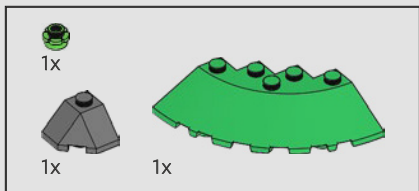

8

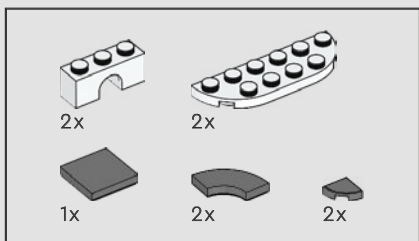
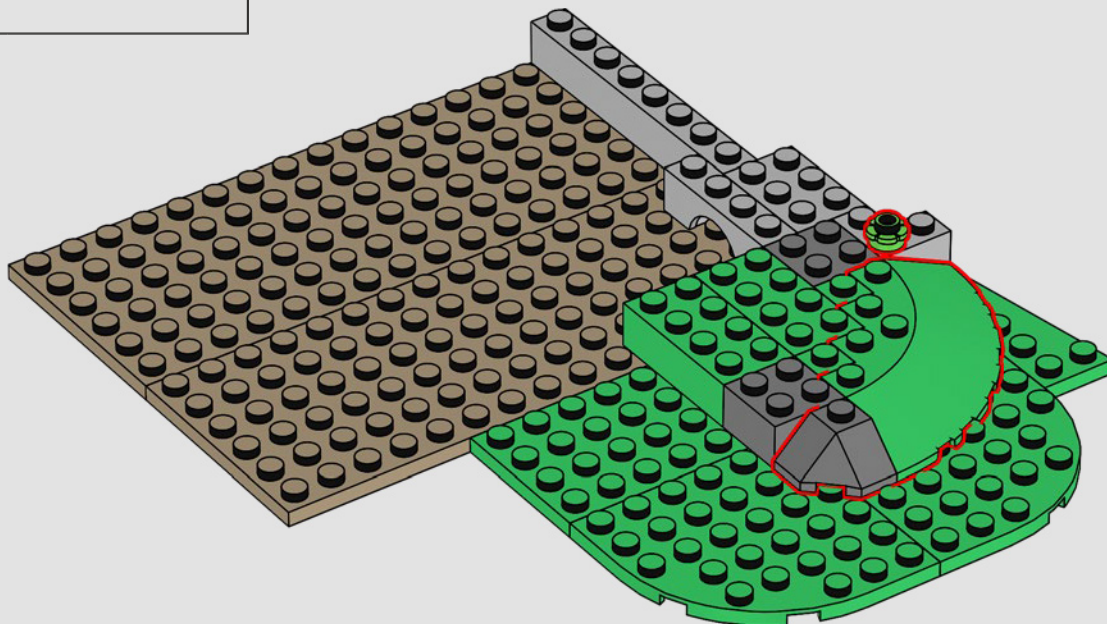

9

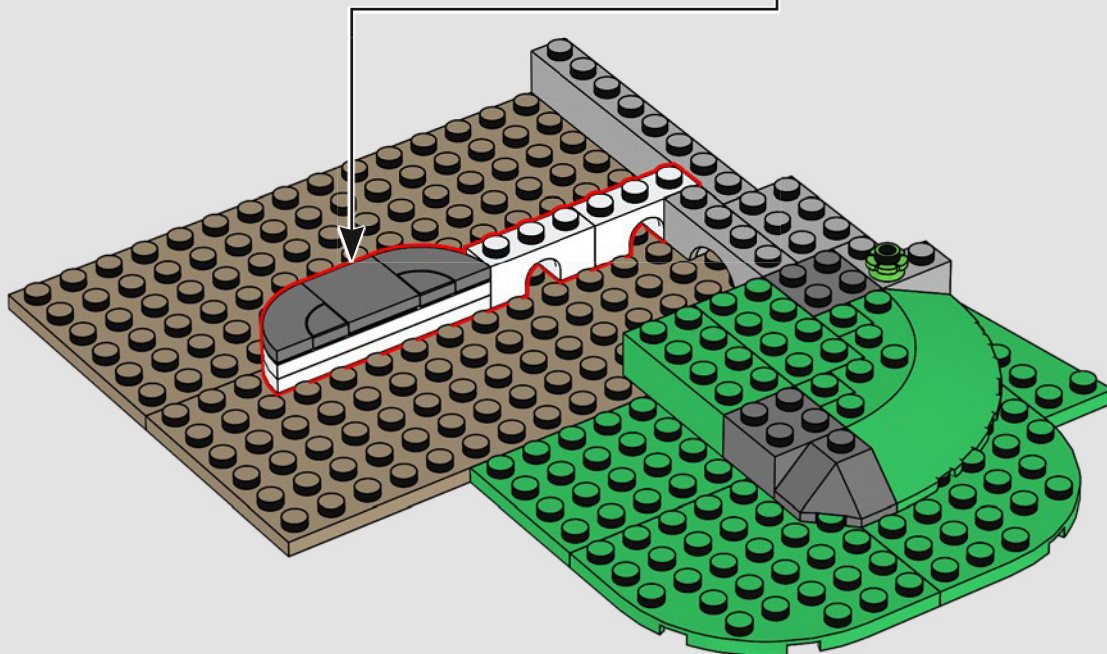
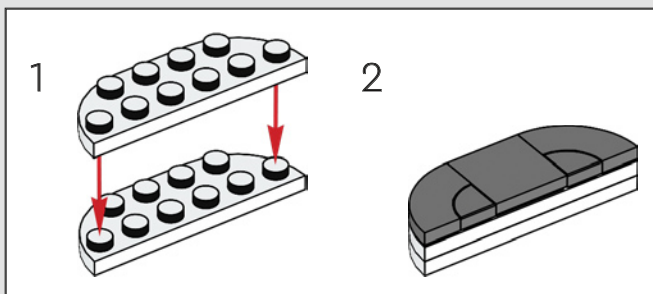

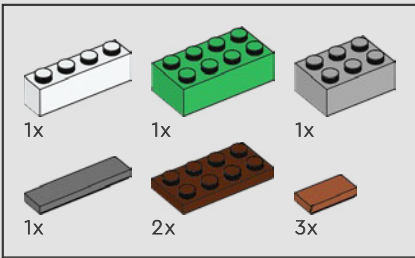

10

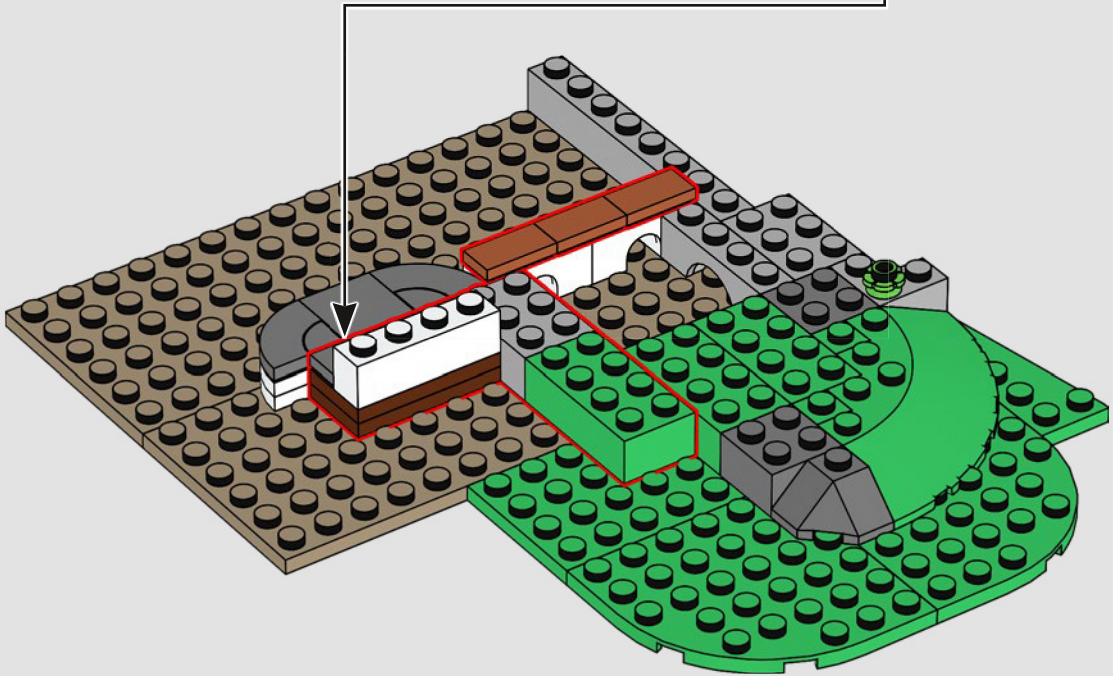
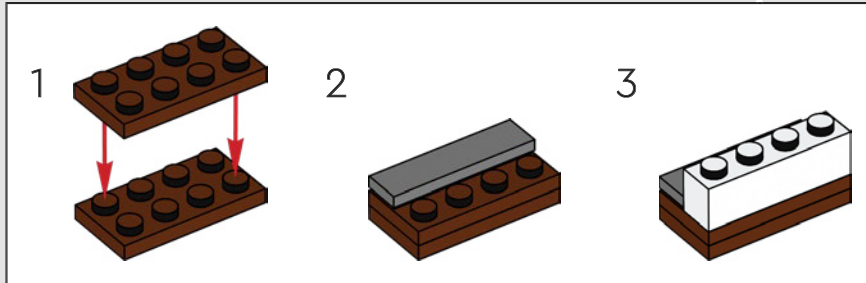

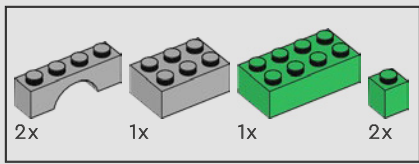

11

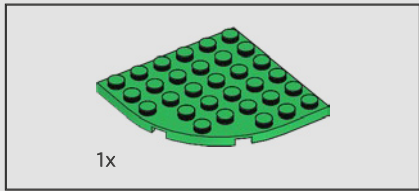
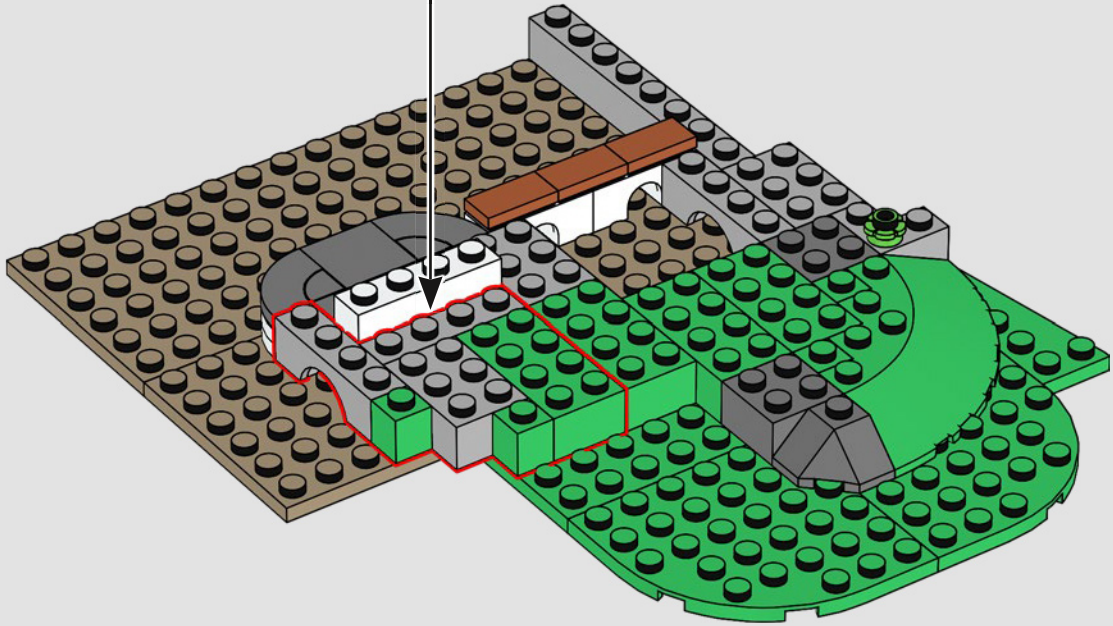
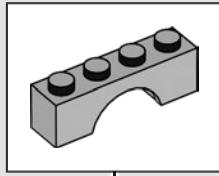

12

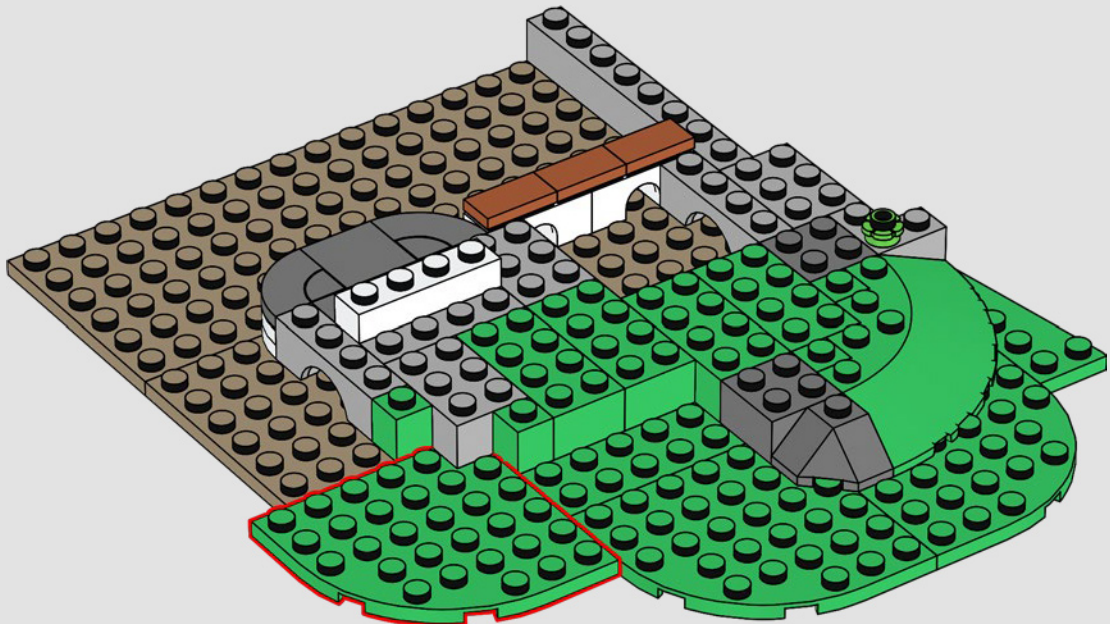

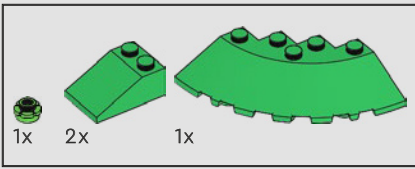

13

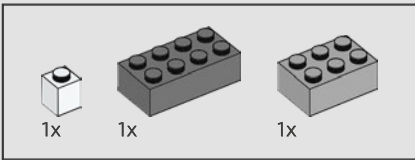
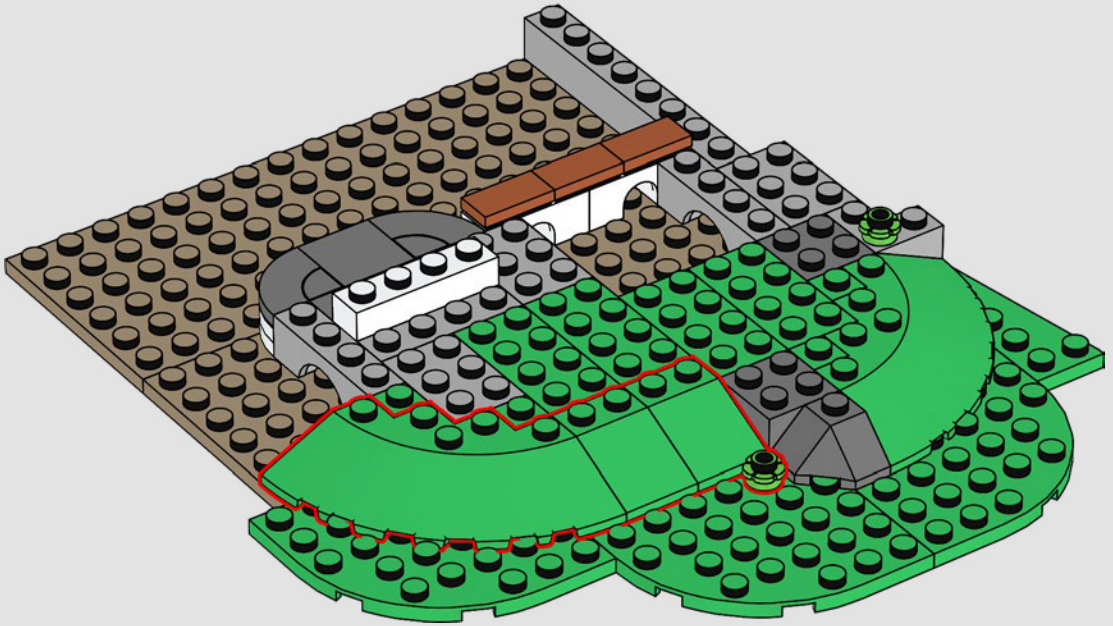

14

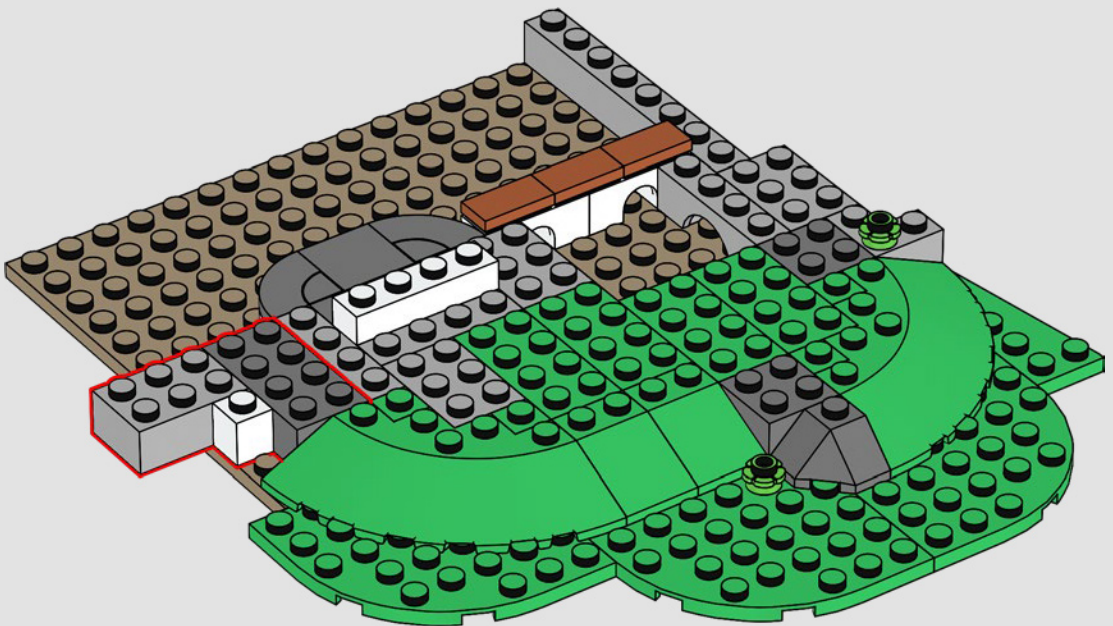

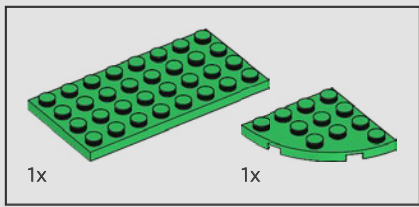

15

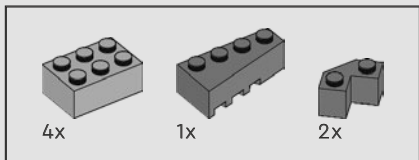
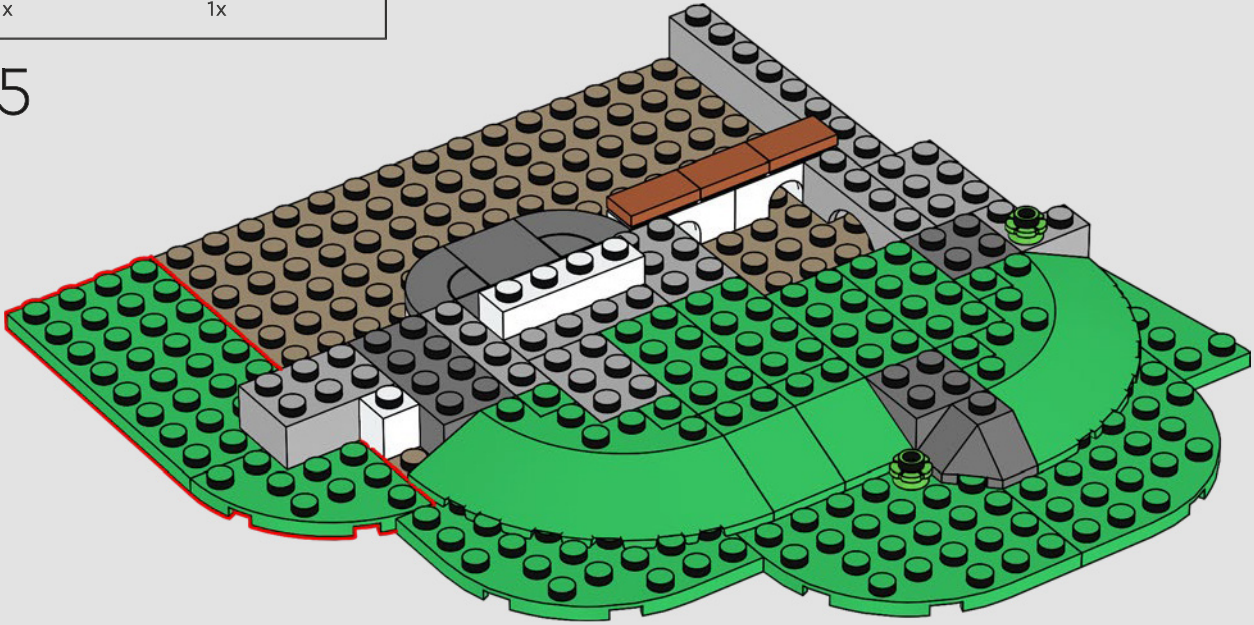

16

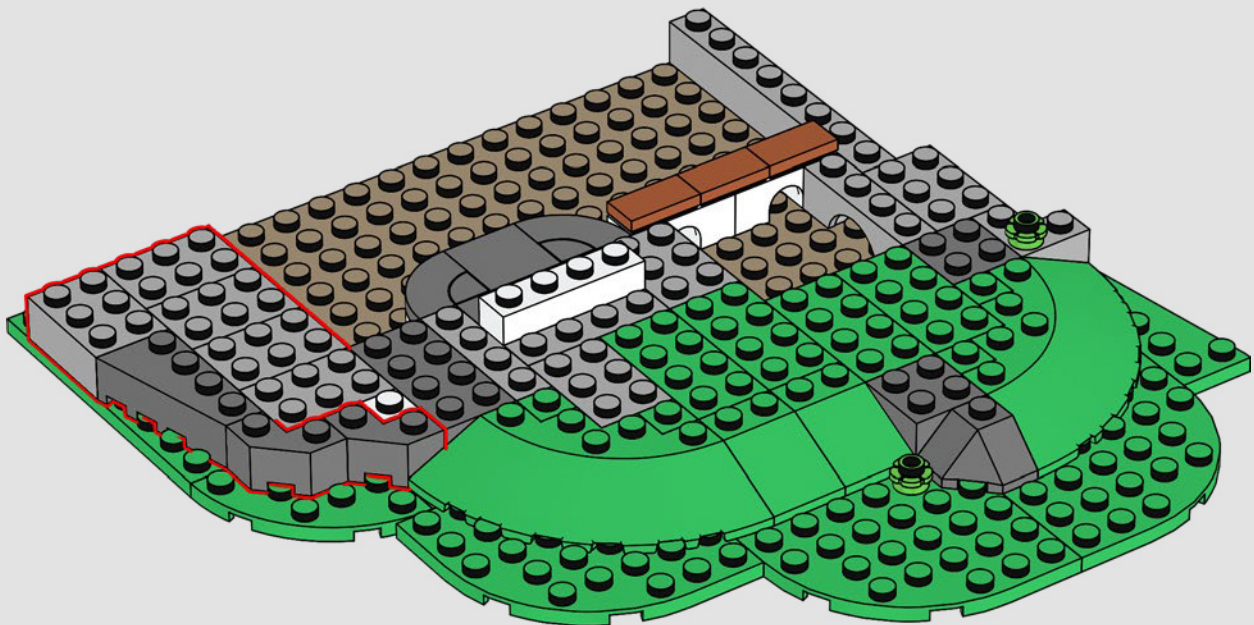

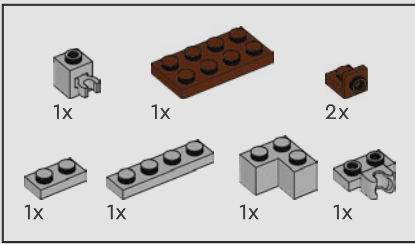

17

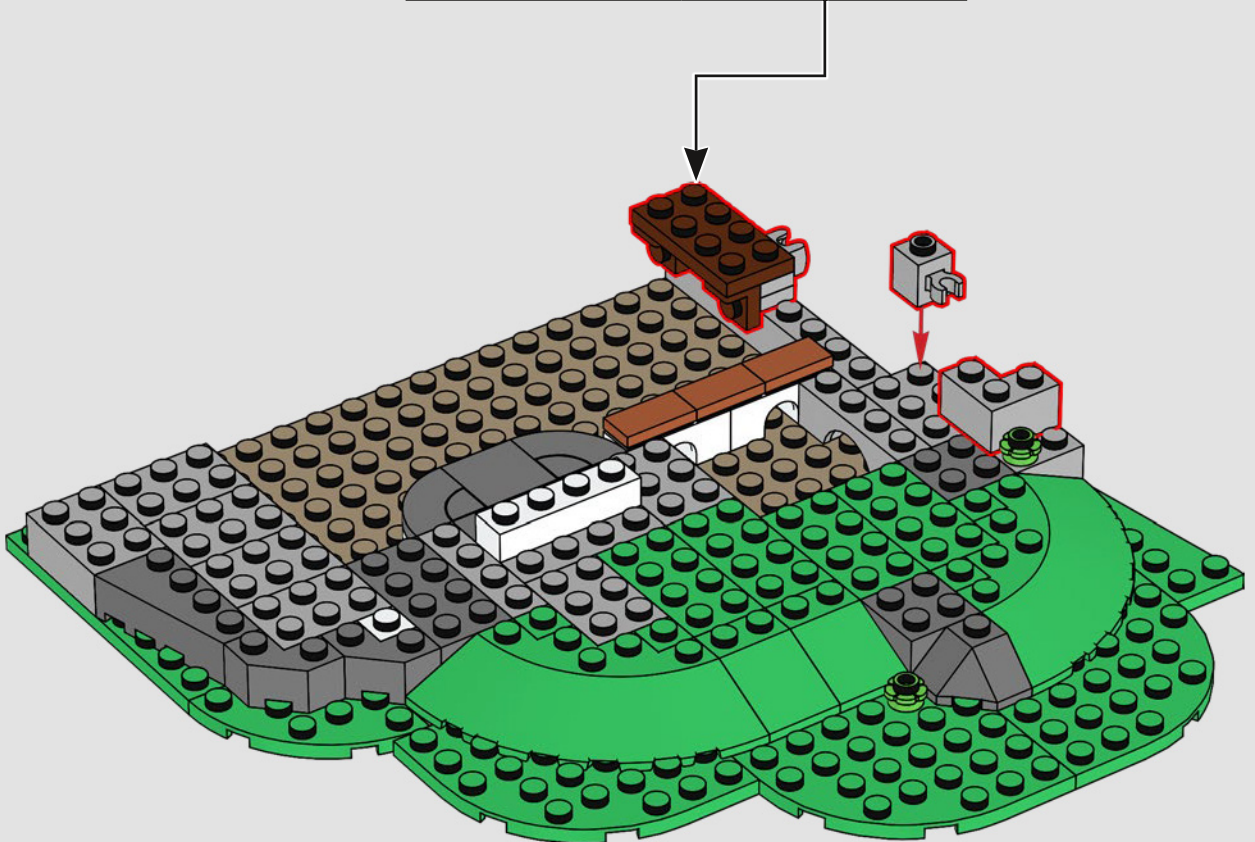
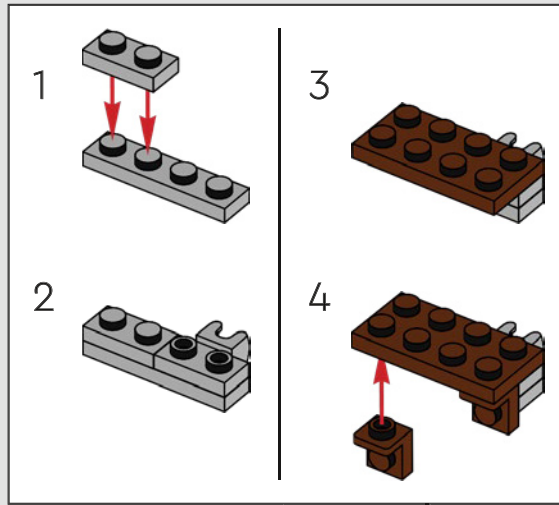

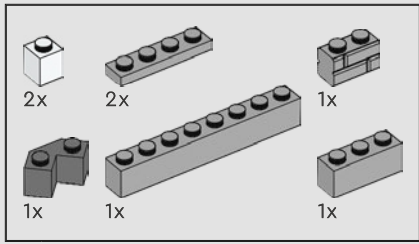

18

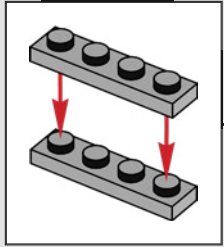
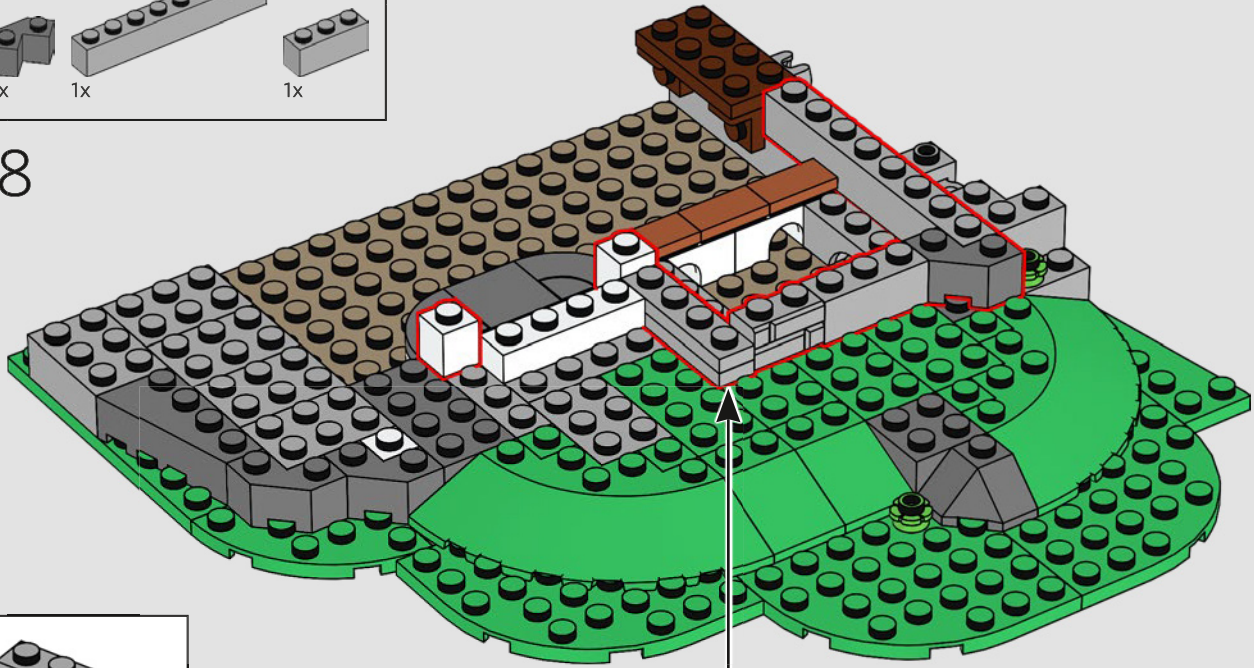

19

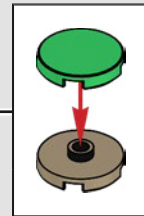
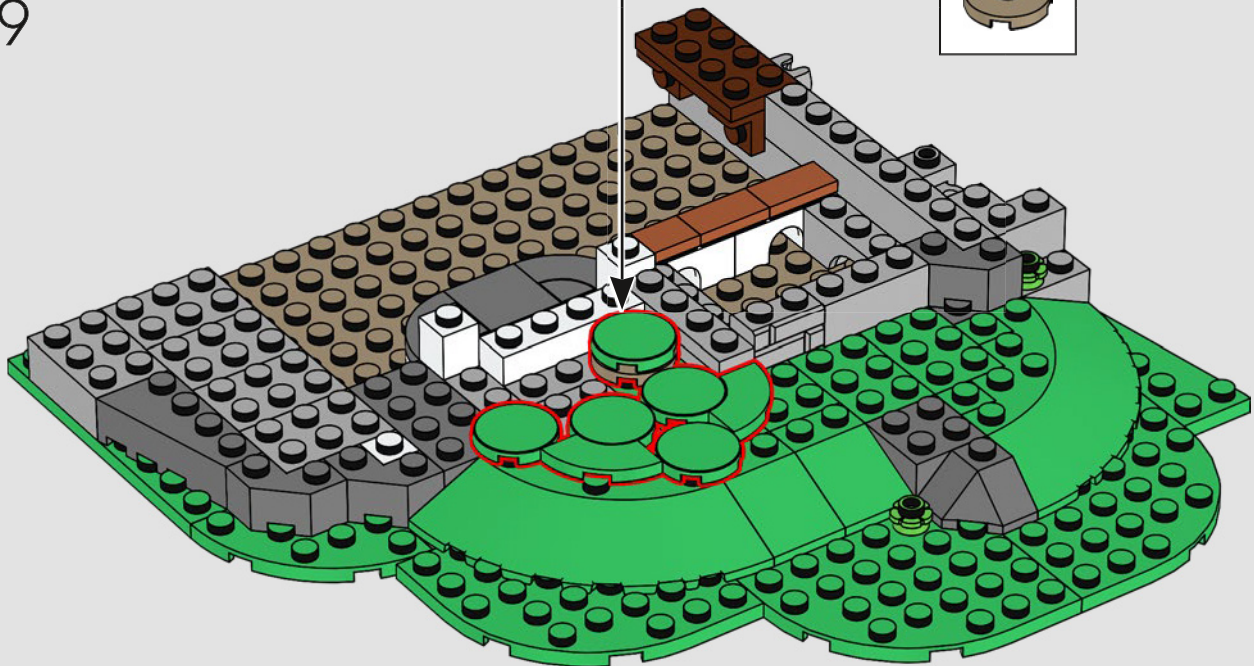

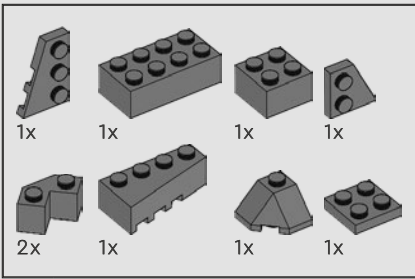

20

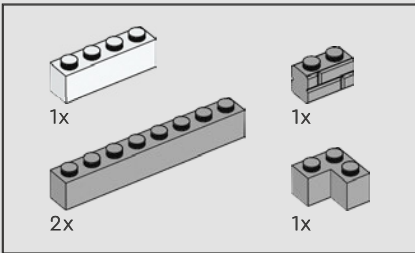
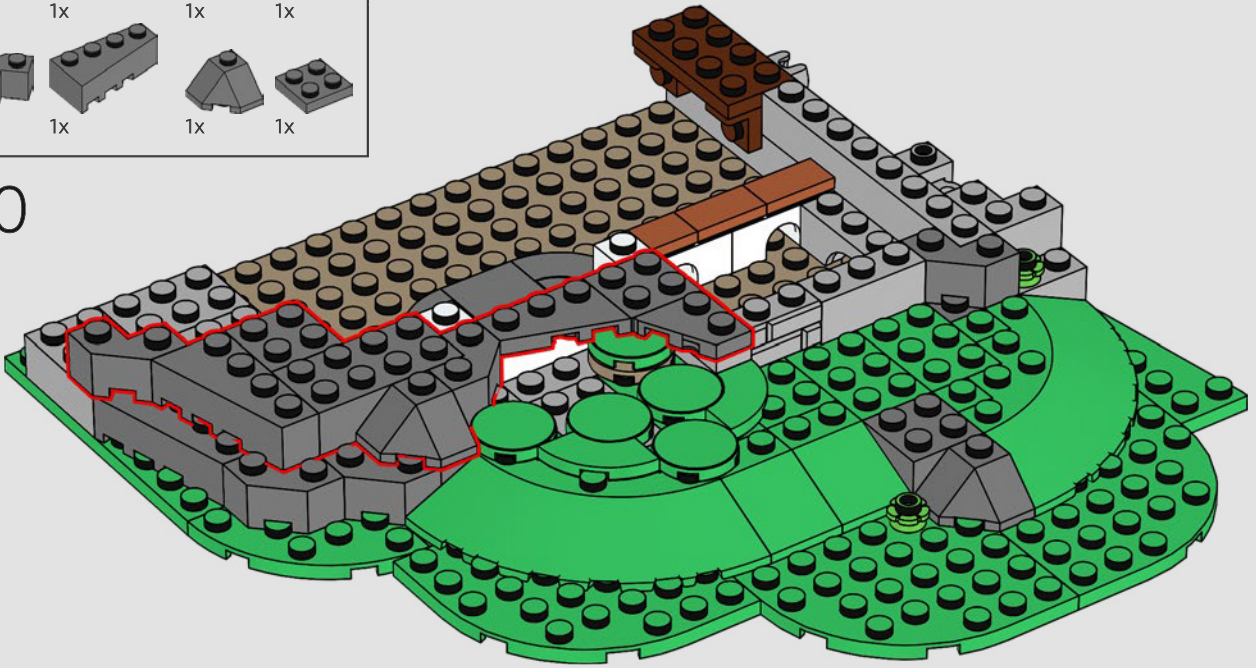

21

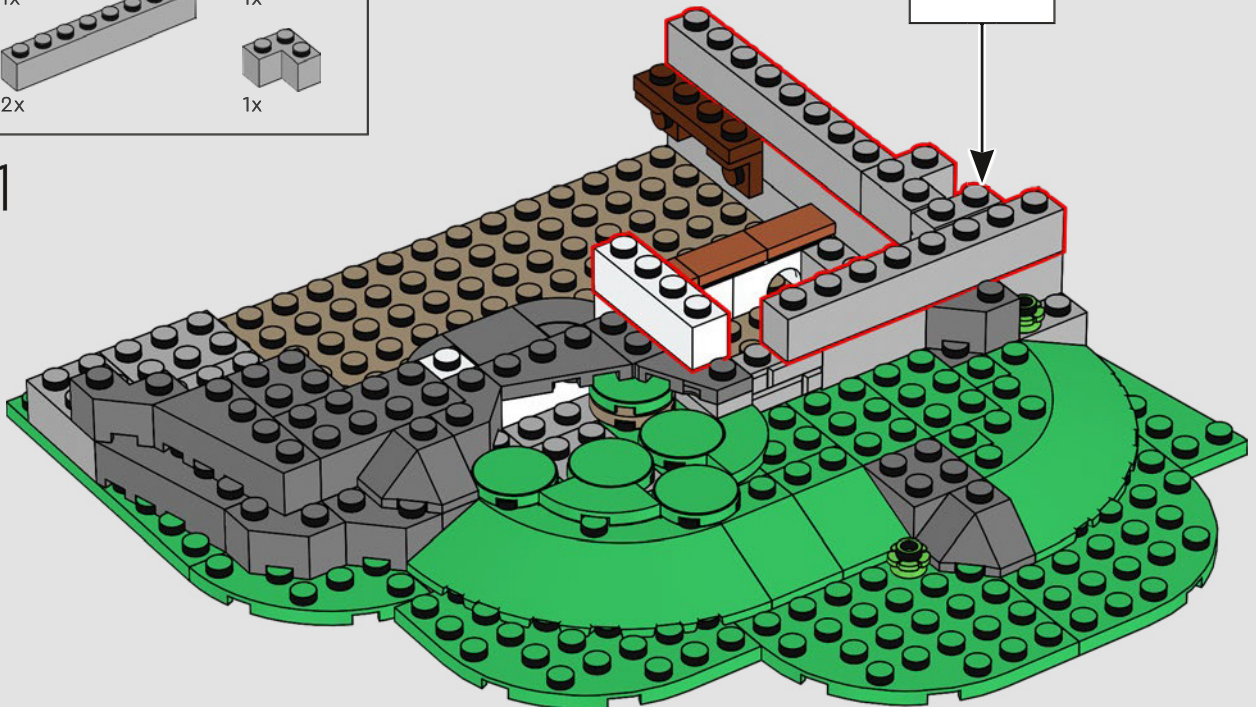
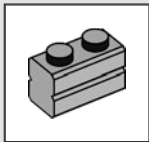

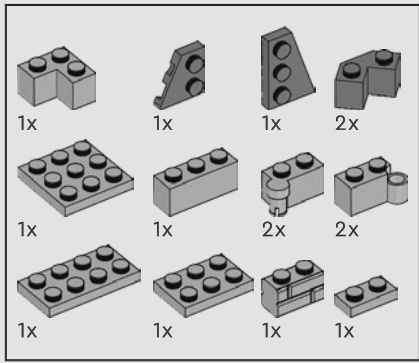

22

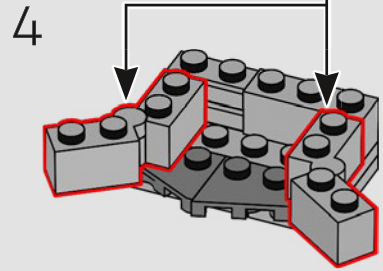
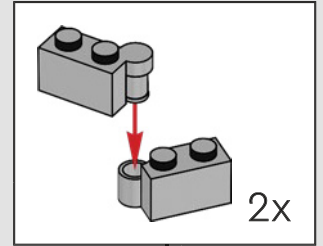
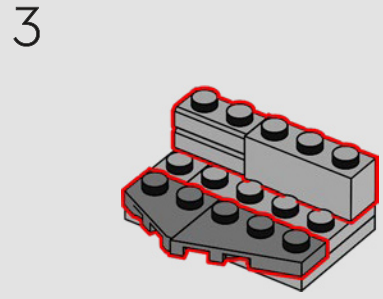
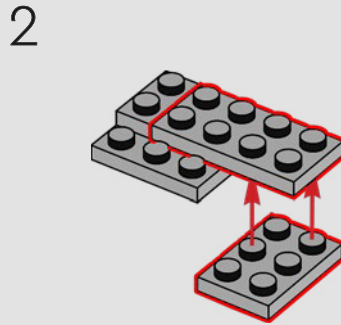
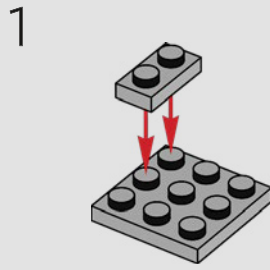

¿Cómo pueden unirse estos muros?
¡Jamás se ha visto tal suerte de
magia como la que hay aquí!

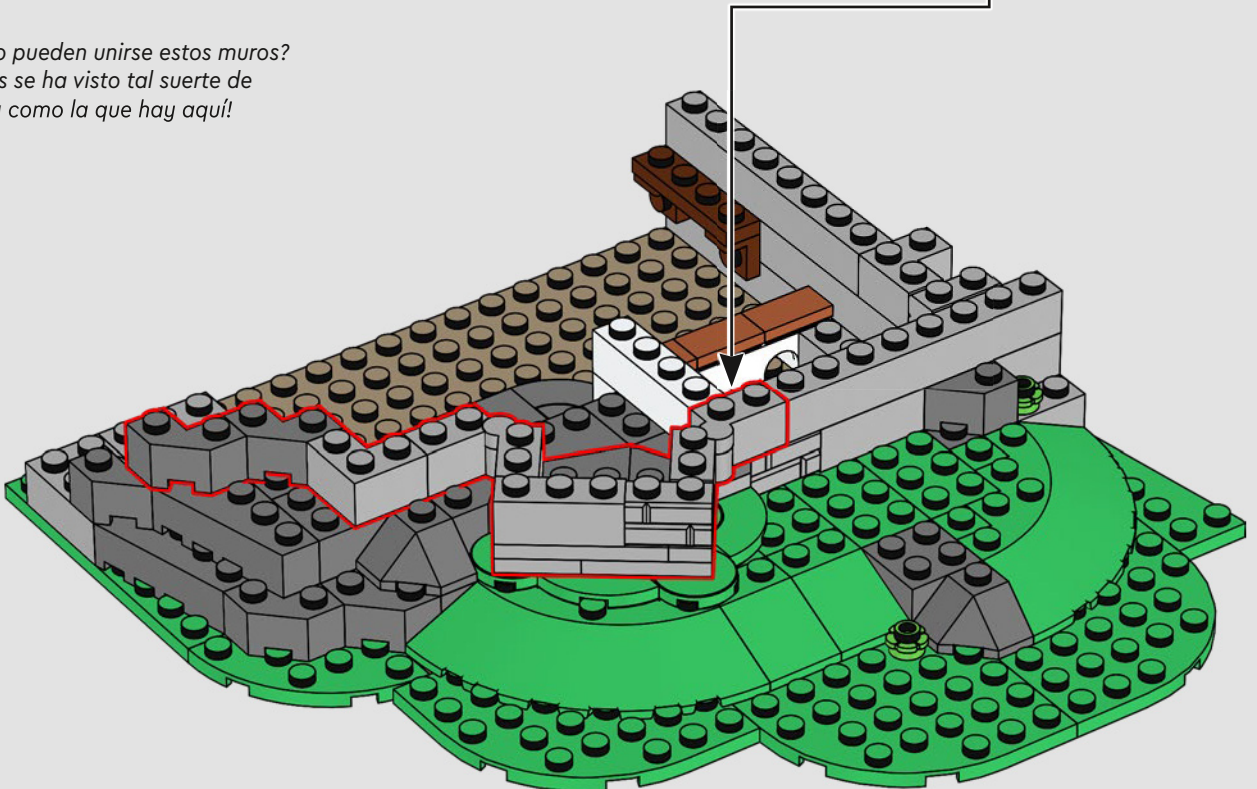

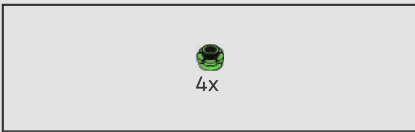

23

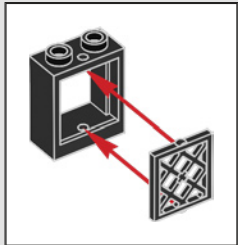
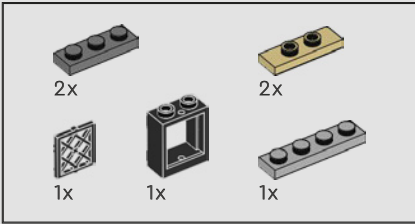
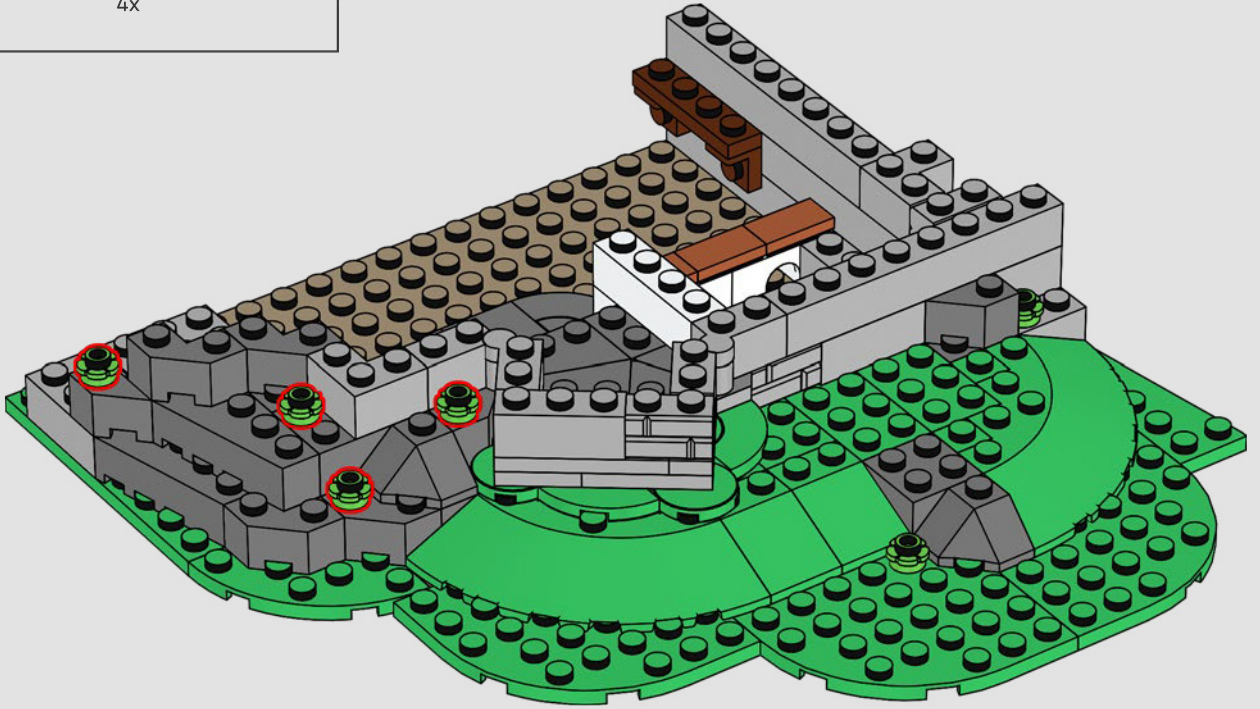

24

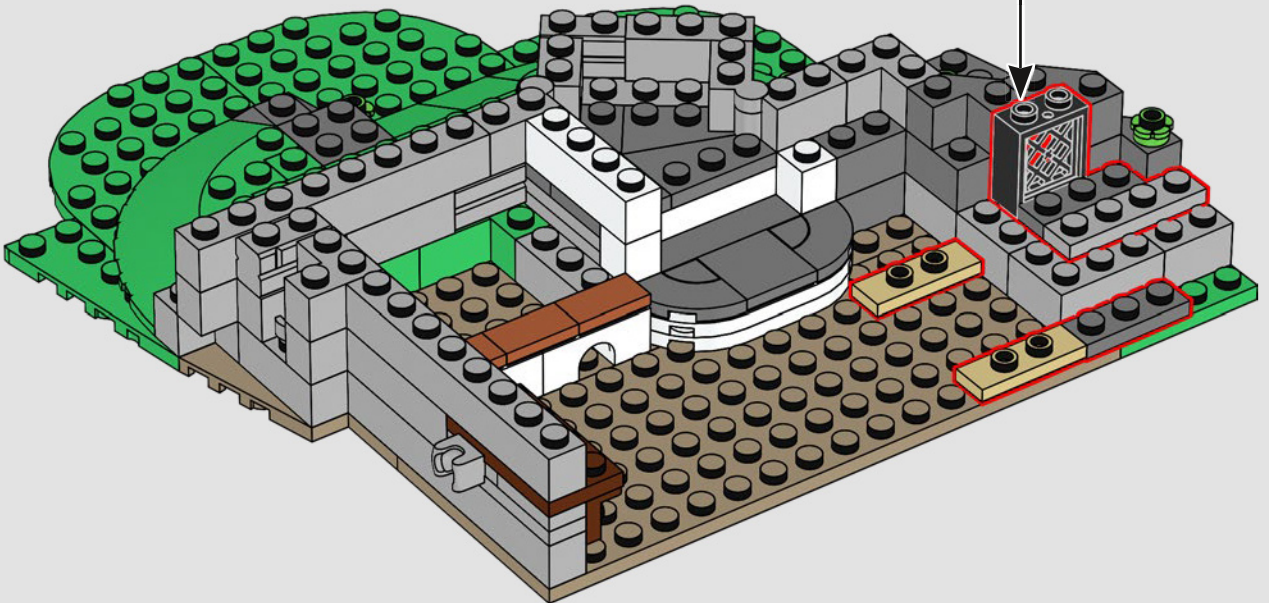



Parece que alguien se sentó en un ladrillo 1x1. Fue eso, ¿o alguien estiró una placa!

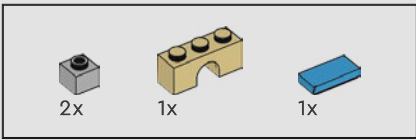

25

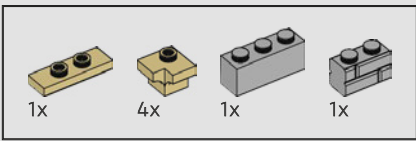
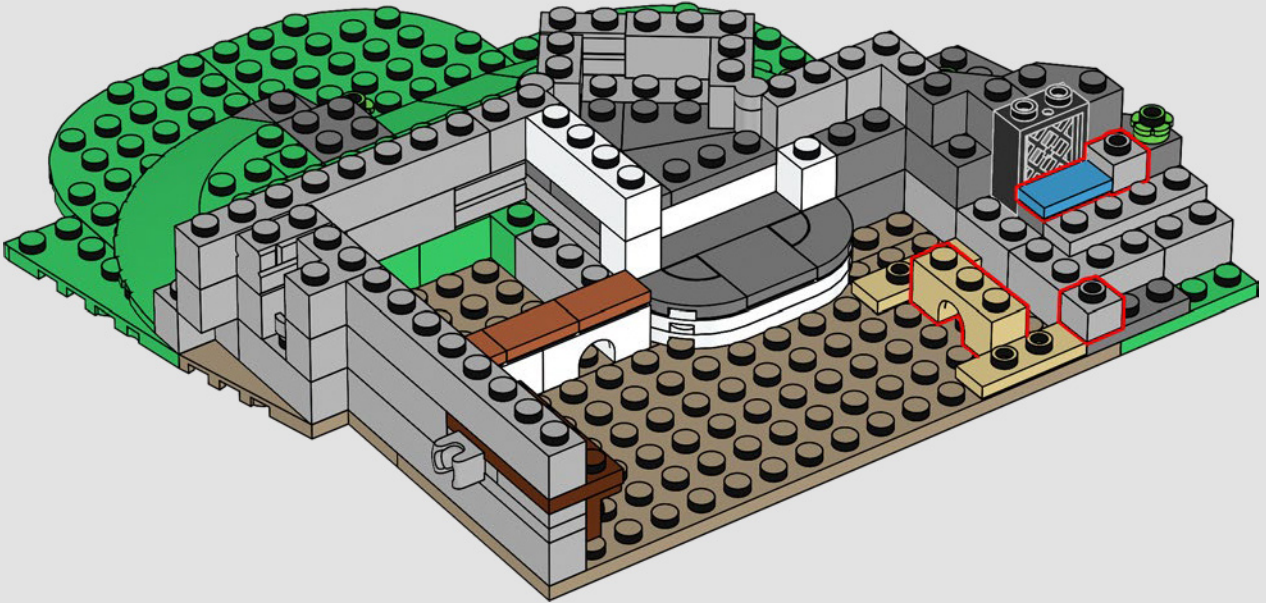

26

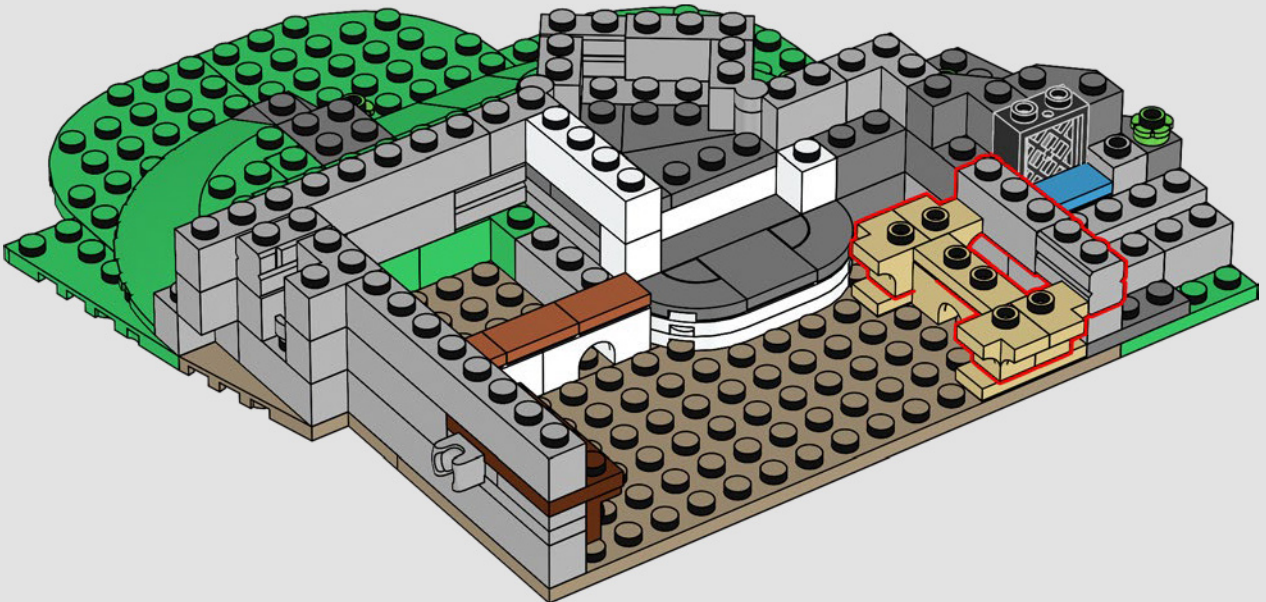

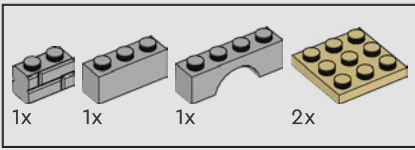

27

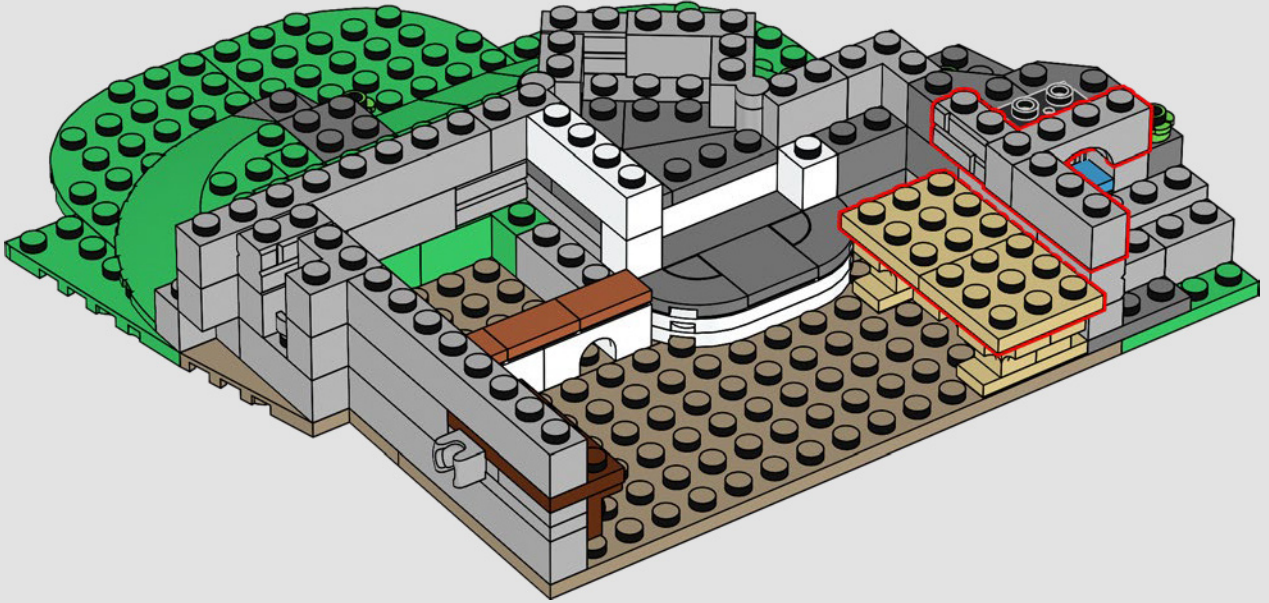

28

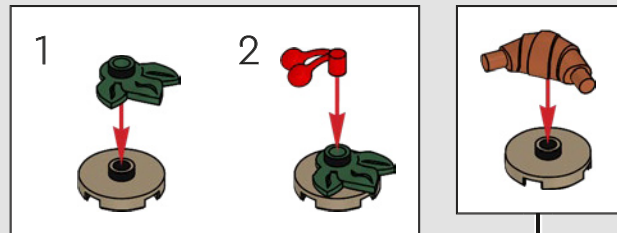

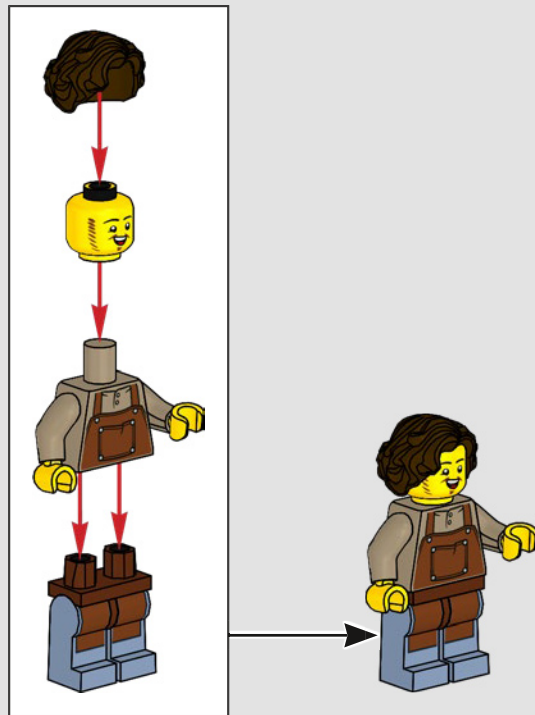



Extraño lugar para encender una vela. ¿Qué es lo que ilumina?

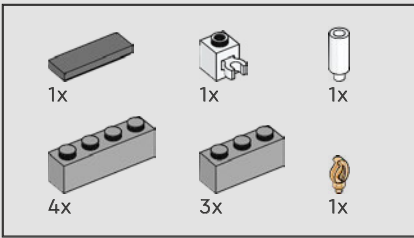

29

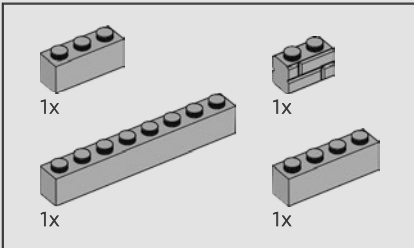
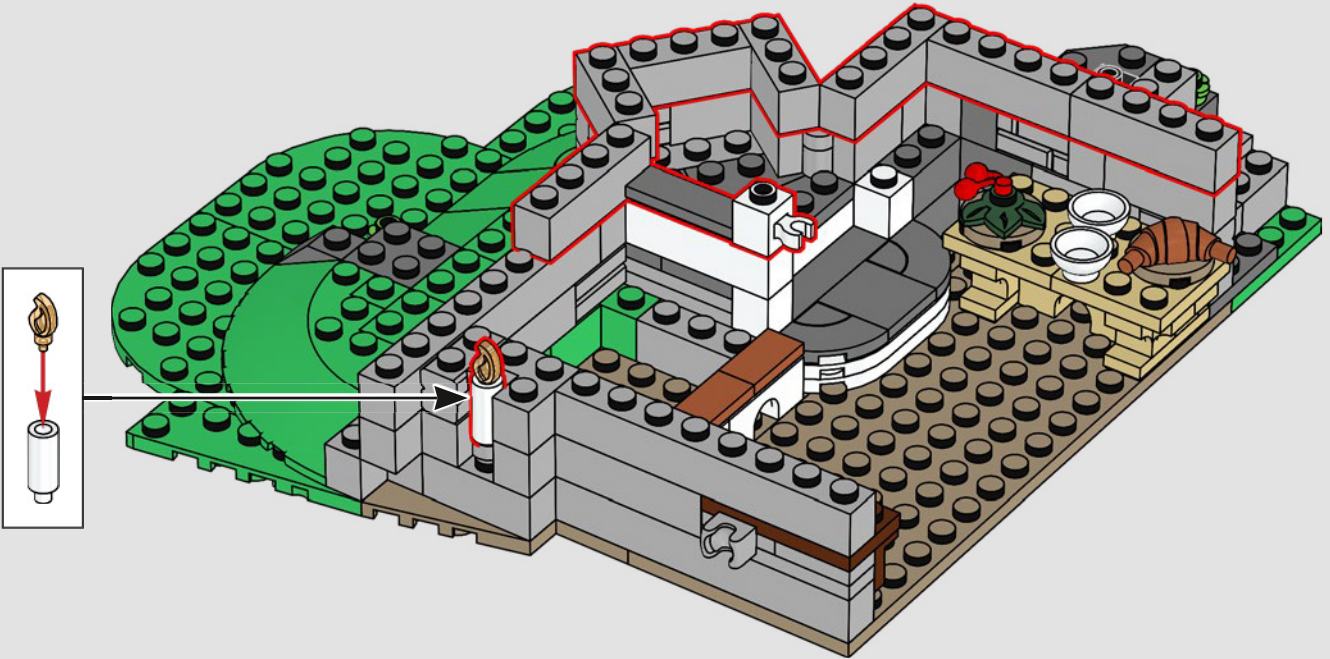

30

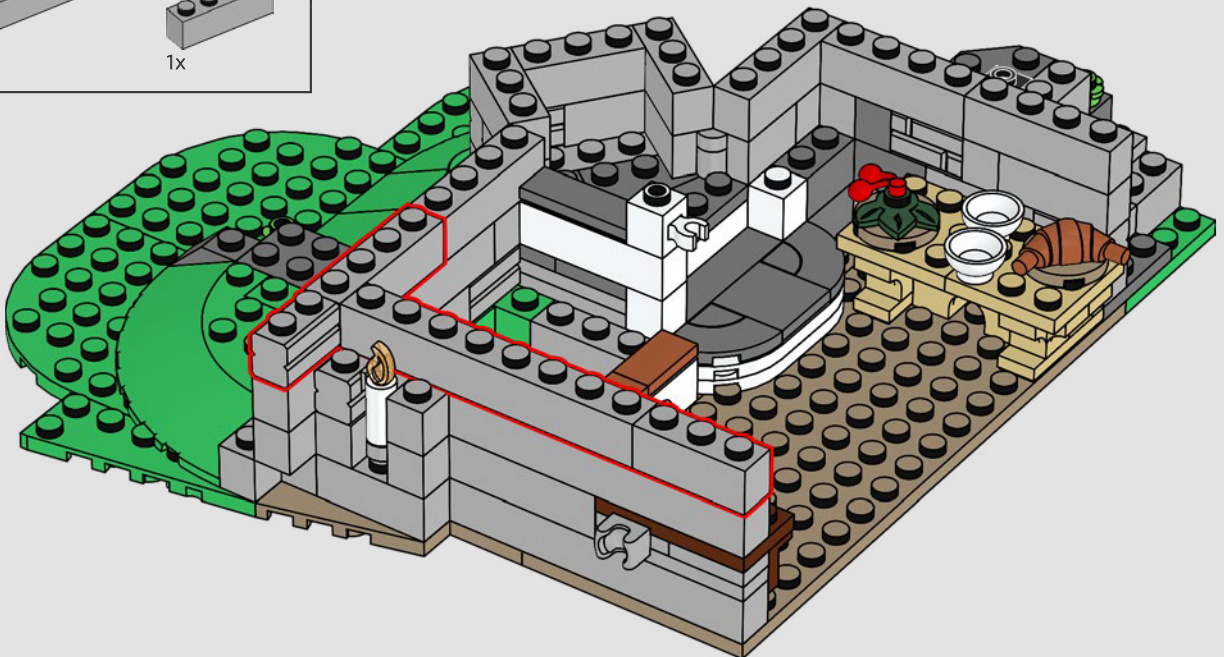

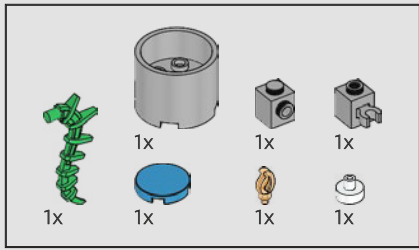

31

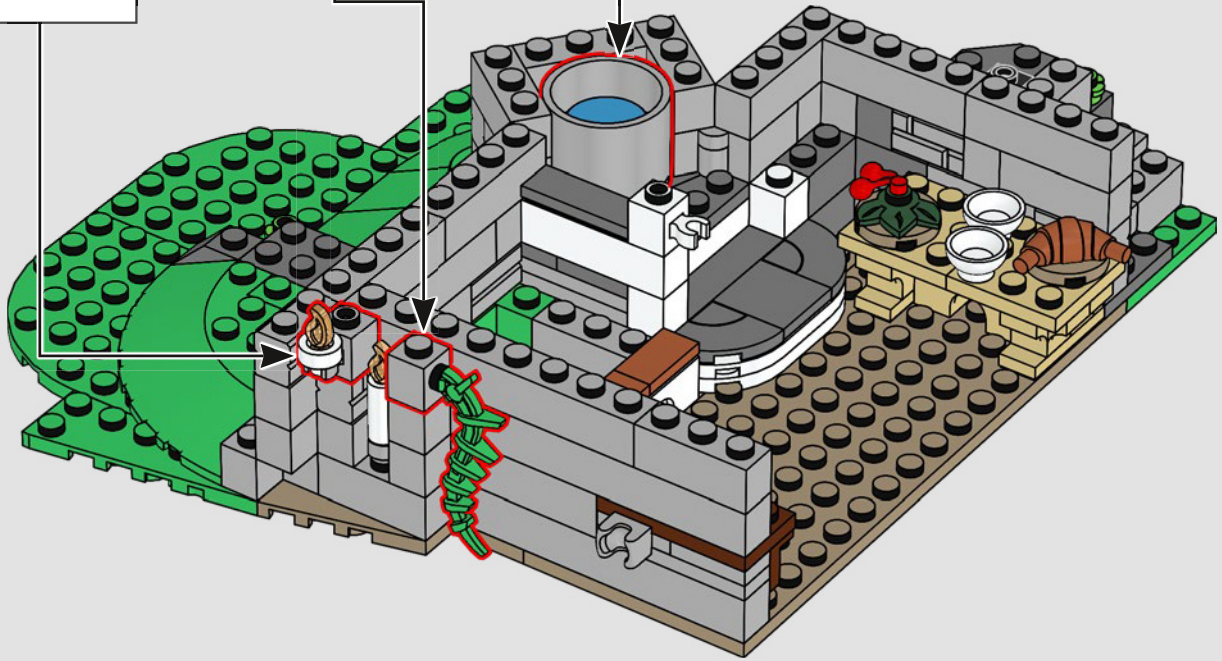
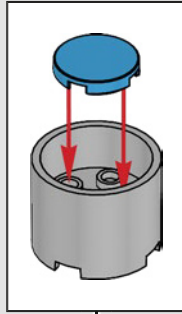
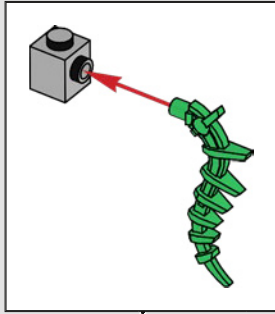
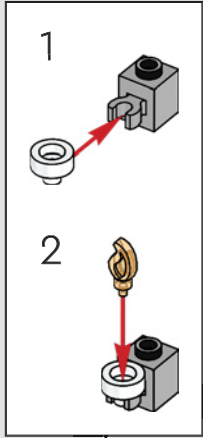

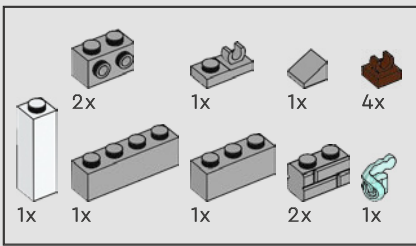

32

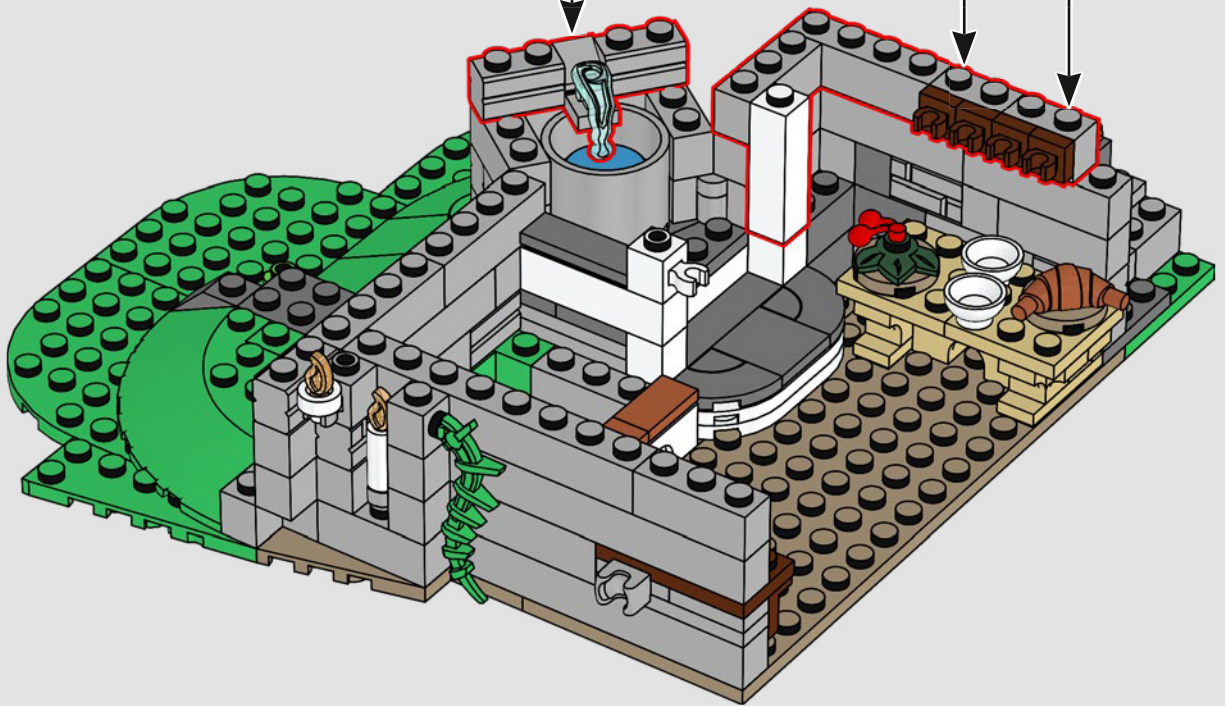
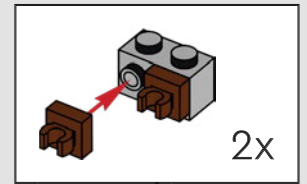
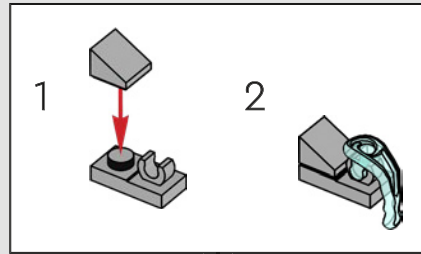

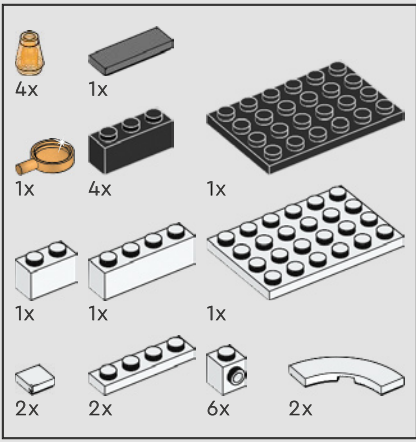

33

1

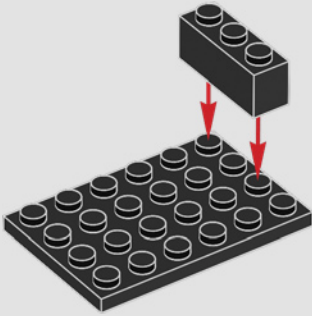

2

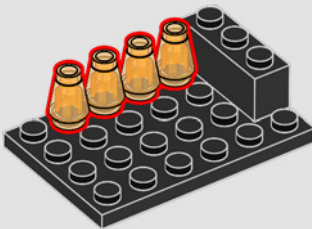

3

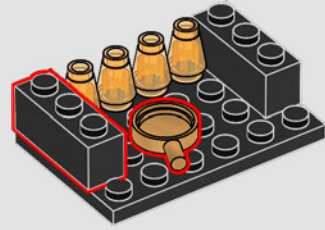

4

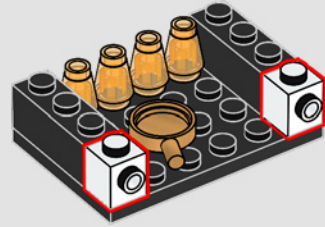

5

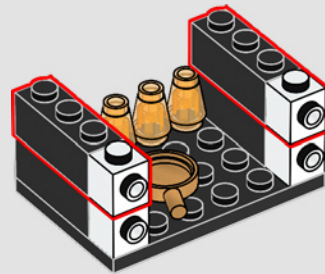

6

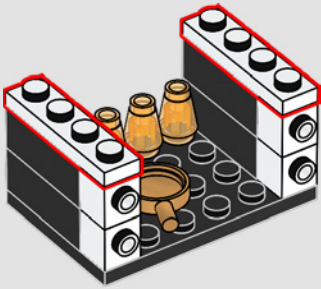

8

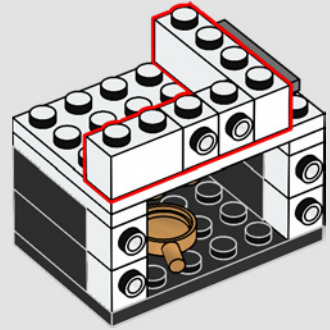

7

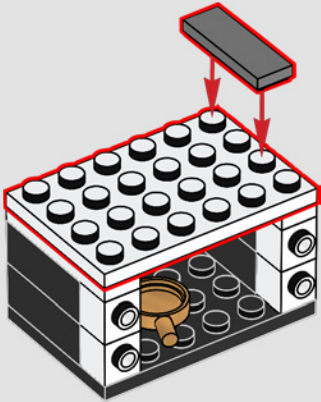

9

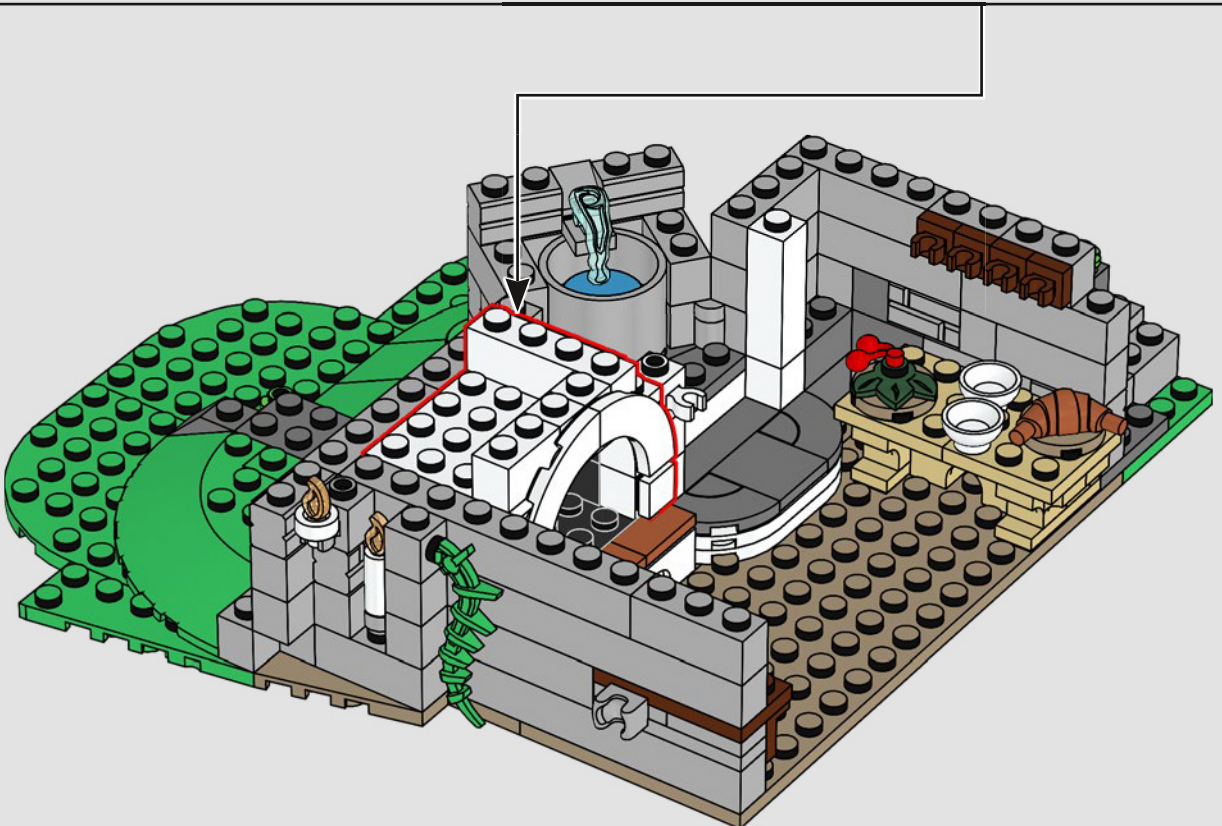
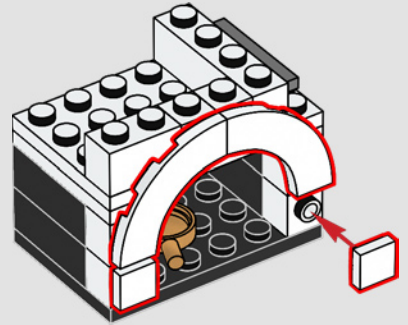

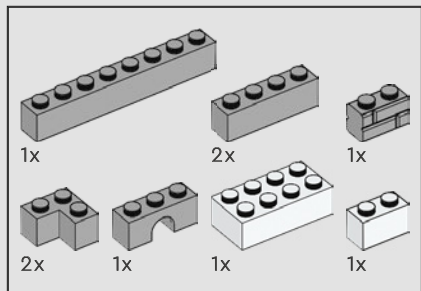

34

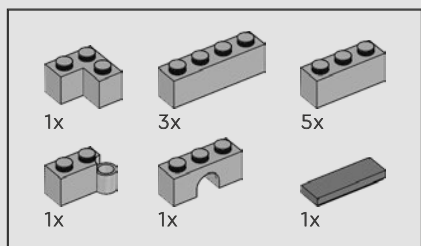
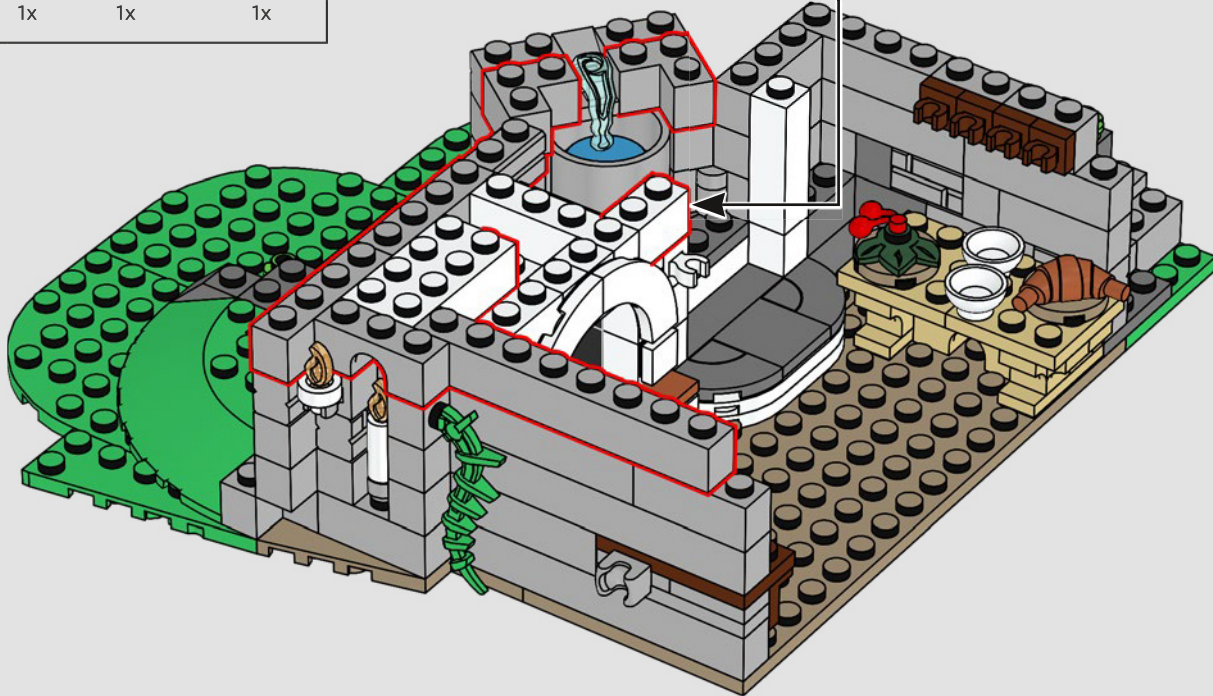

35

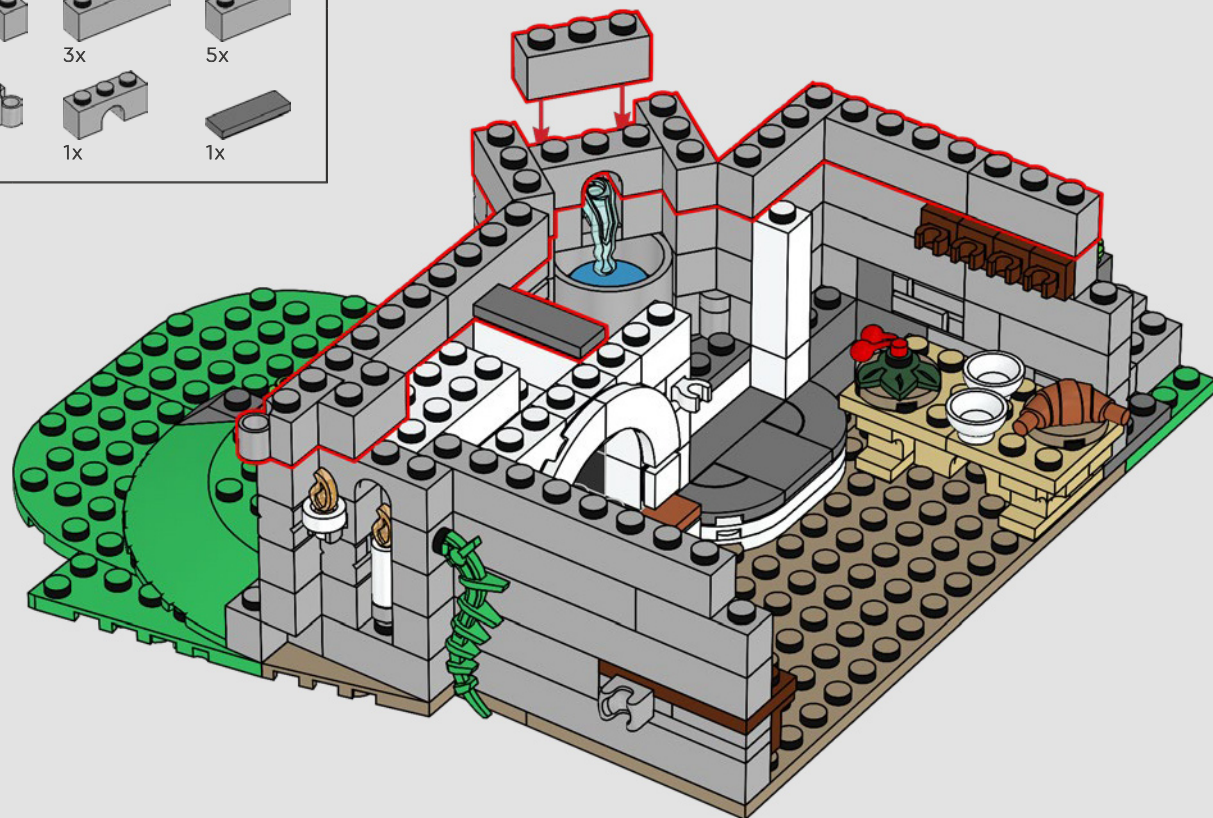

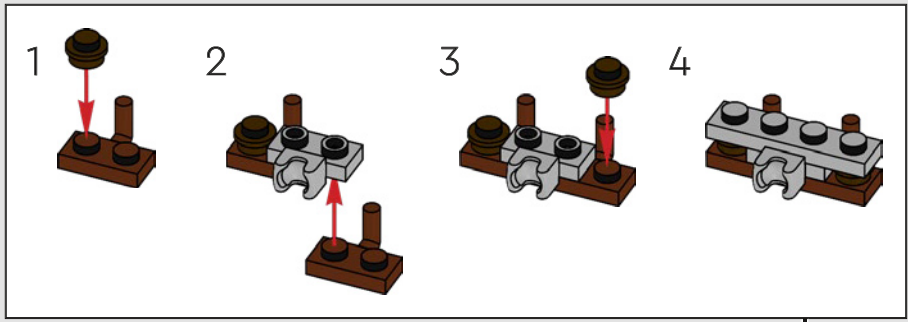
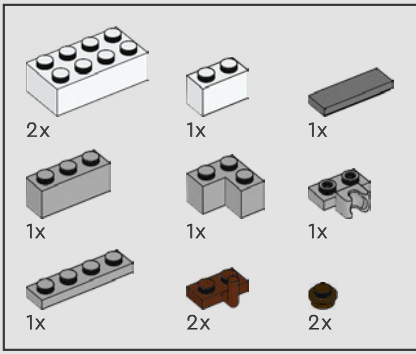

36

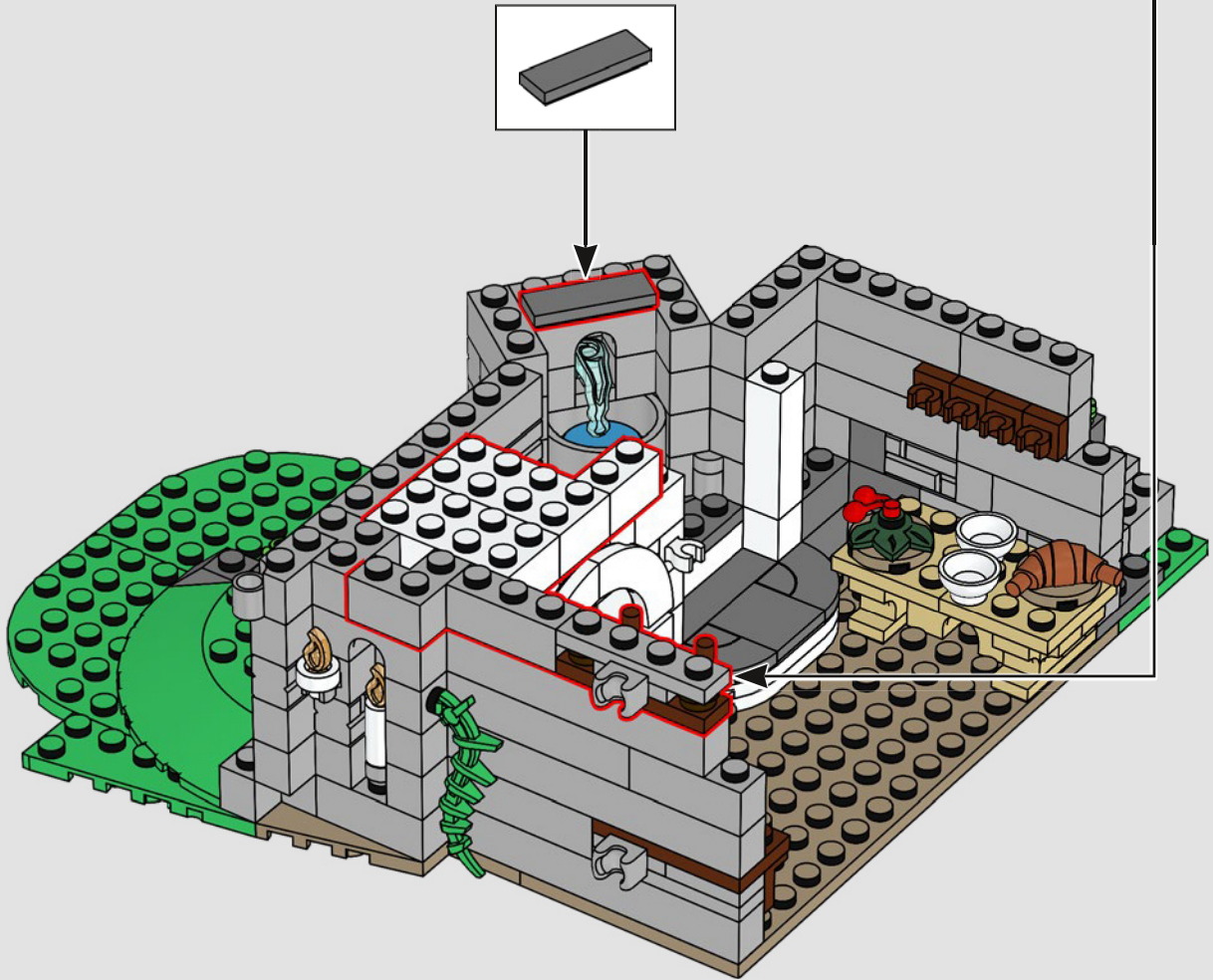

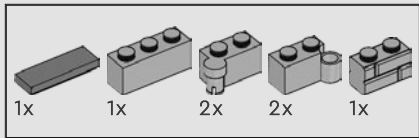

37

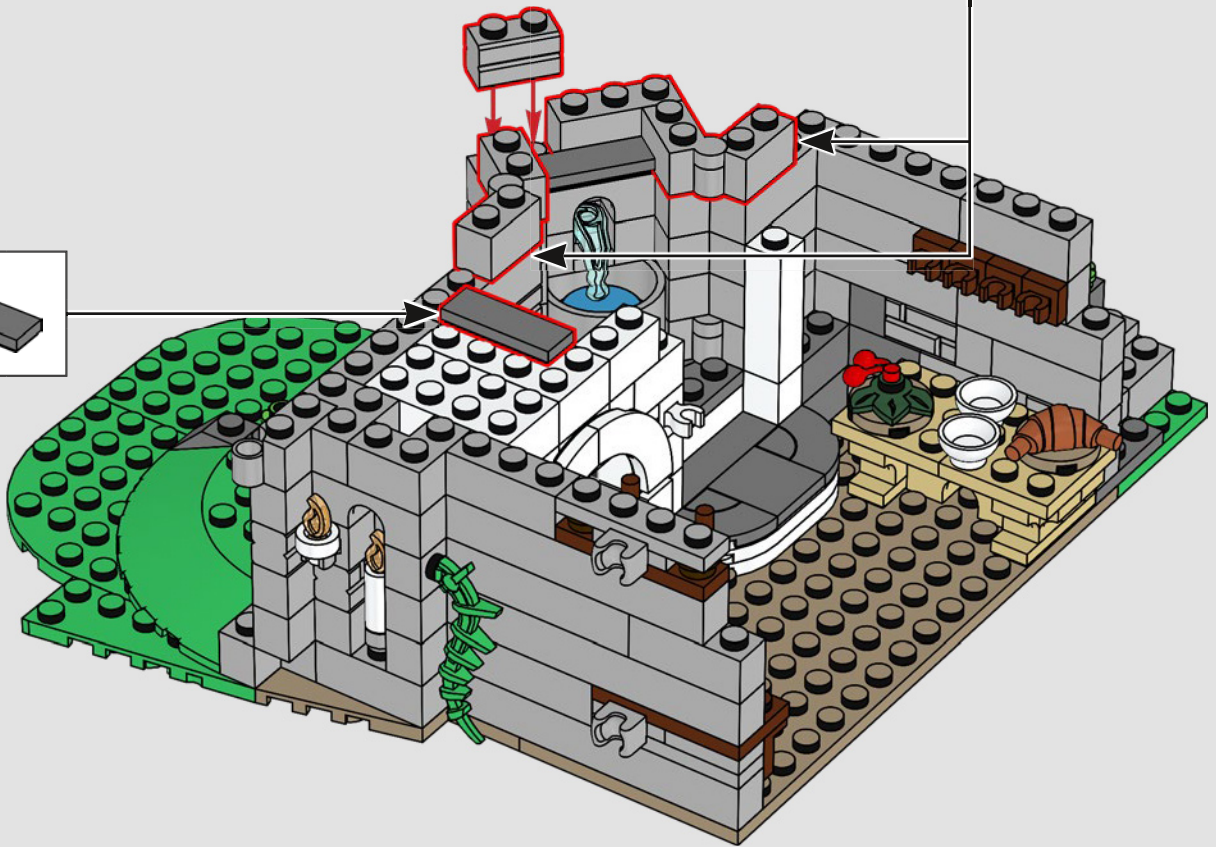
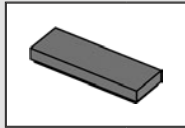
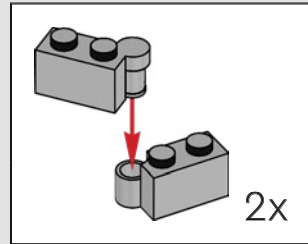

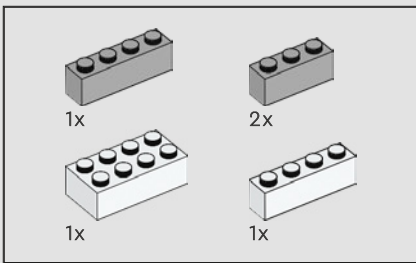

38

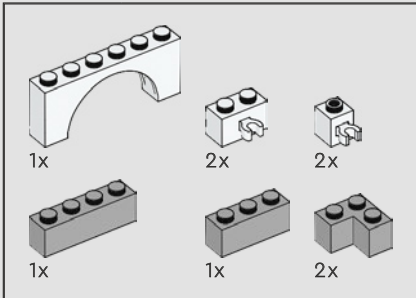
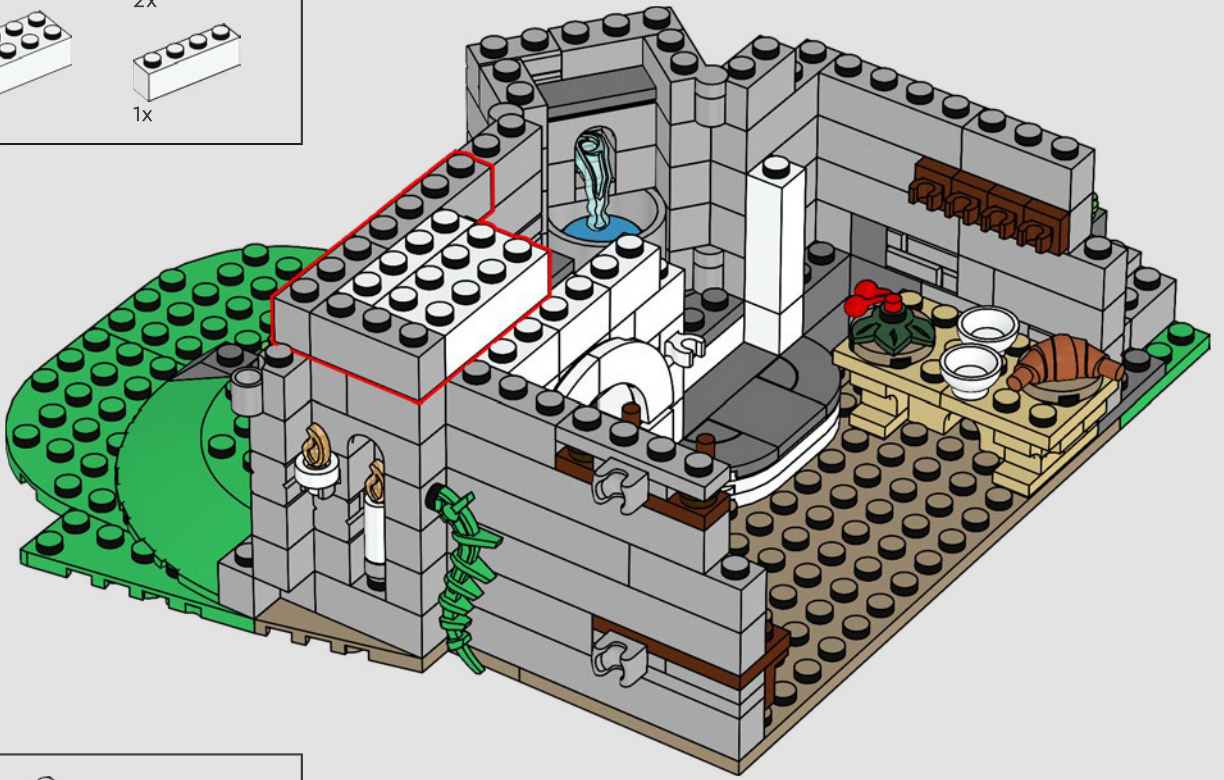

39

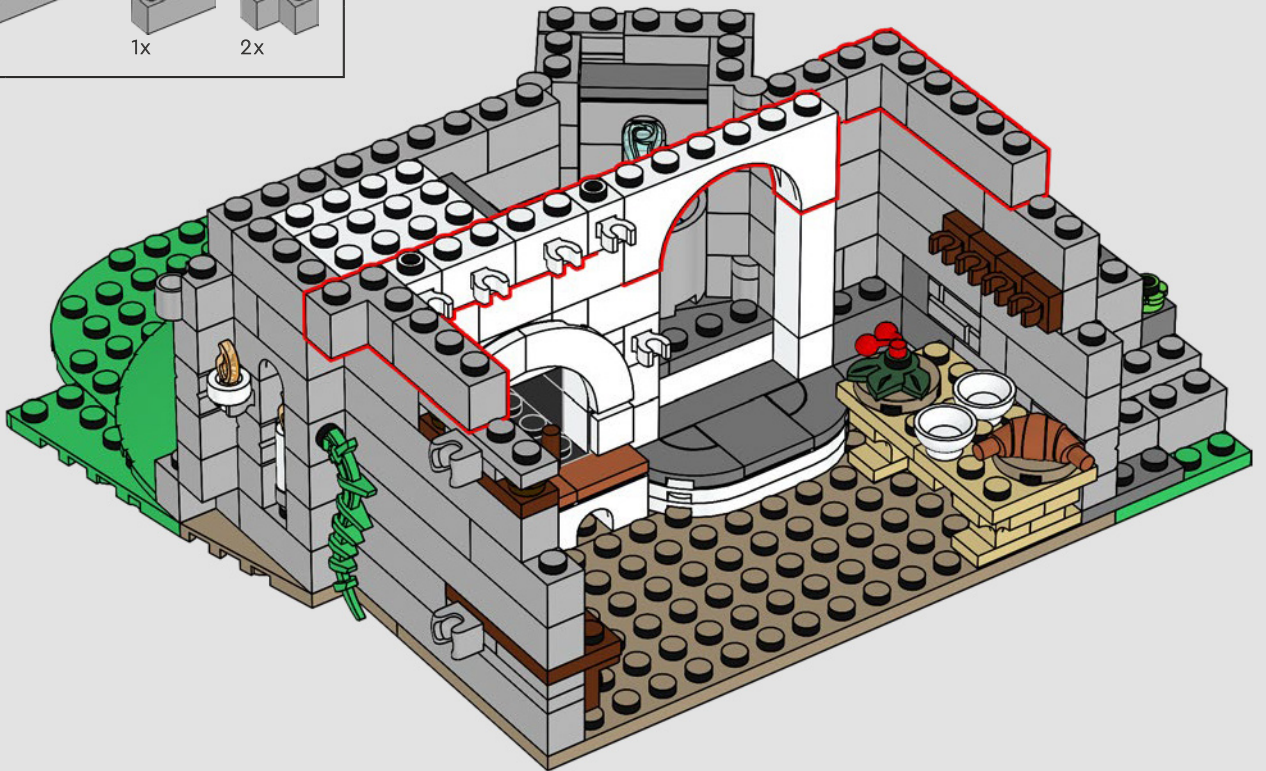



40

1

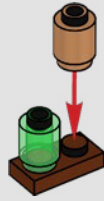

2

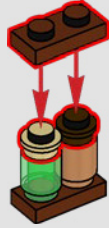

3



4



5



6





¿Esos son nabos o zanahorias? Si tan solo no se parecieran tanto sus colores.

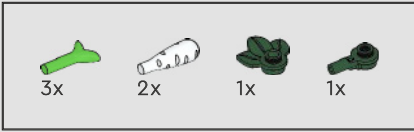

41

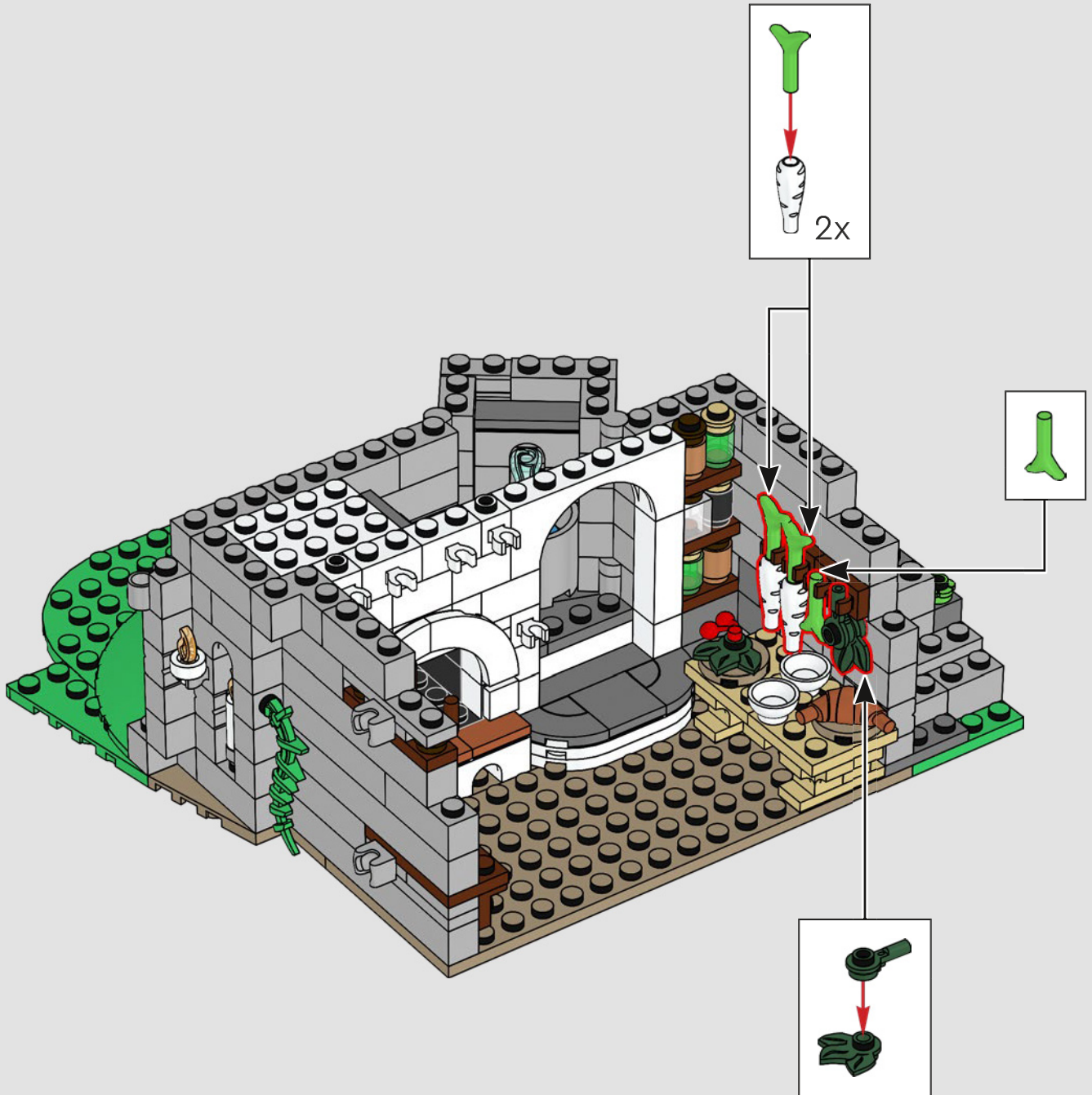

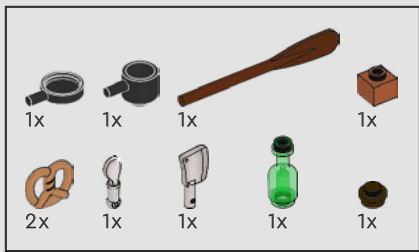

42

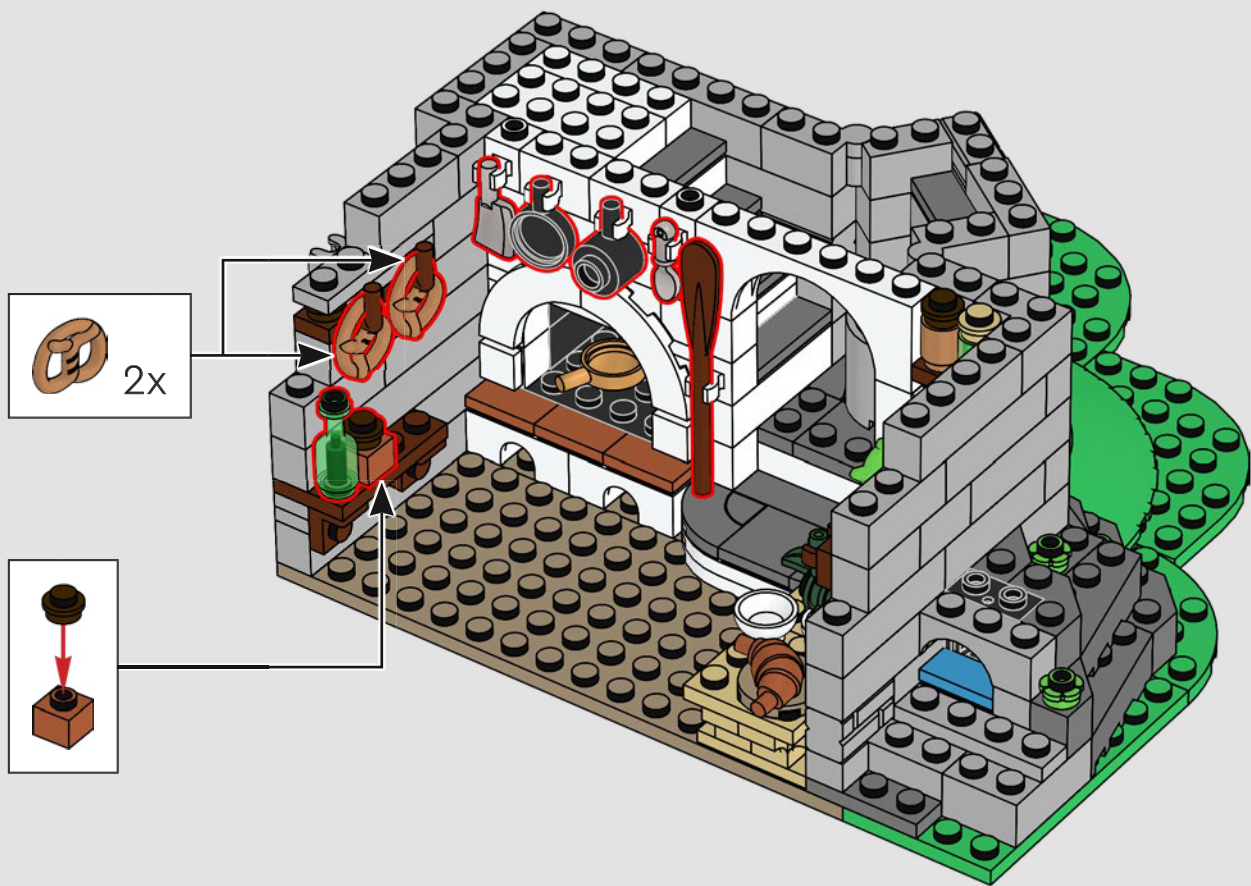

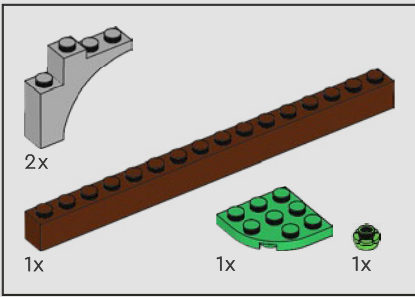

43

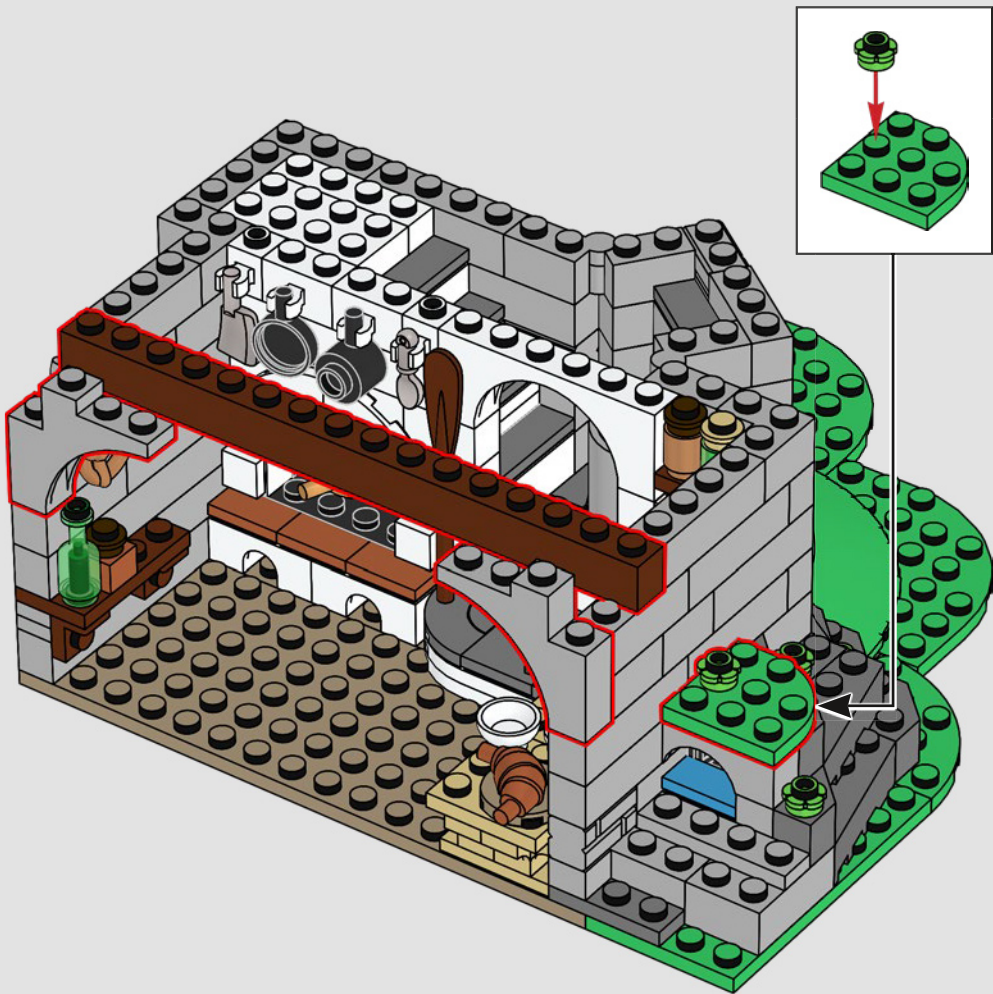

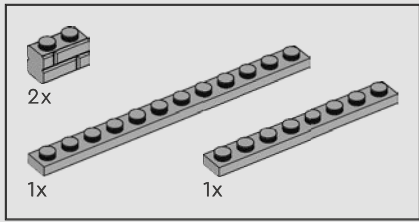

44

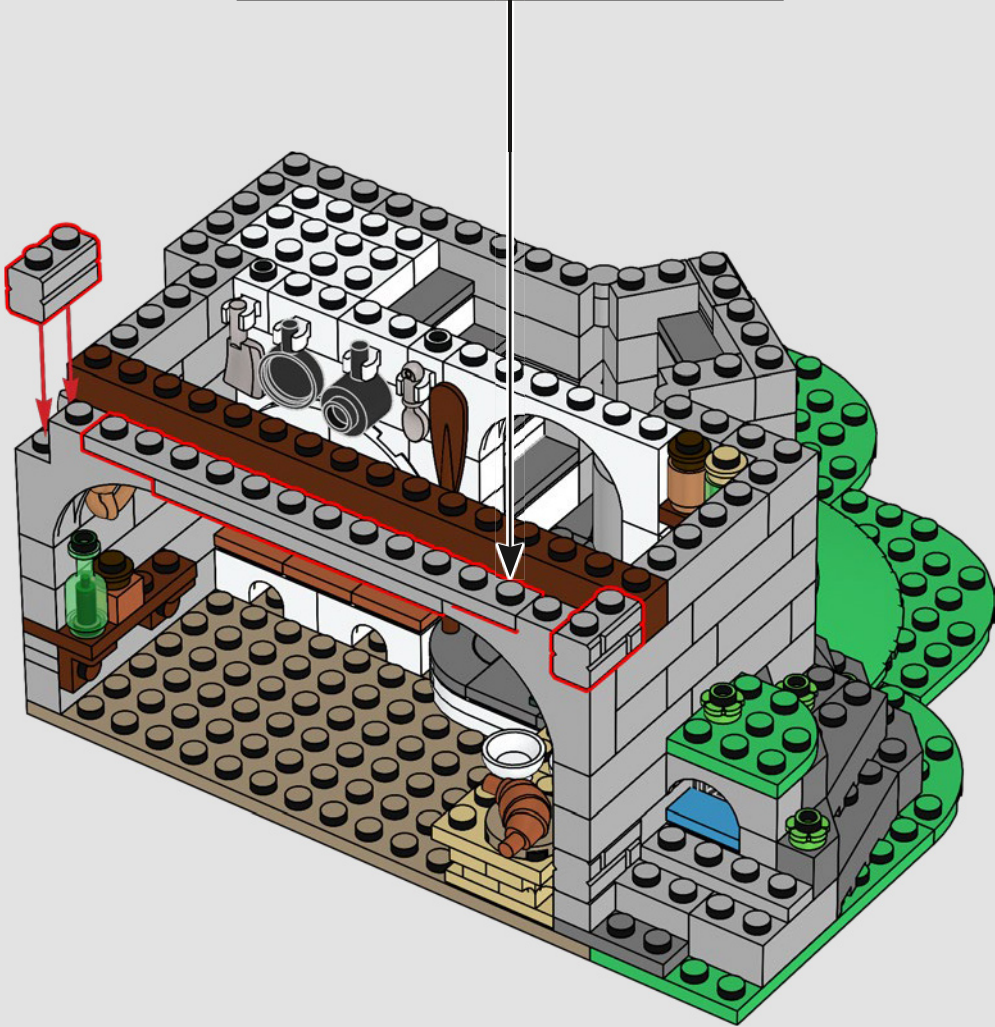
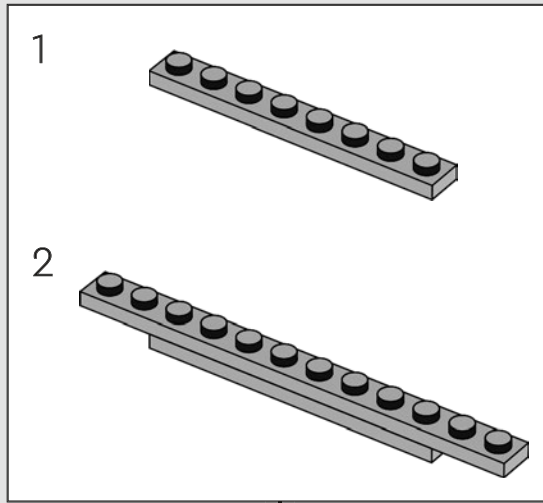

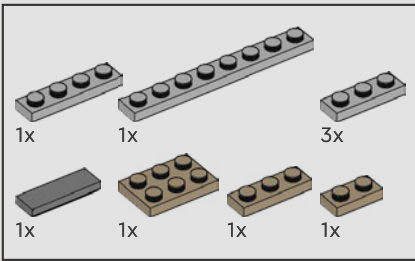

45

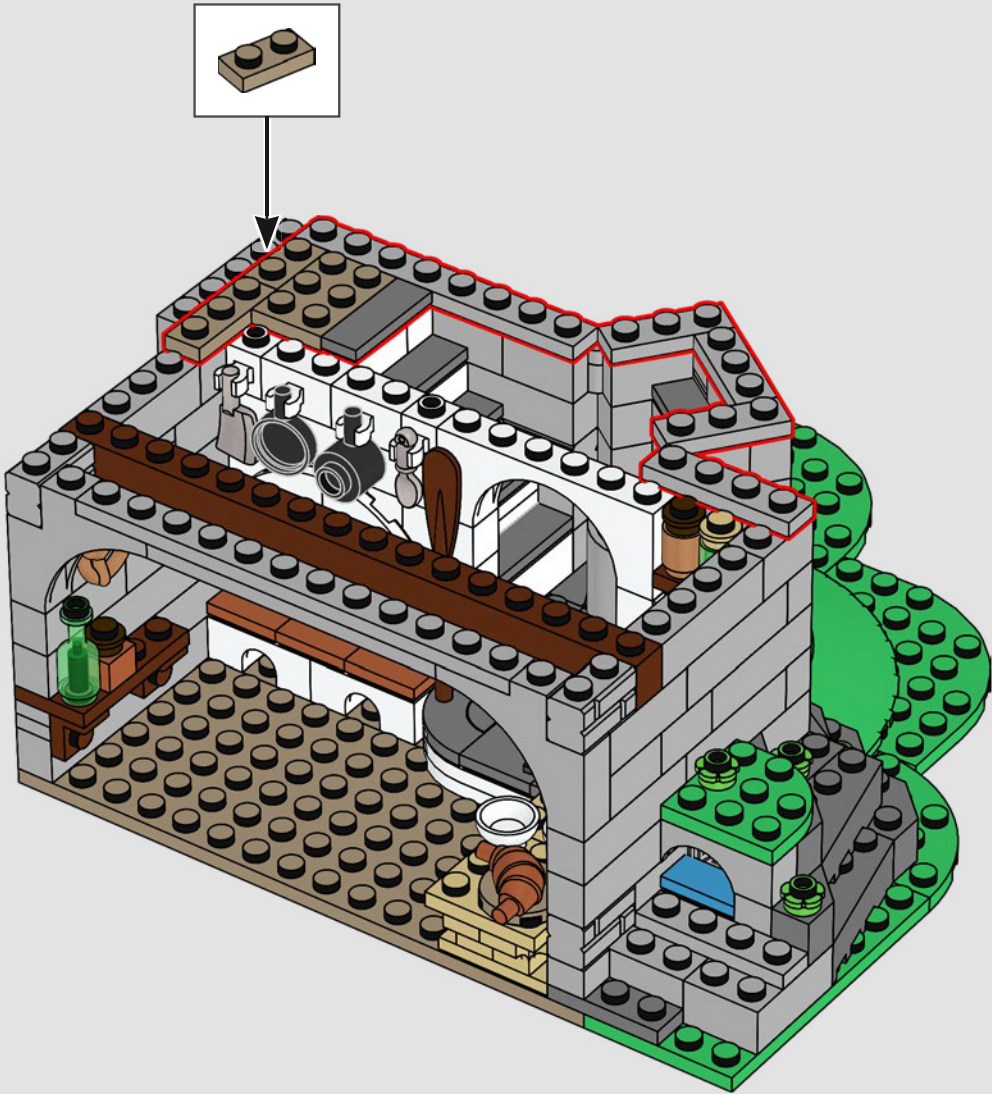

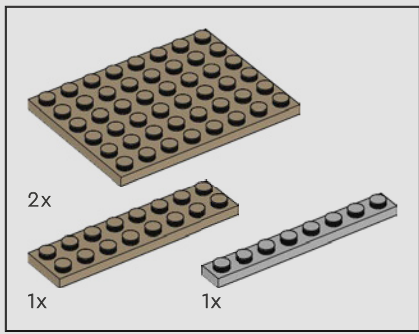

46

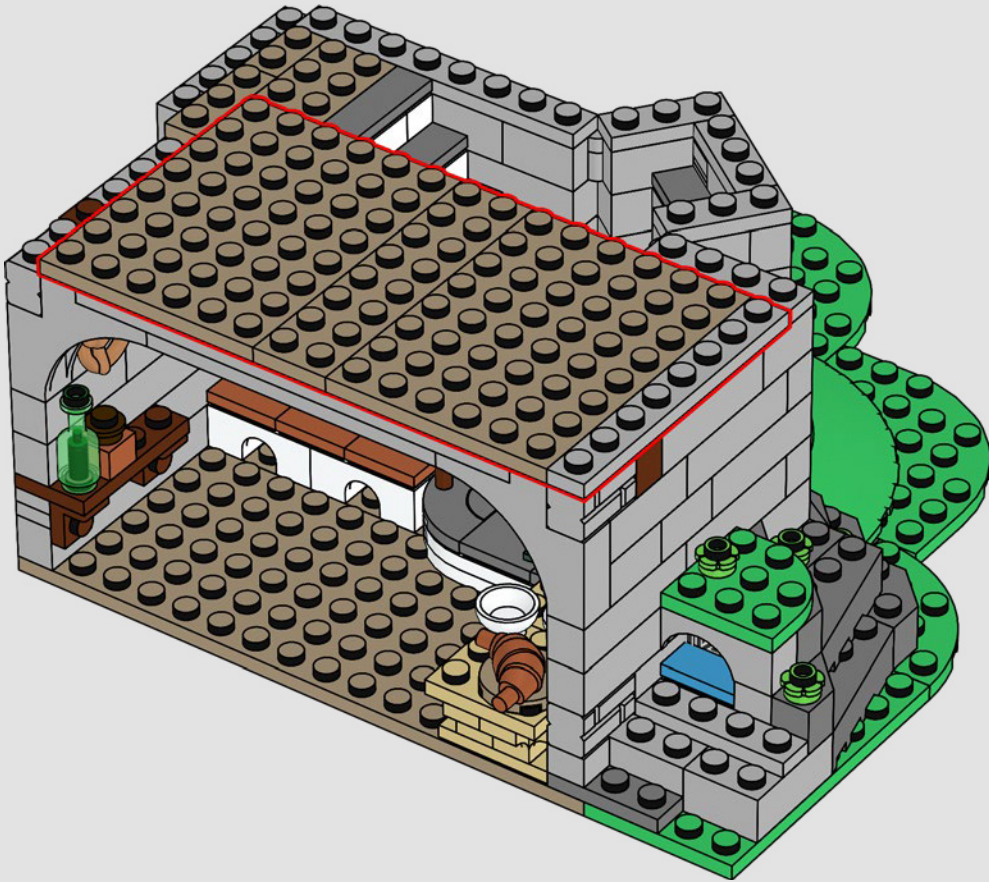

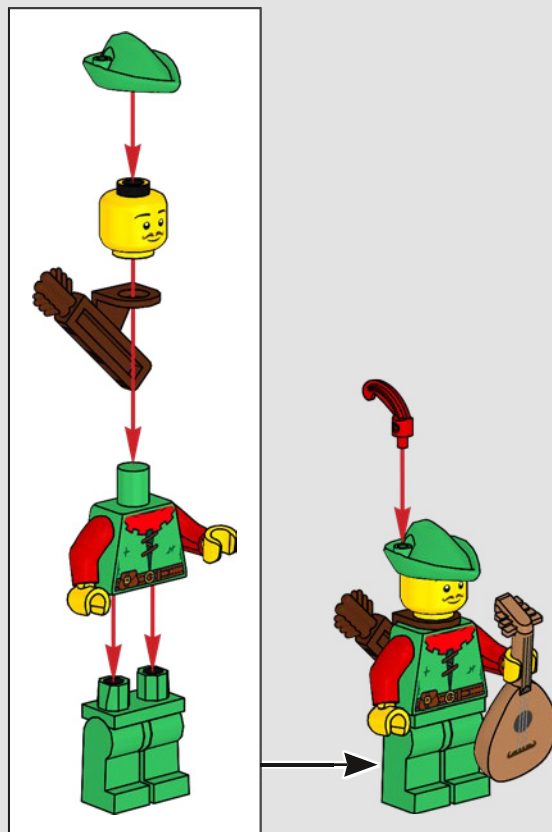

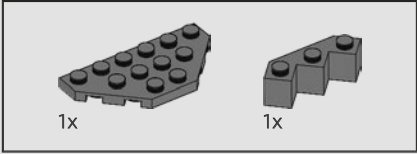
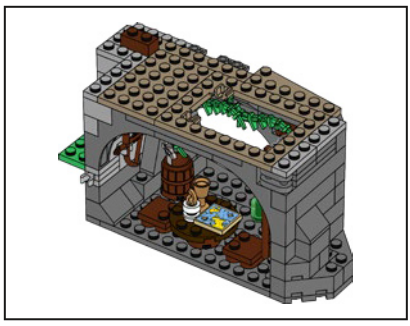

47

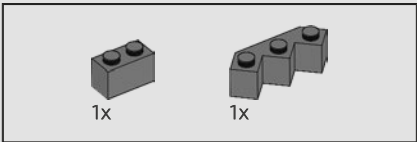
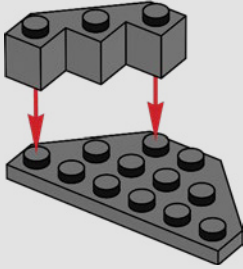

48

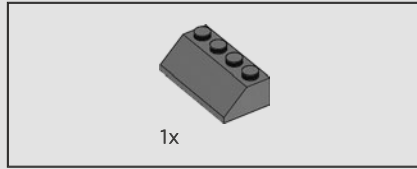
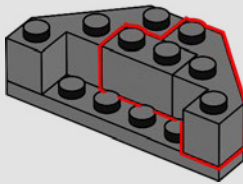

49

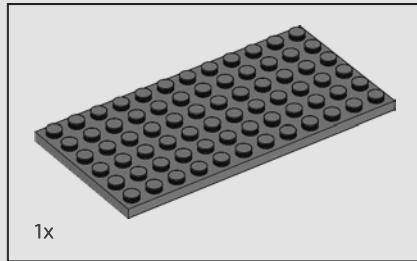
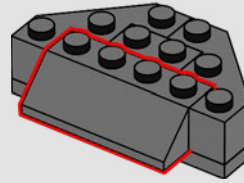

50

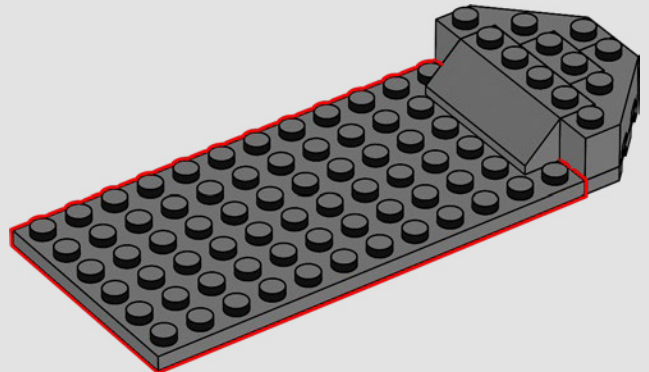

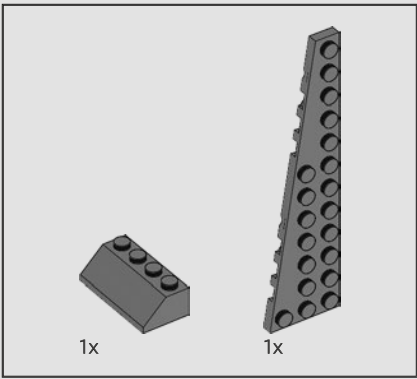

51

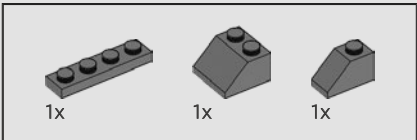
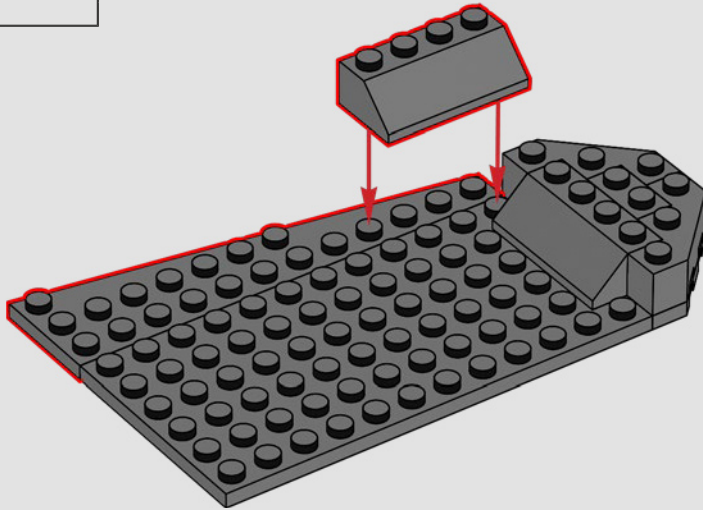

52

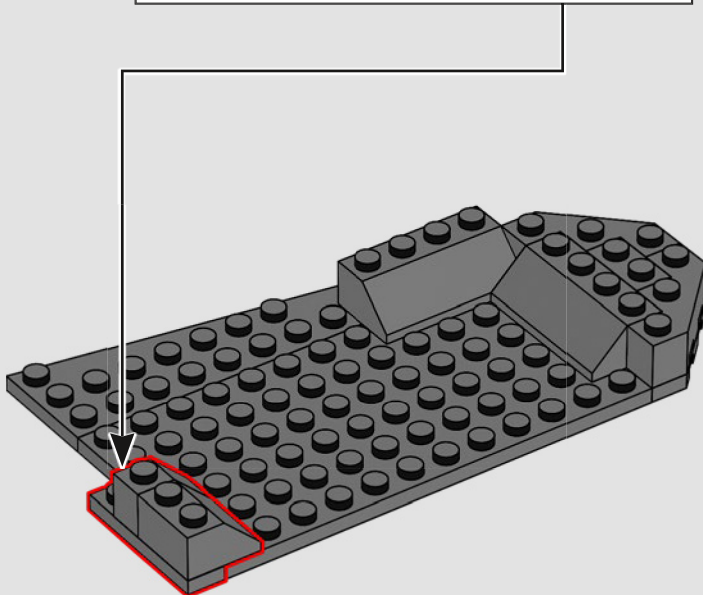
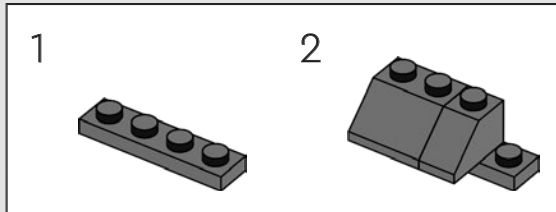

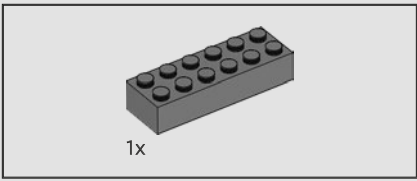

53

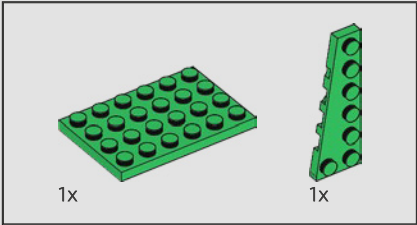
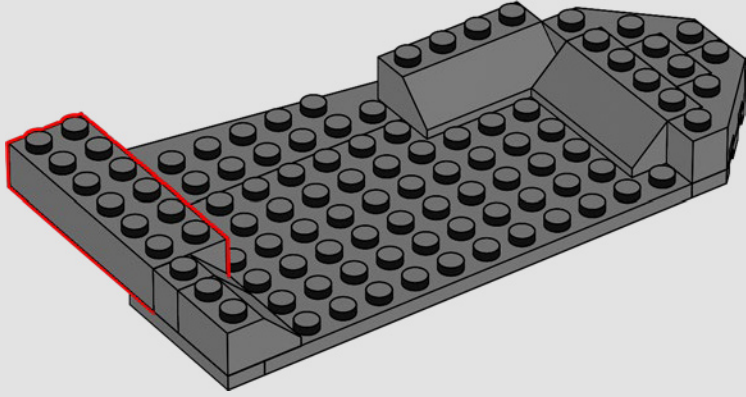

54

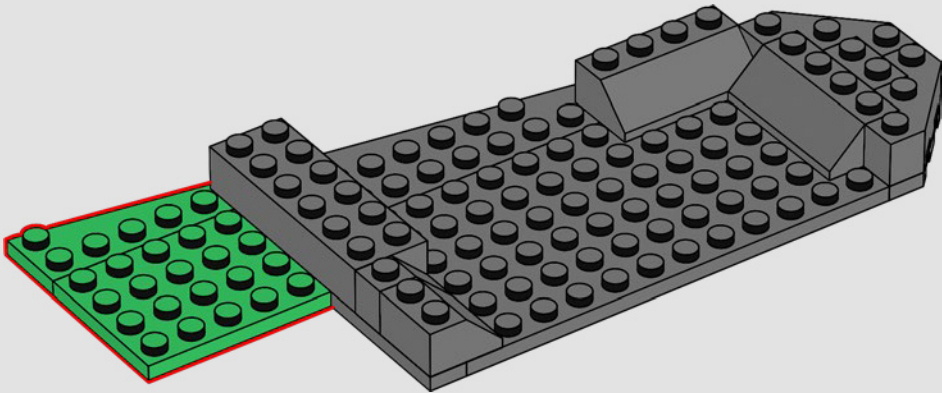

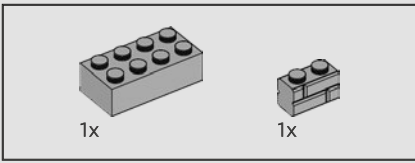

55

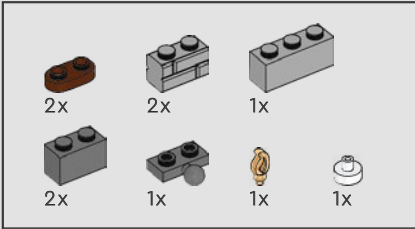
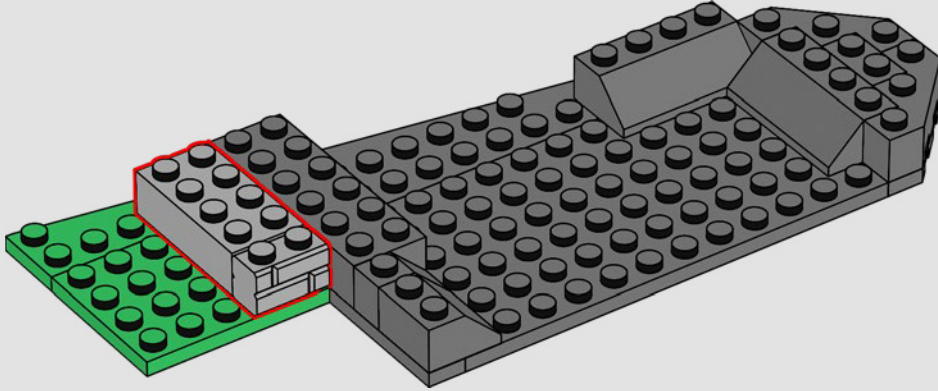

56

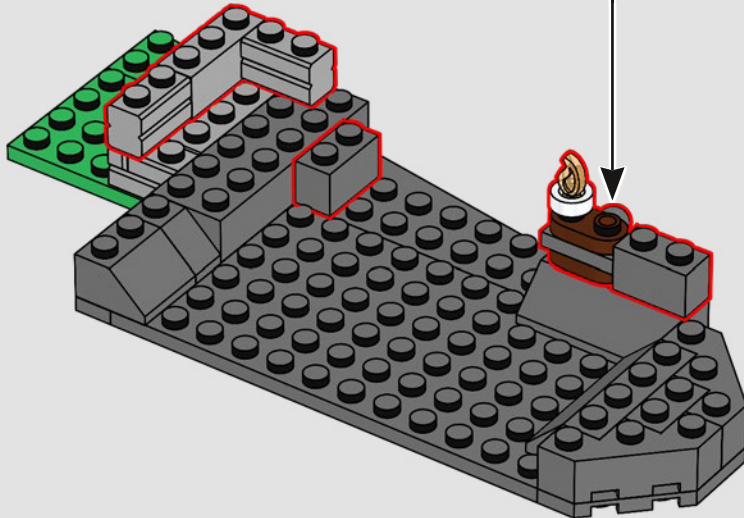
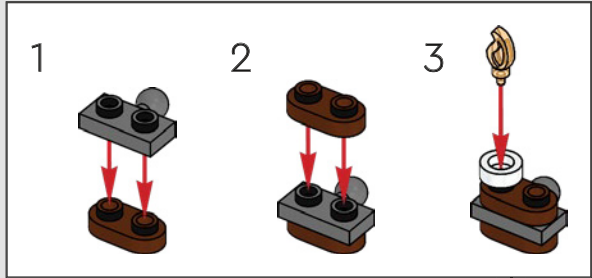

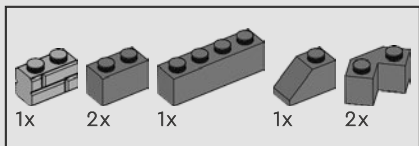

57

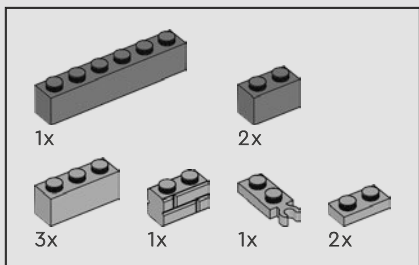
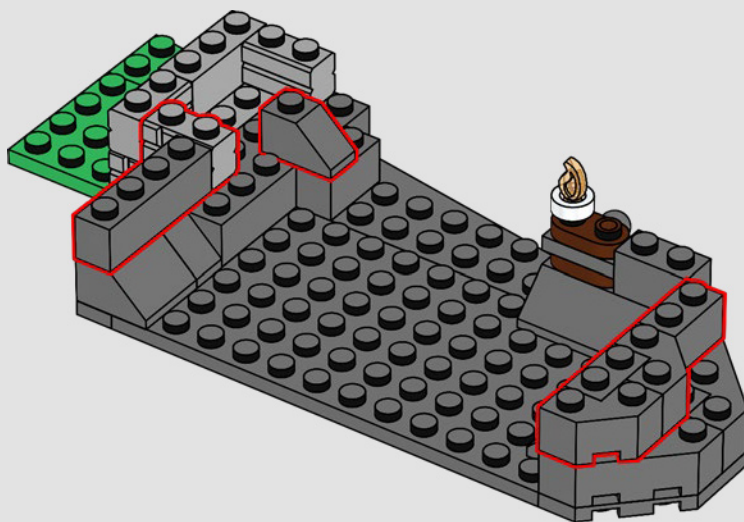

58

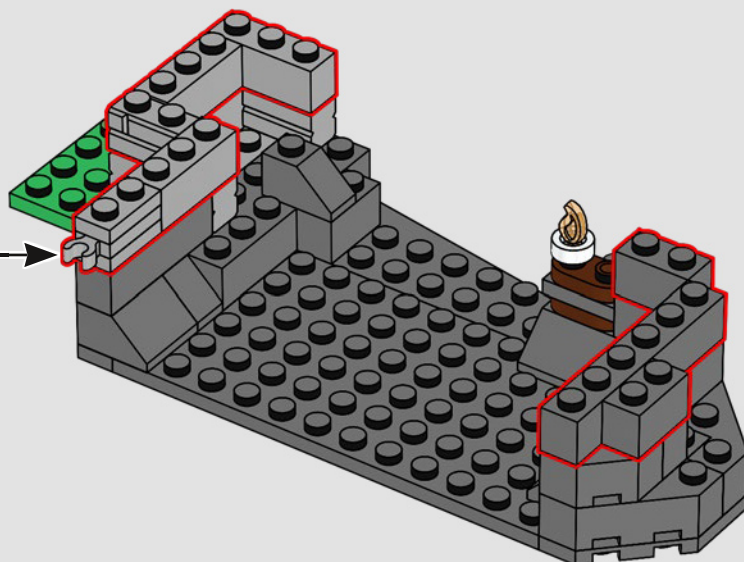
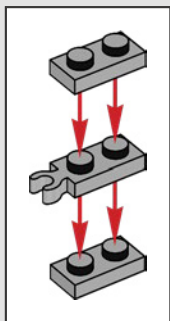

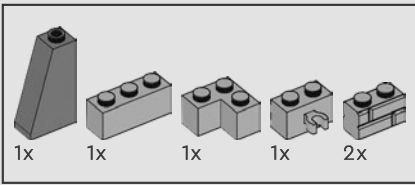

59

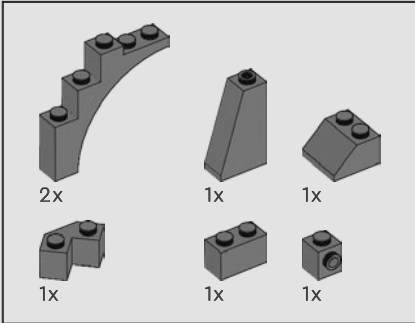
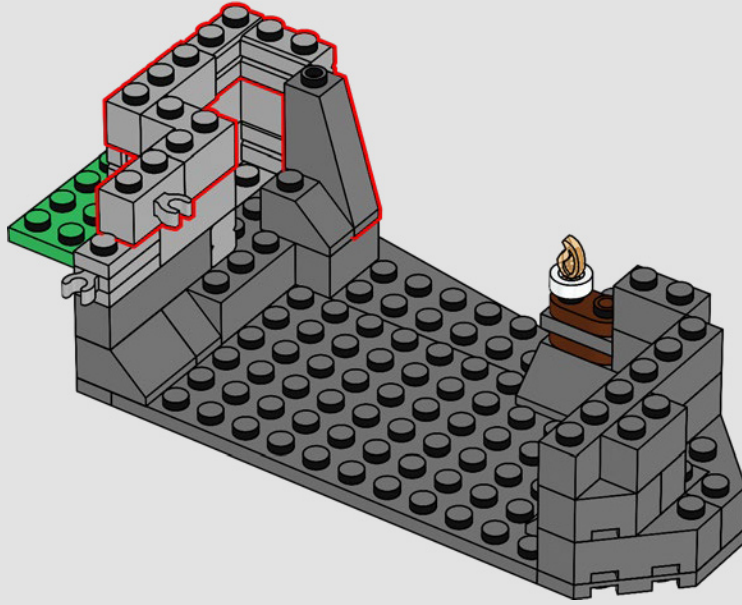

60

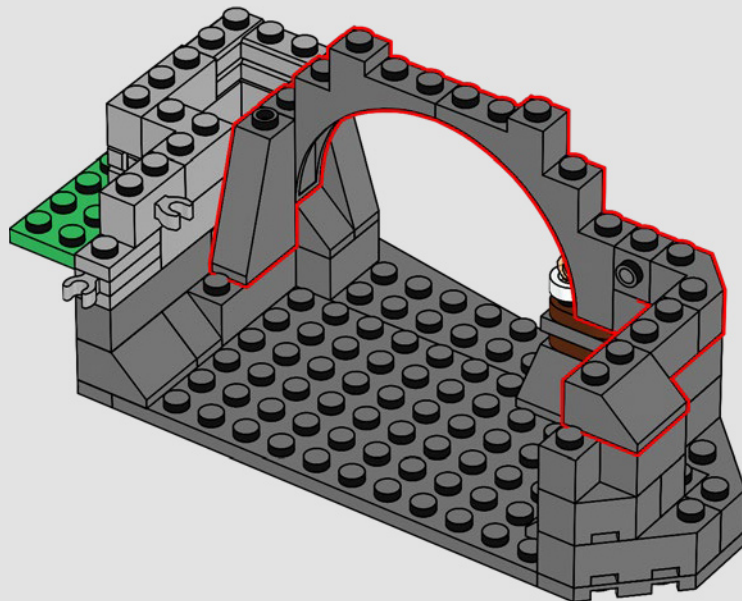

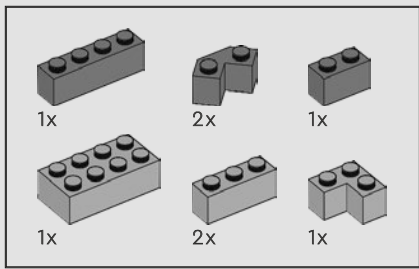

61

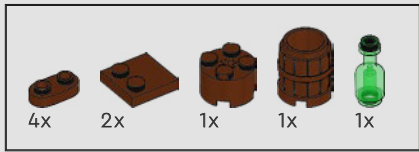
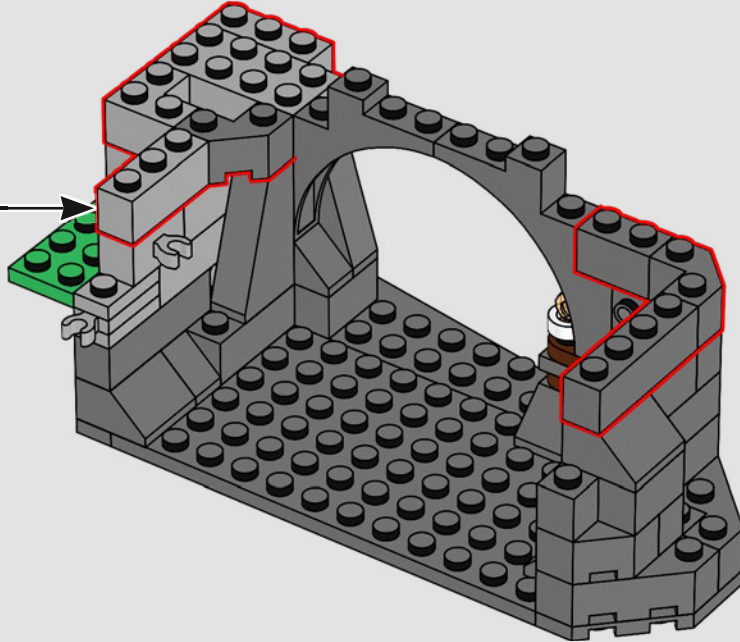
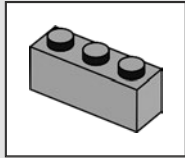

62

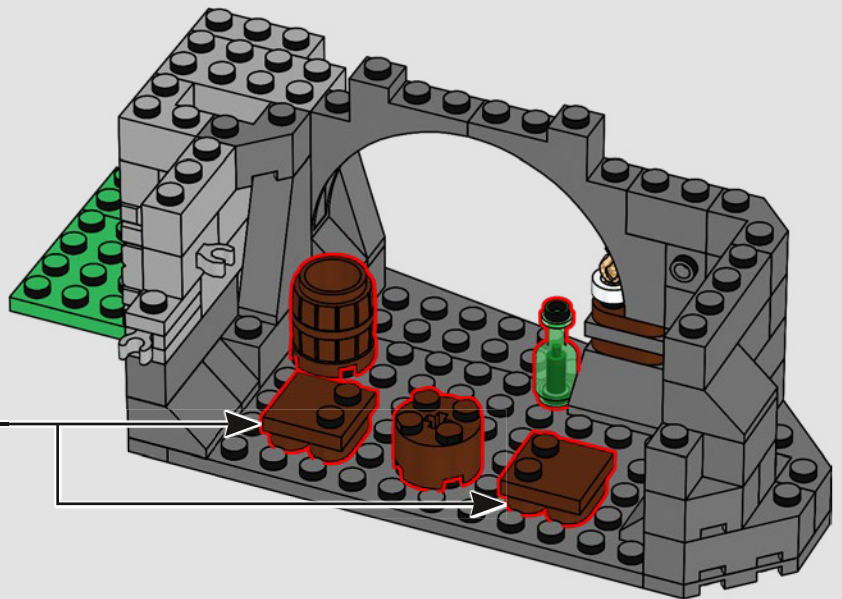
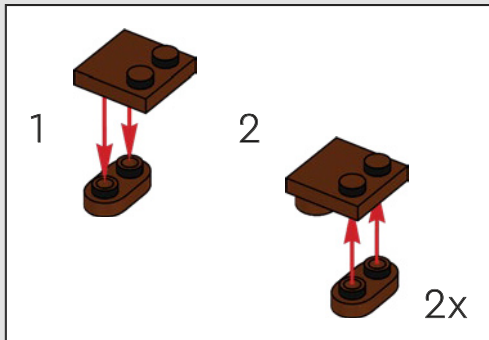



Un arquero podría practicar mucho con este blanco.

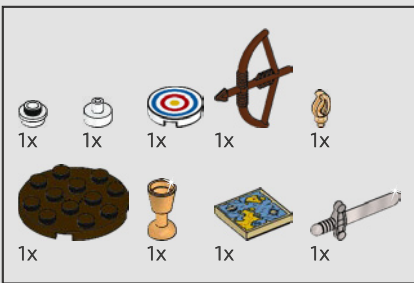

63

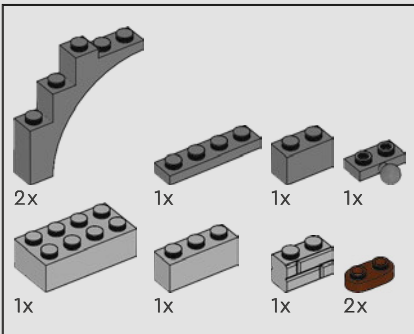
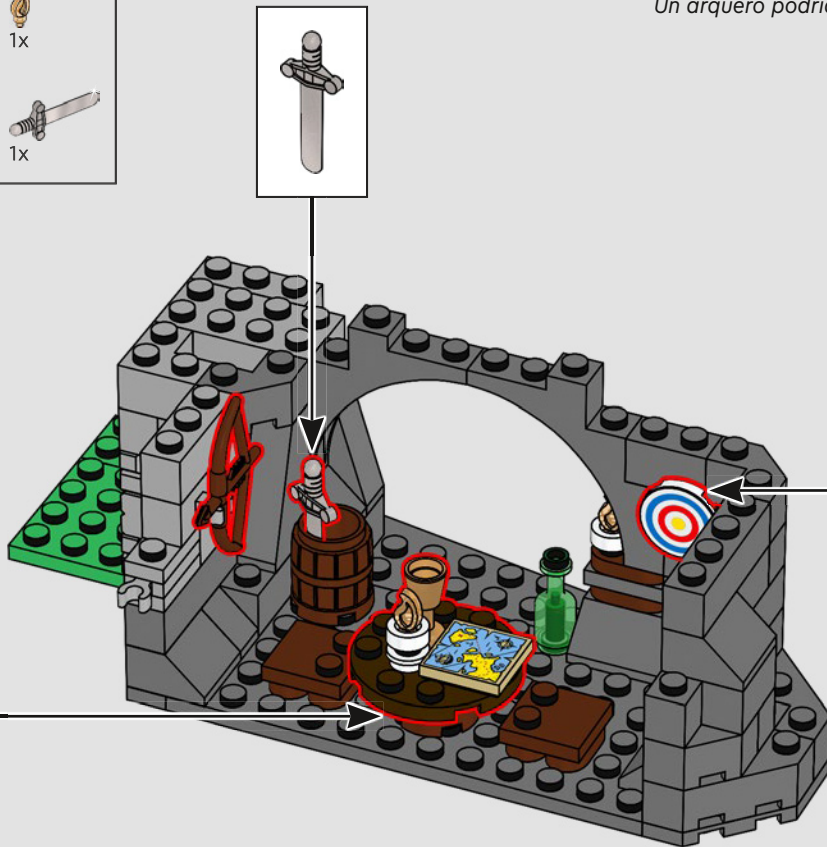
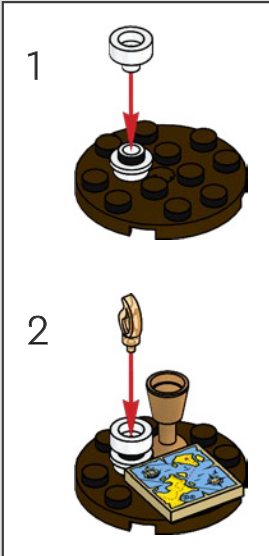

64

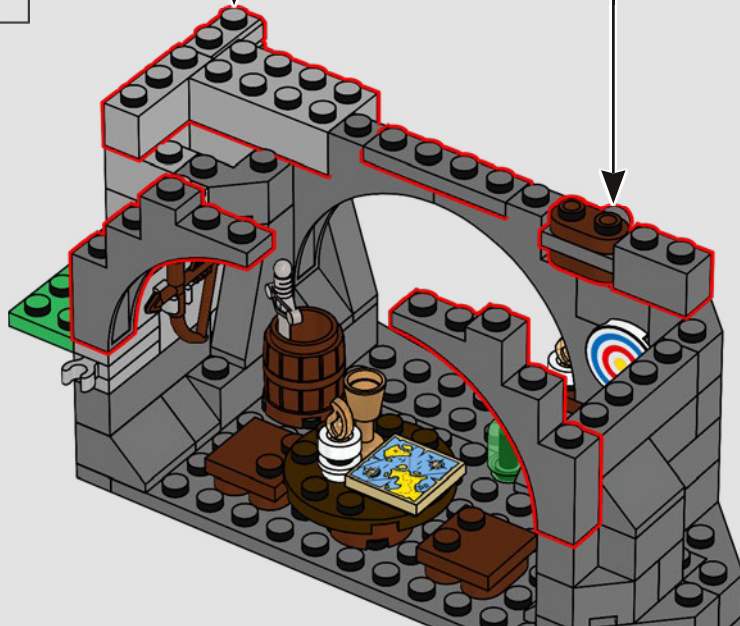
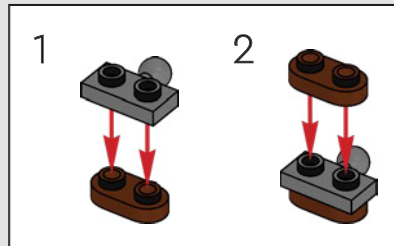
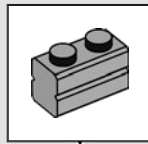

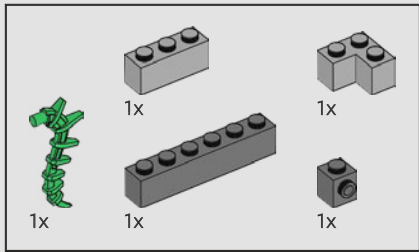

65

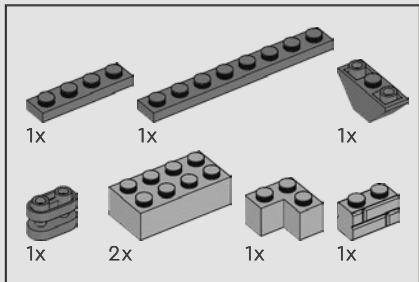
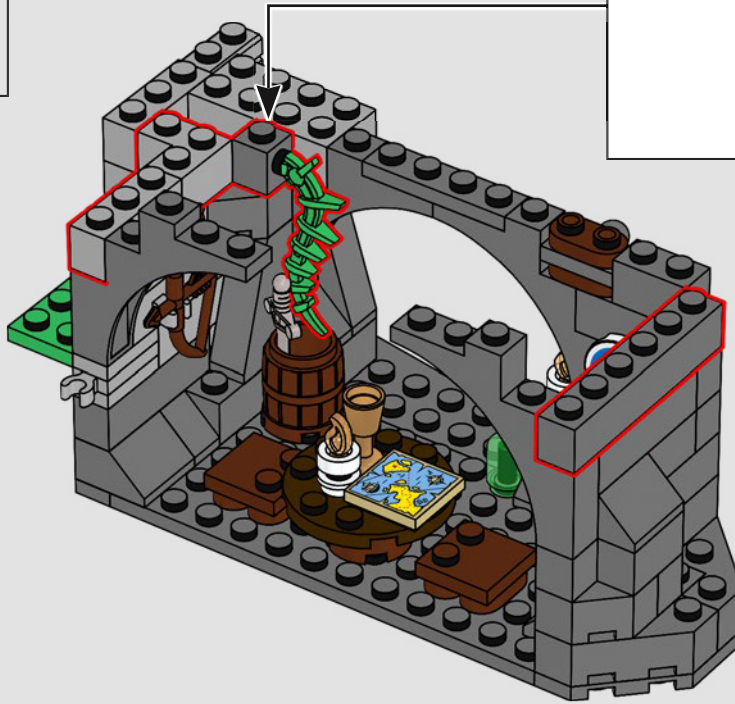
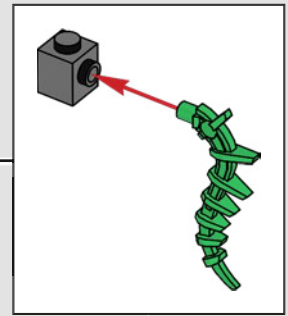

66

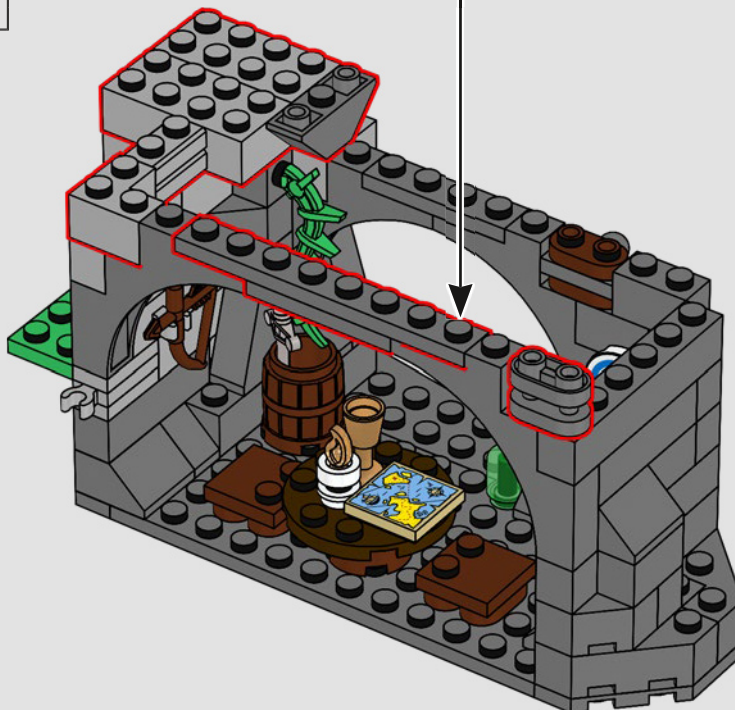
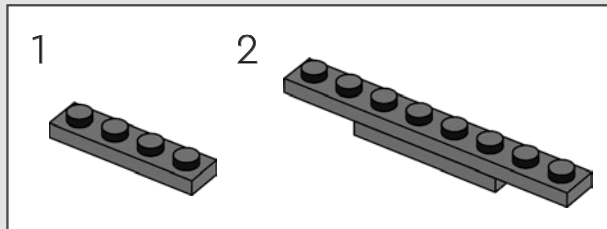

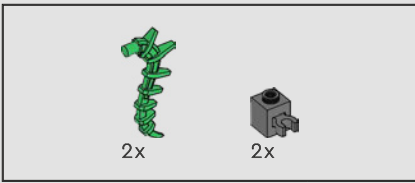

67

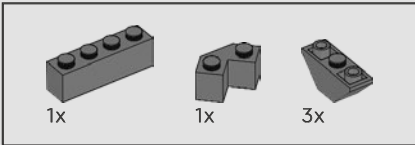
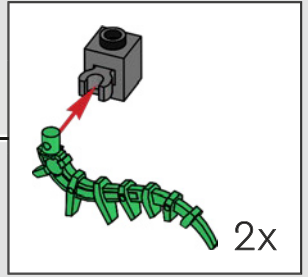
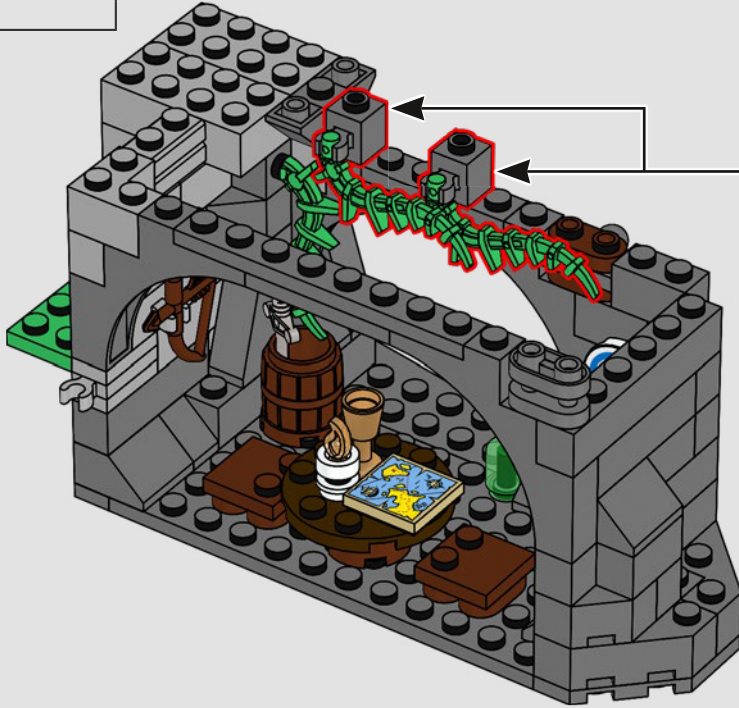

68

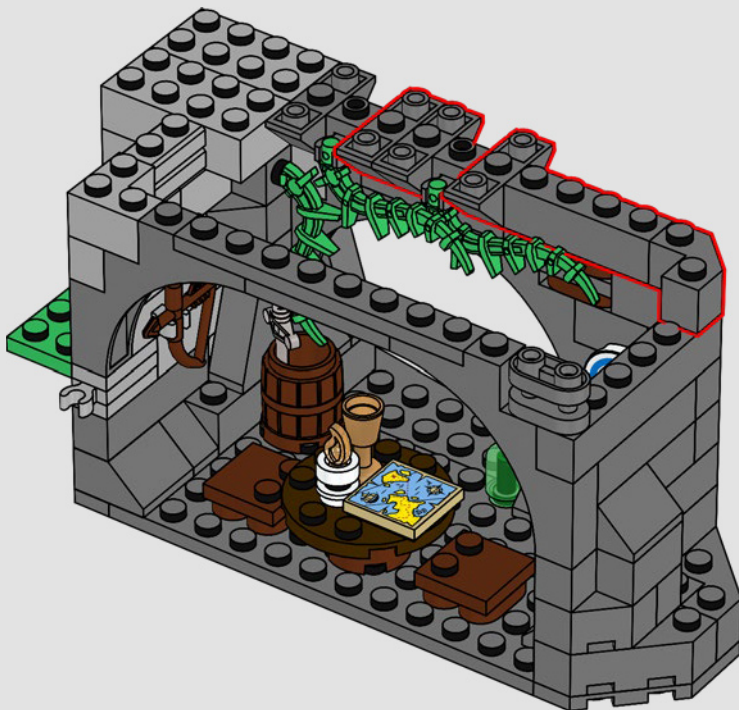

Qué mapa tan peculiar. ¿Qué será todo ese color azul? No creo que haya mares tan grandes...

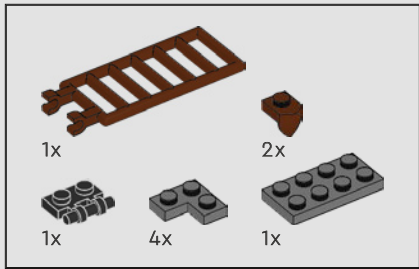

69

1

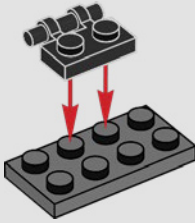

2

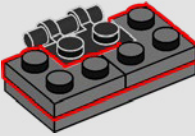

3

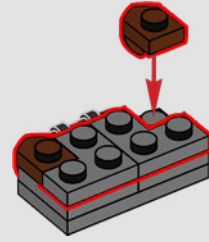

4

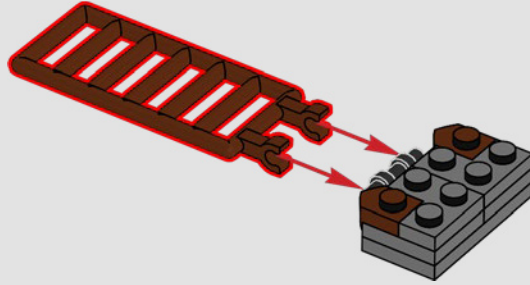

5

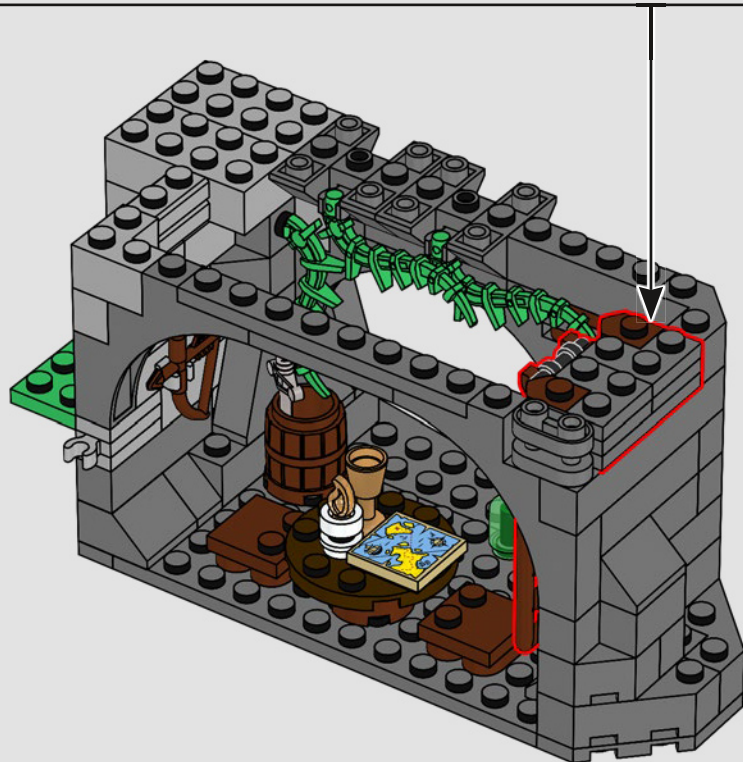
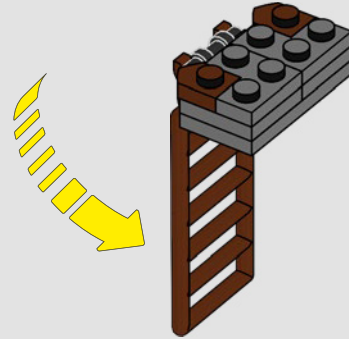

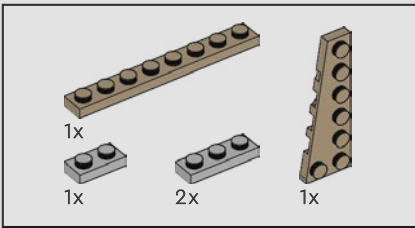

70

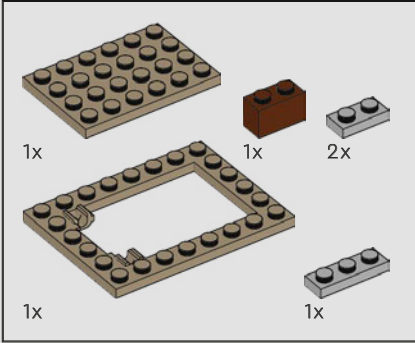
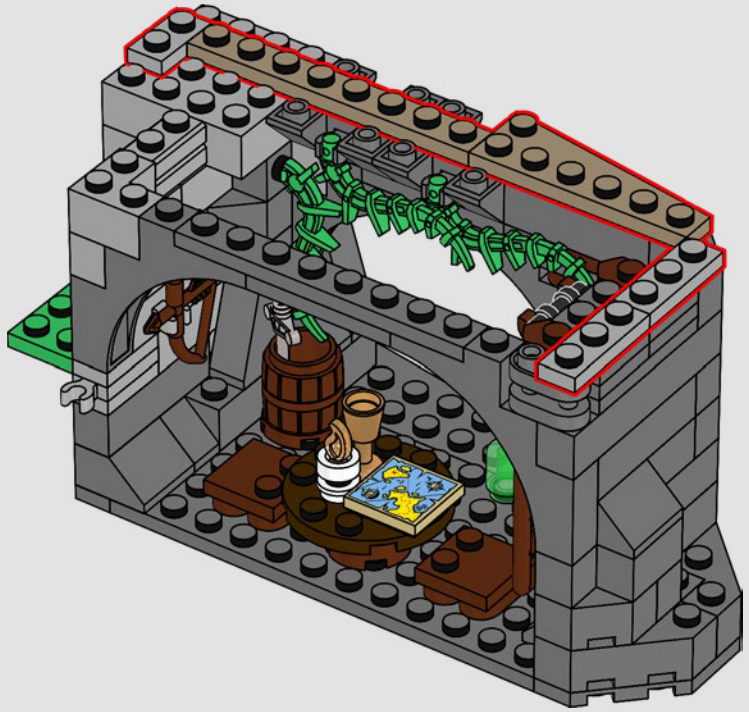

71

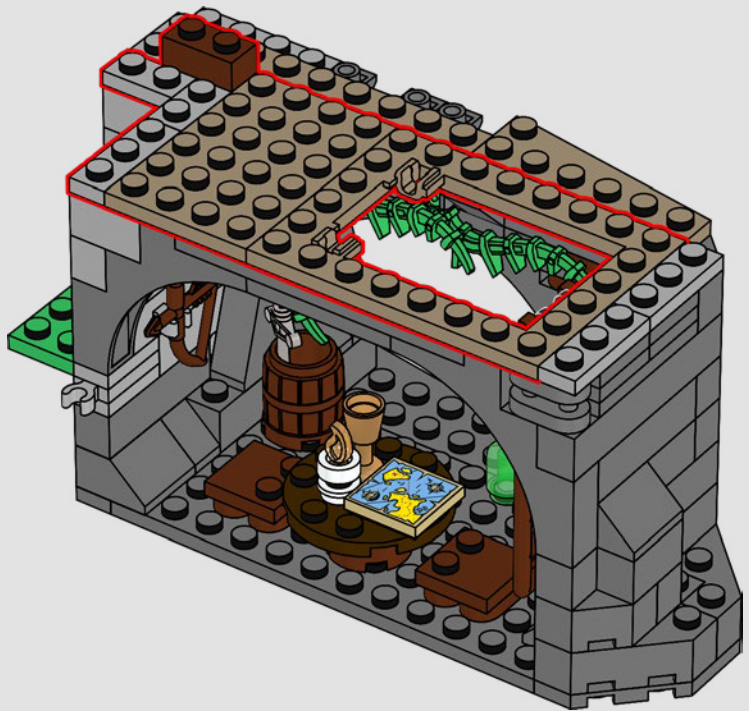

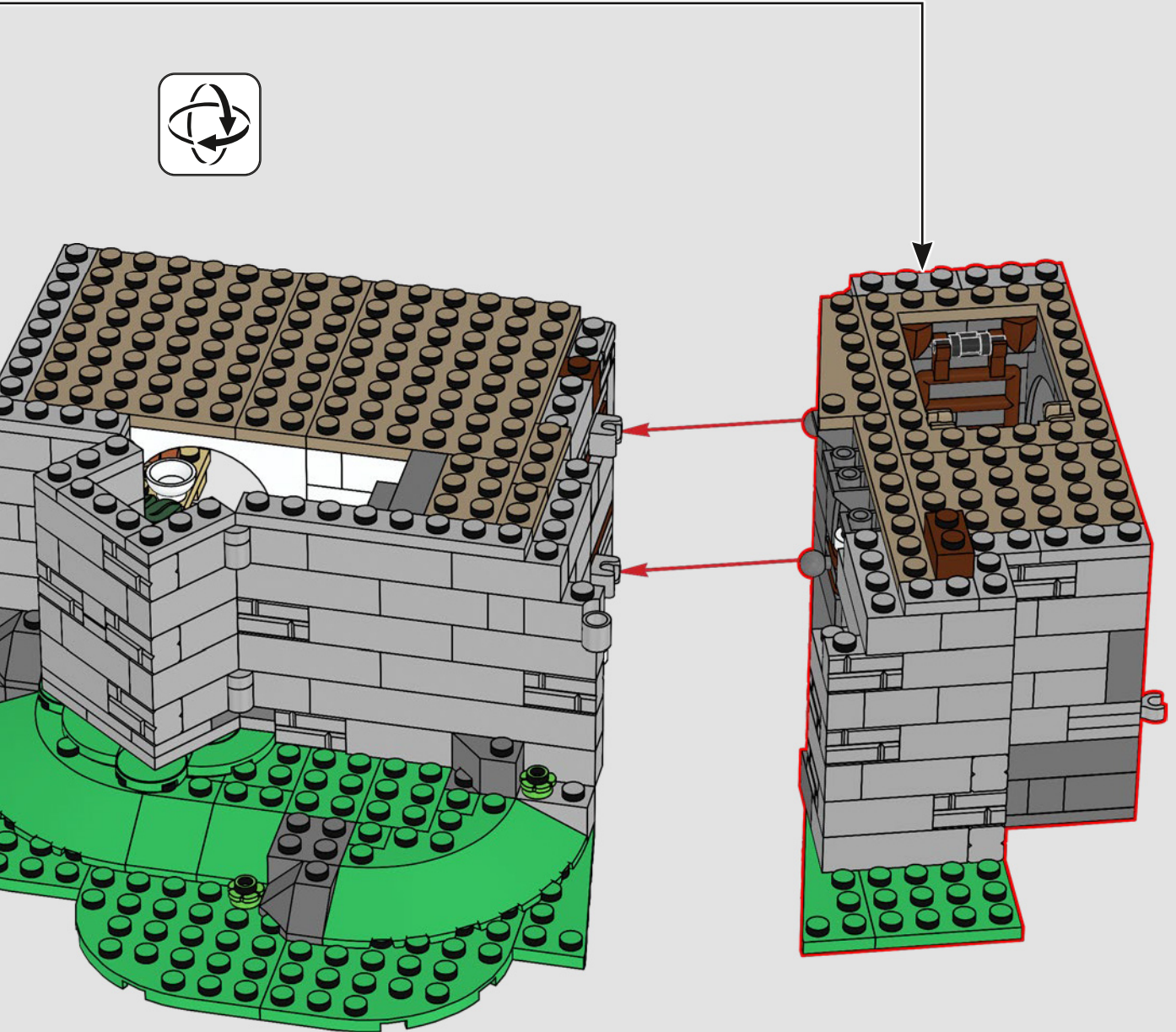

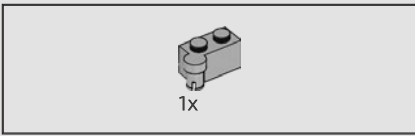

73

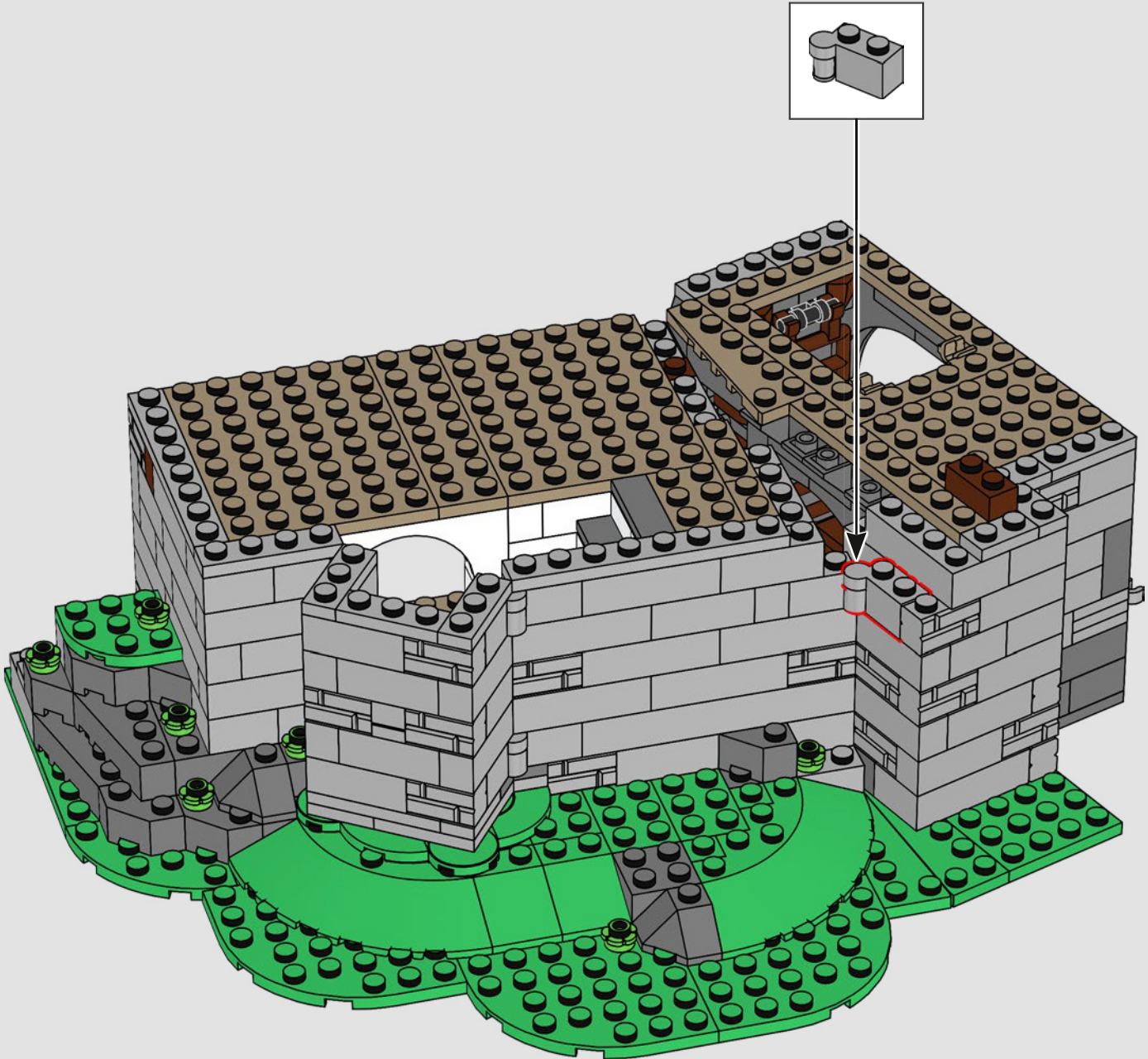

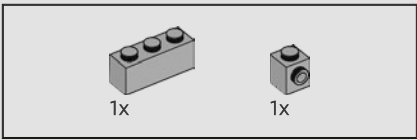

74

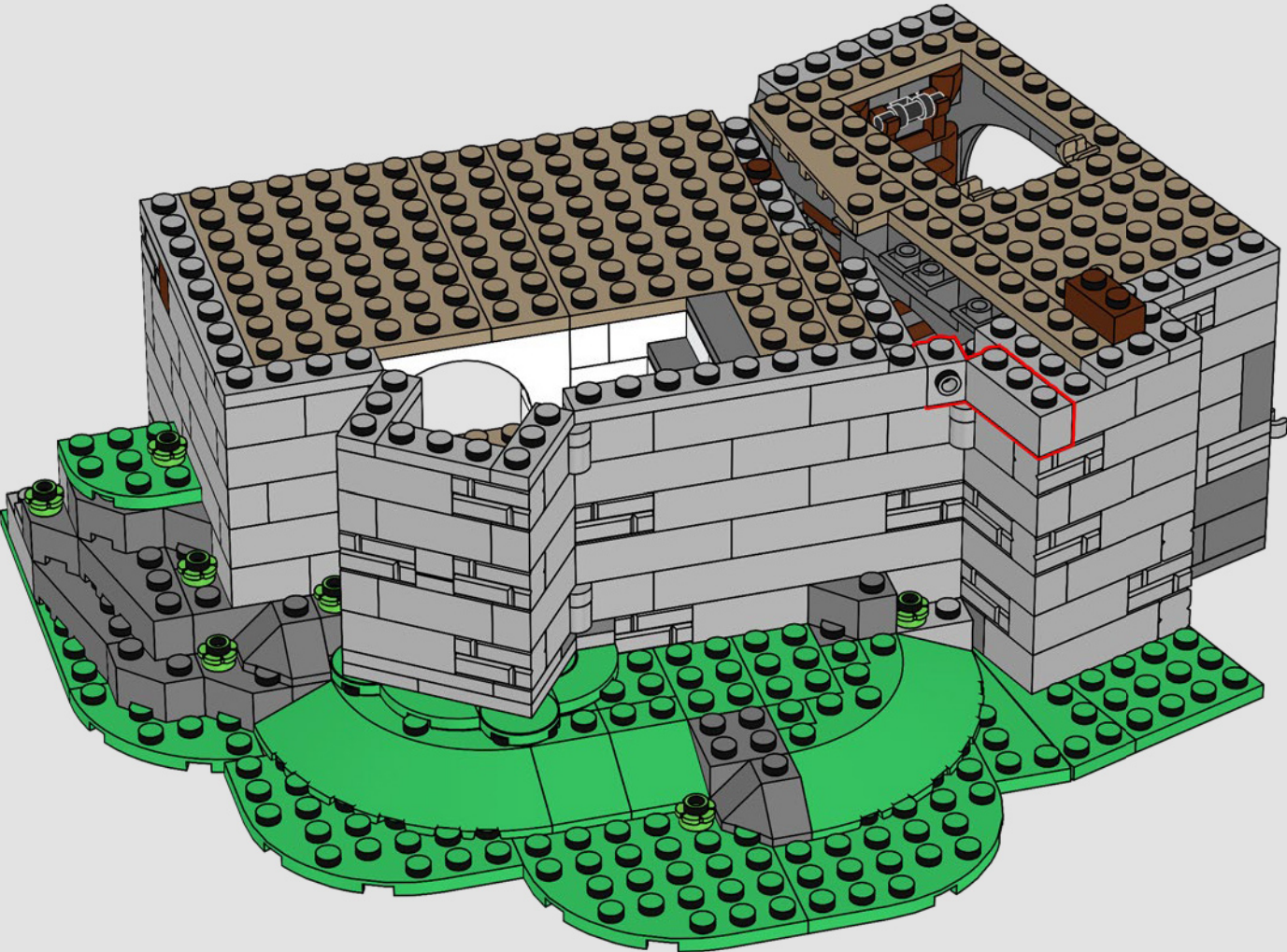

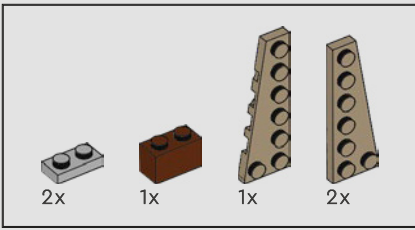

75

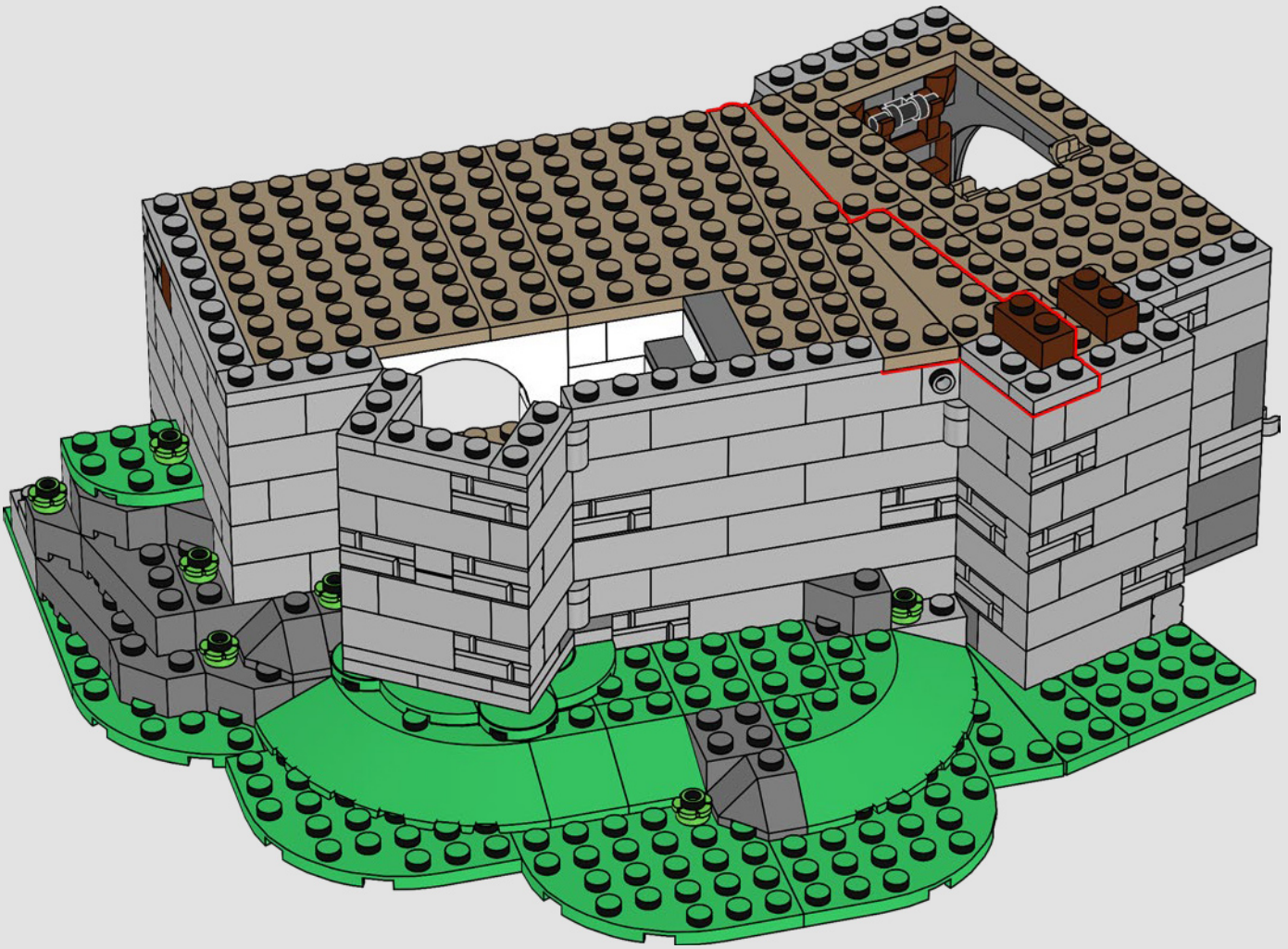

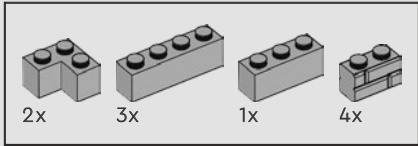

76

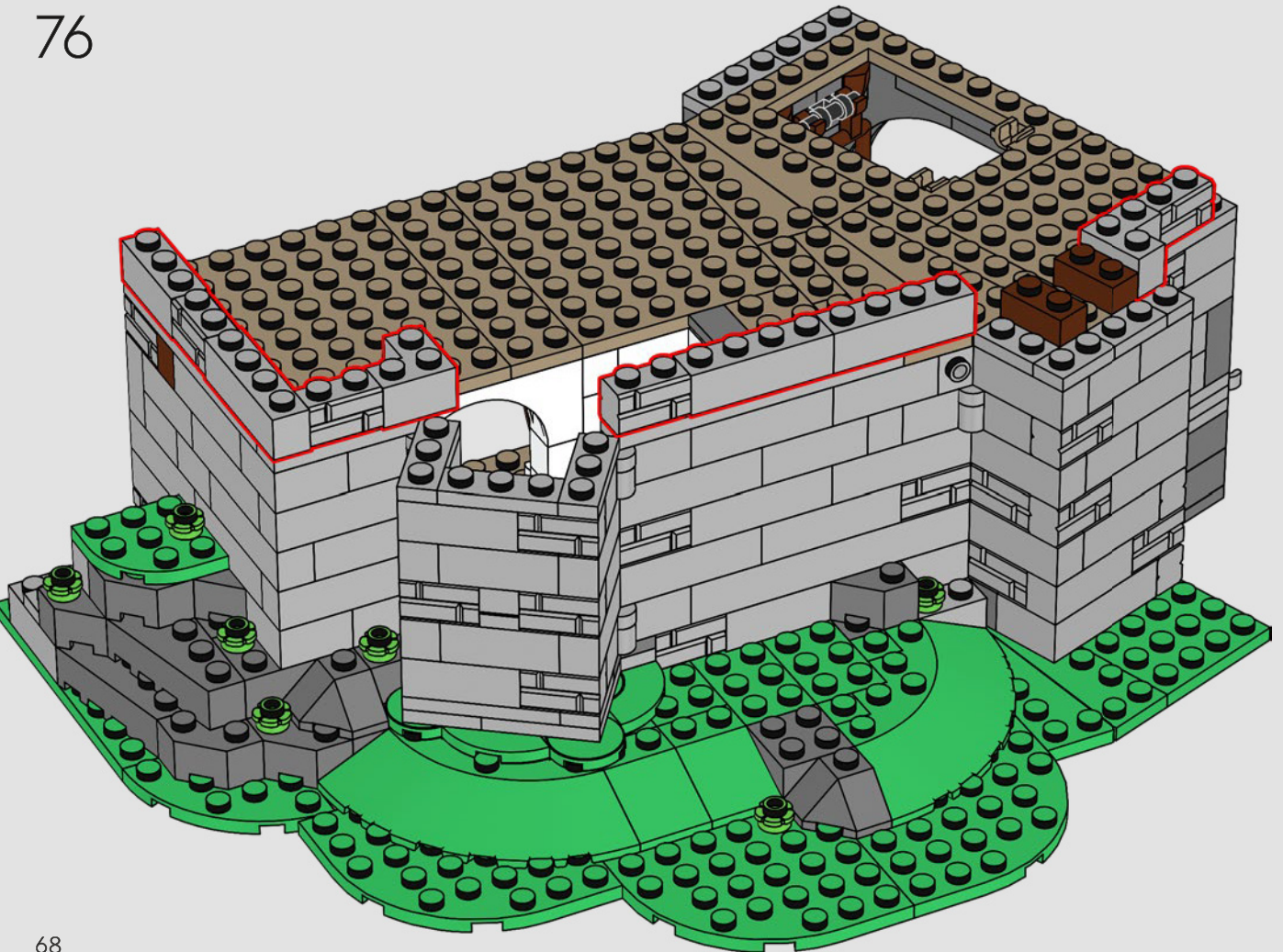

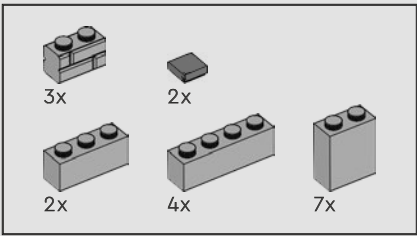

77

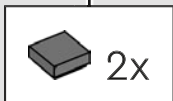
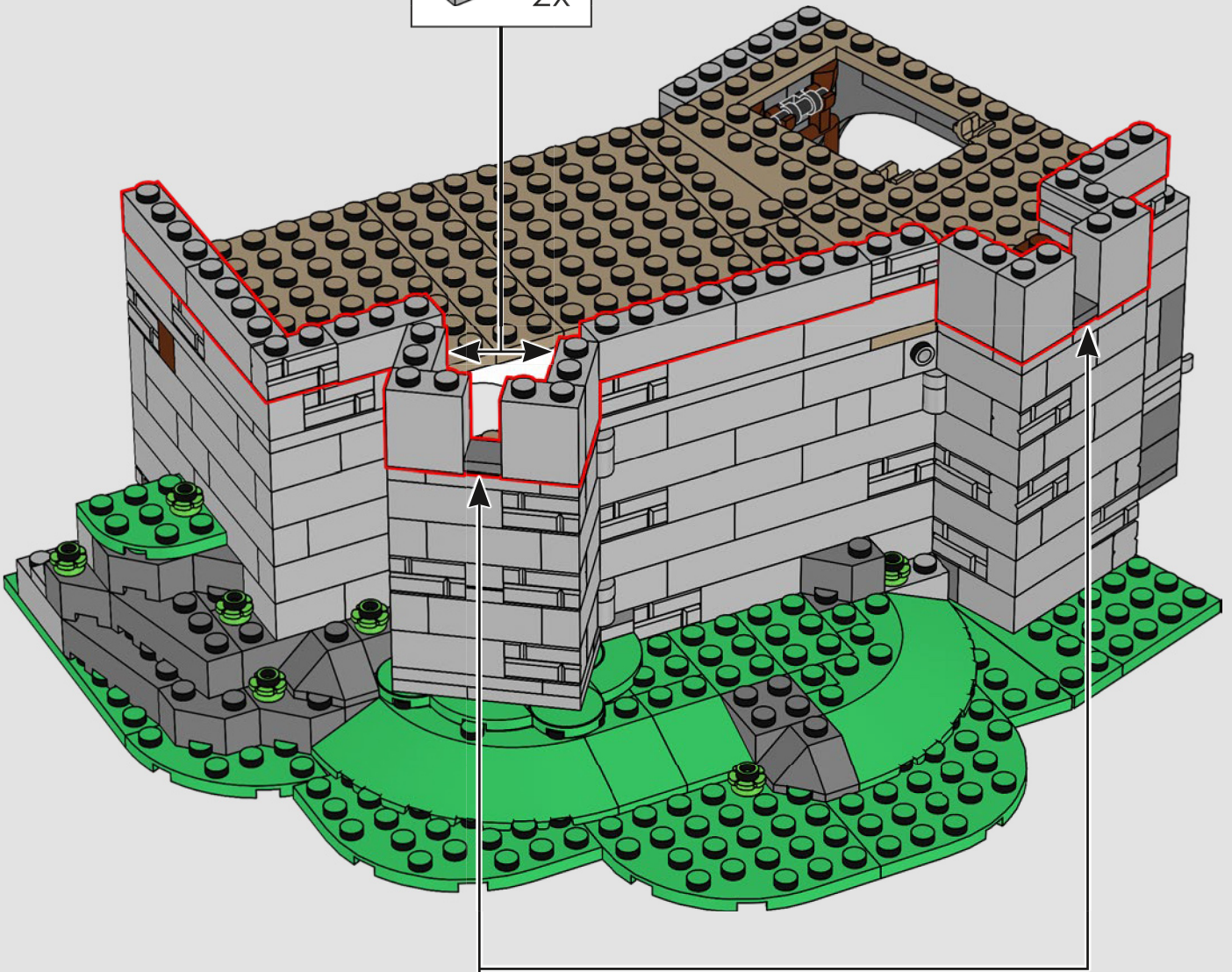
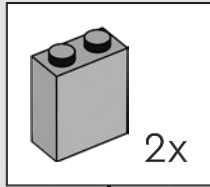

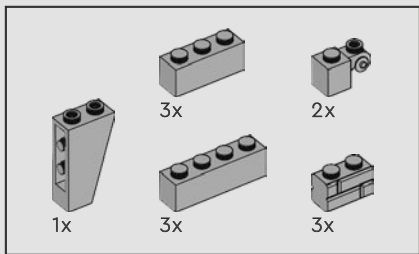

78

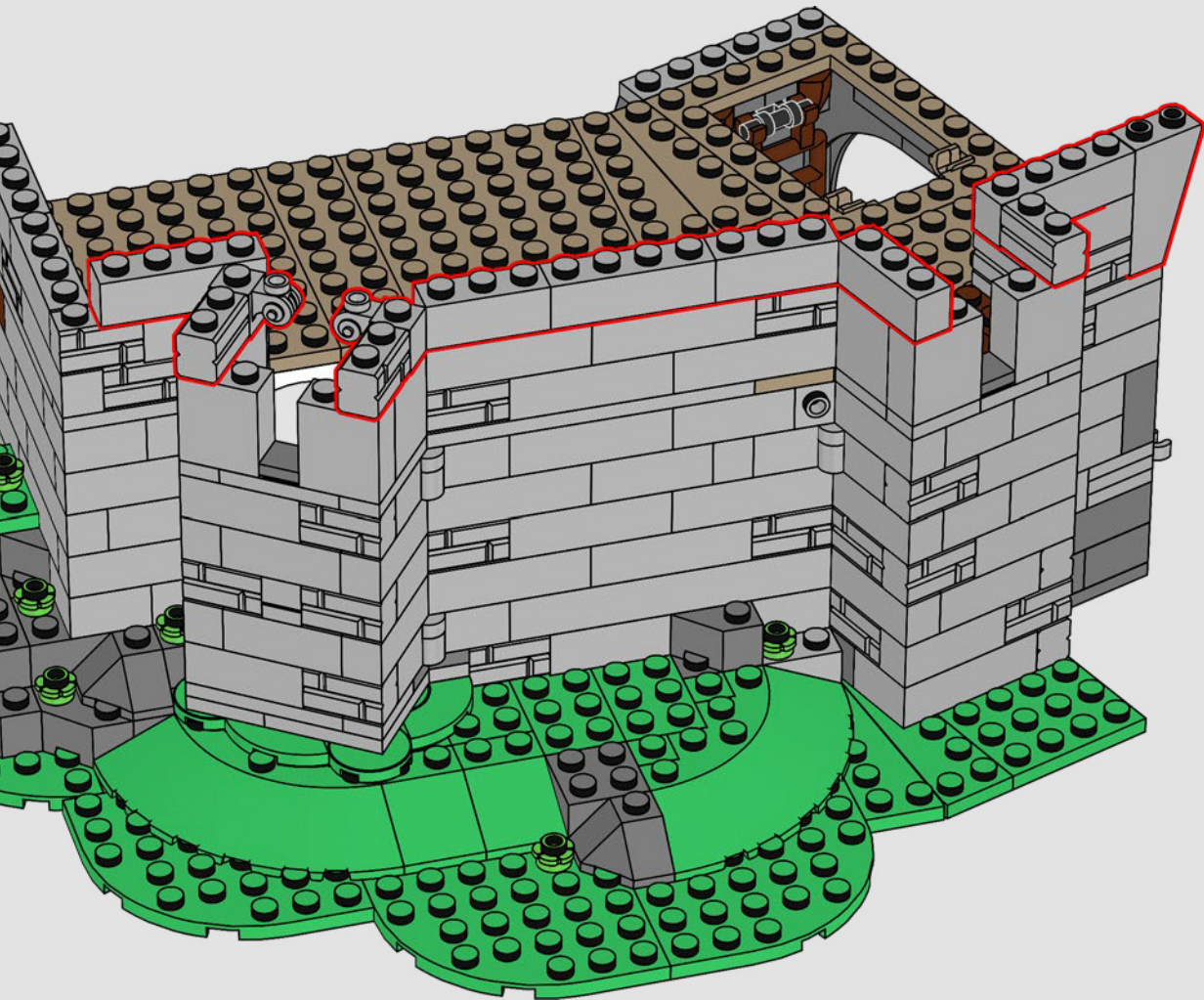

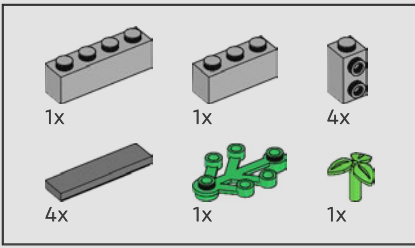

79

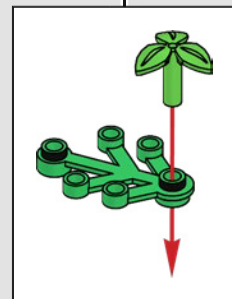
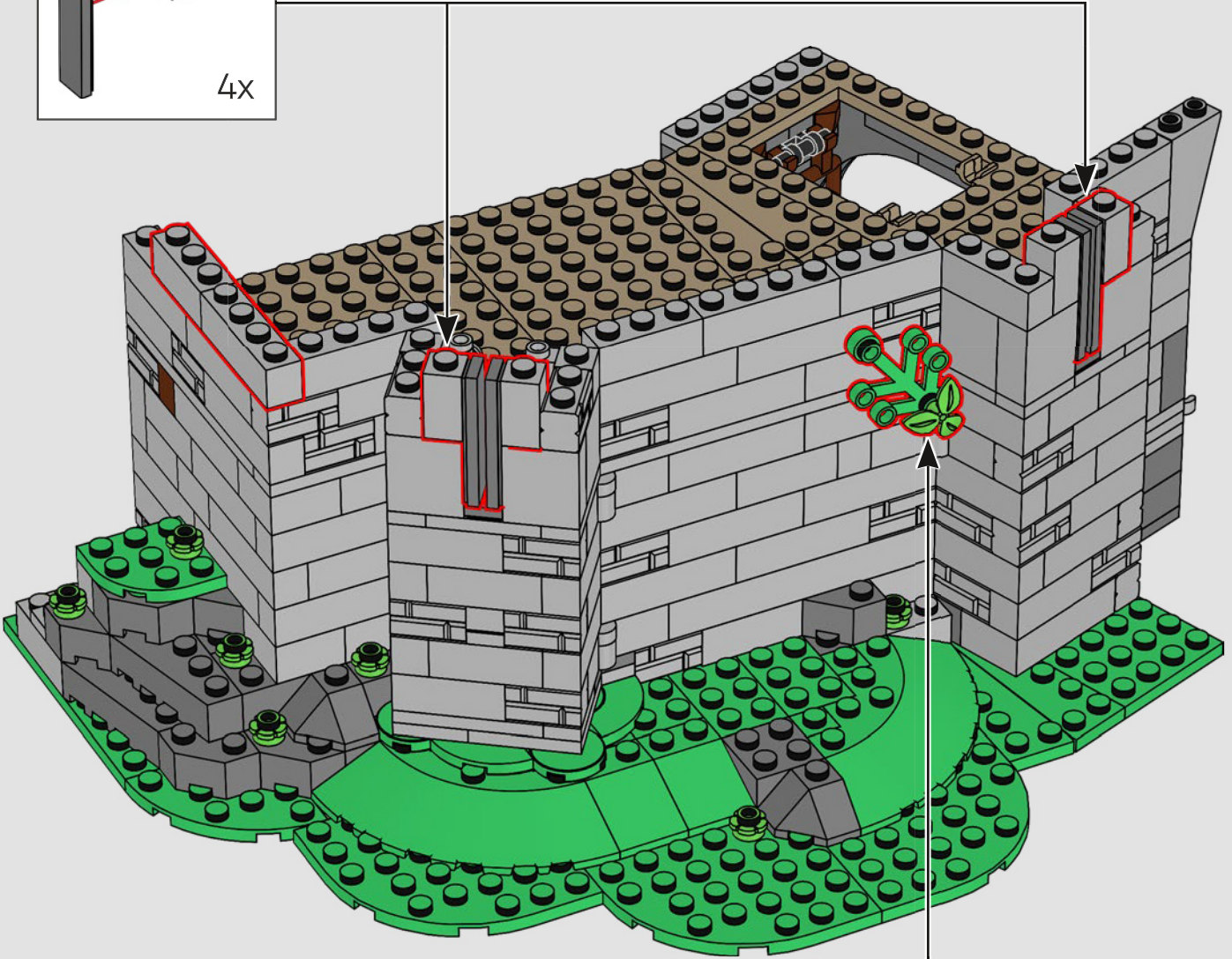
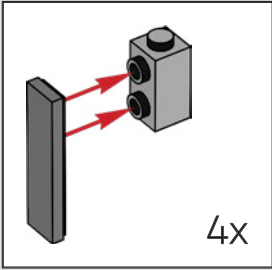

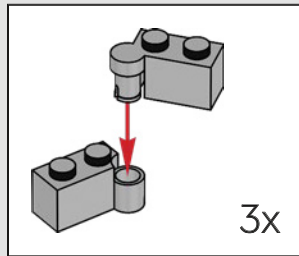
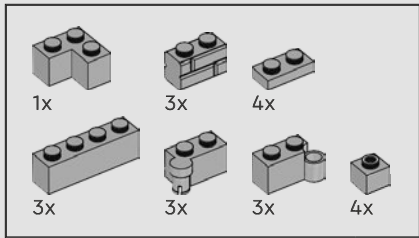

80

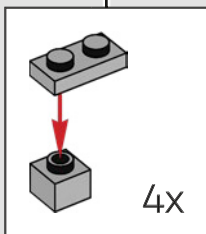

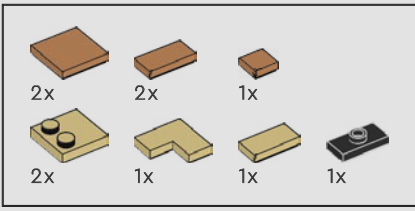

81



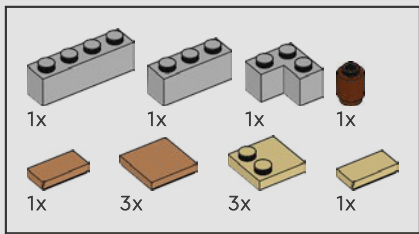

82

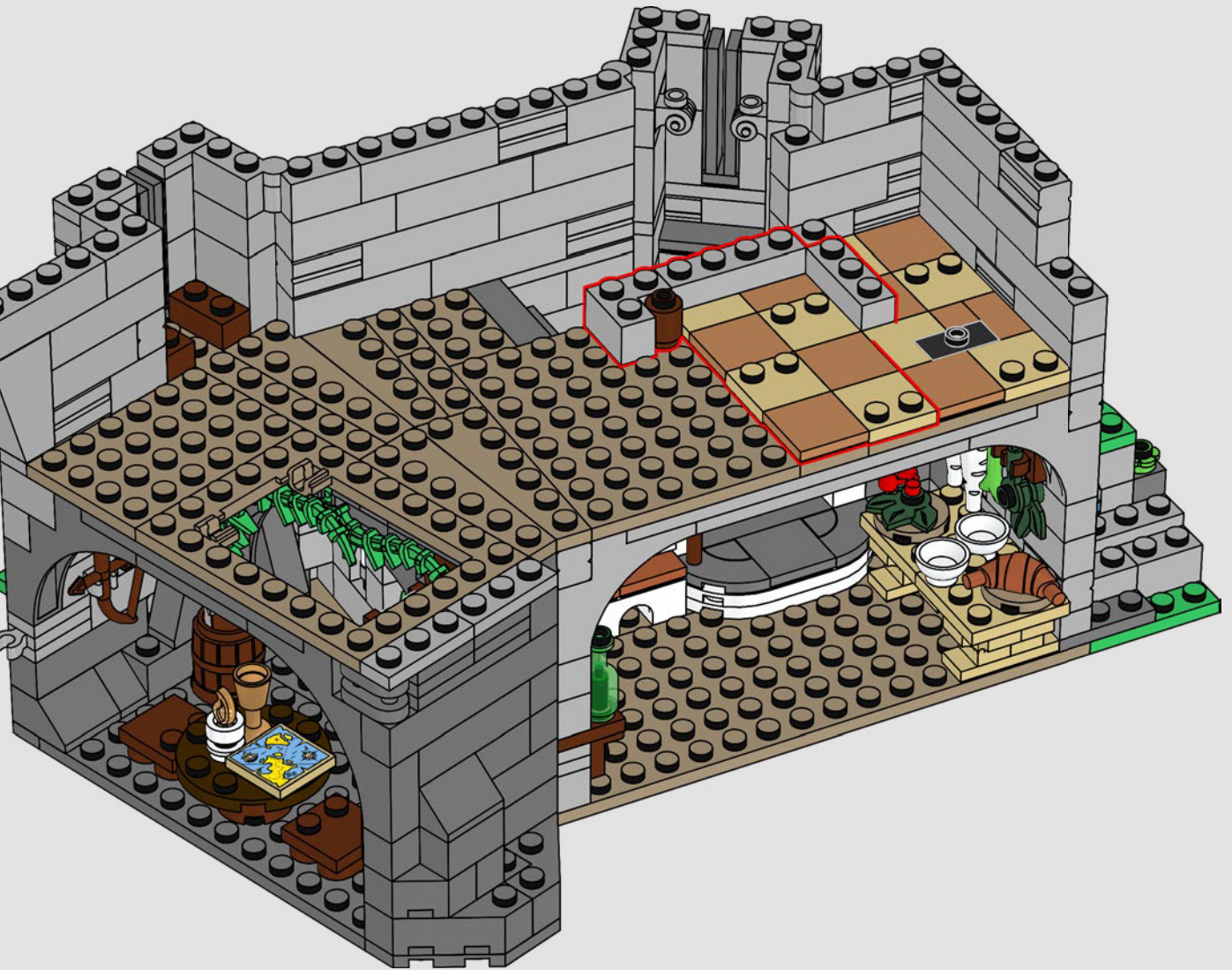

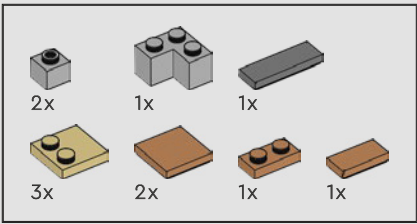

83

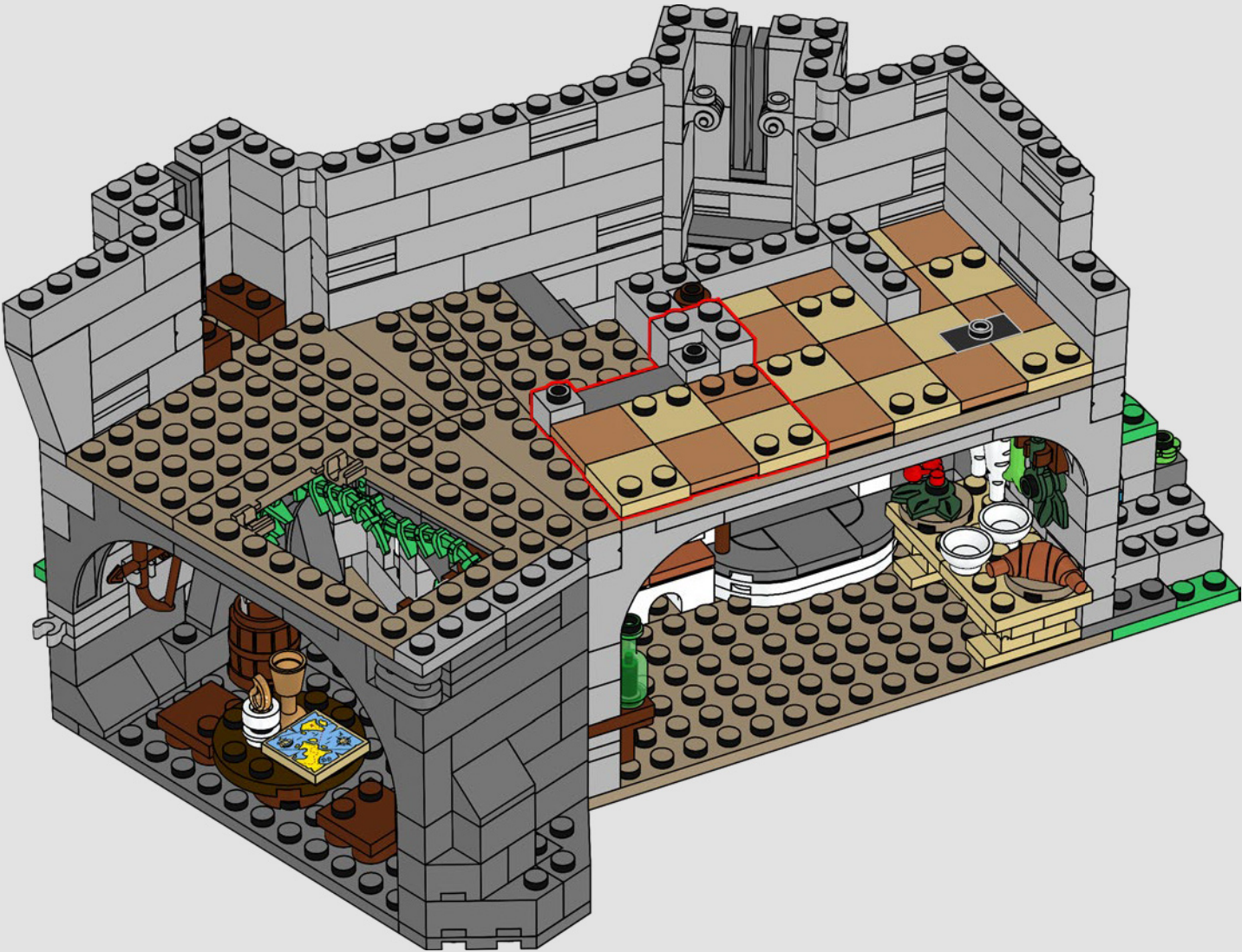



*¿Por qué está cubierta esta entrada?
¿Acaso pretendéis que vuestros
aposentos permanezcan ocultos a la
señora del castillo?*

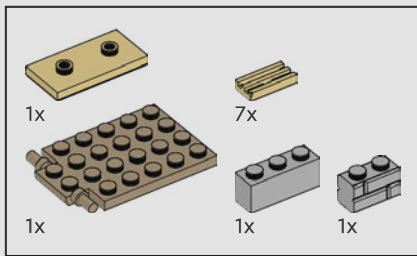

84

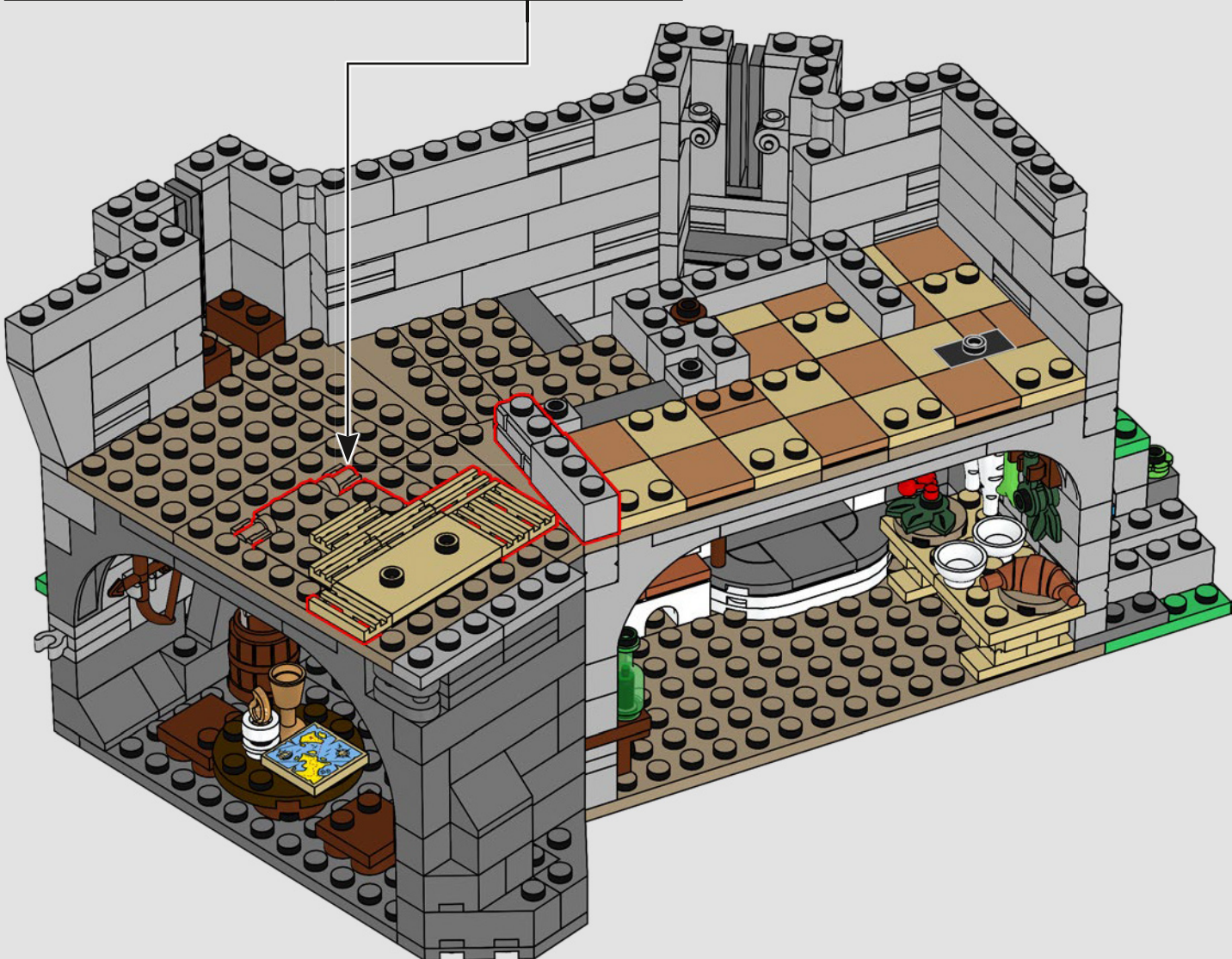
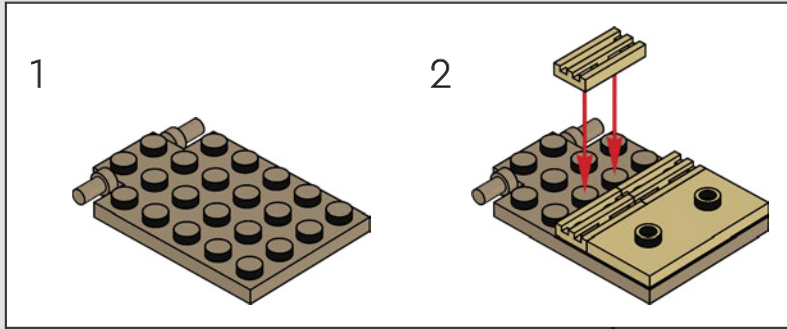

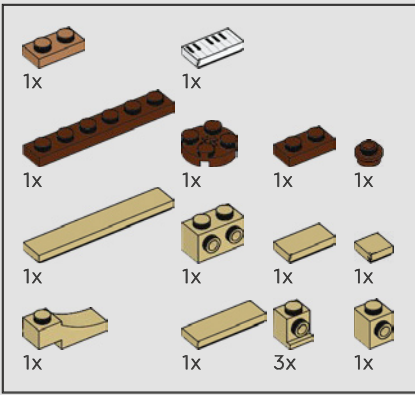

85

1

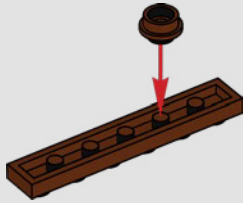

2

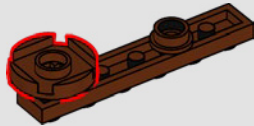

3

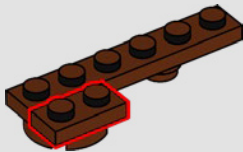

4

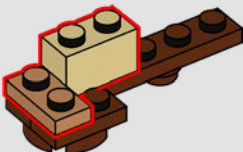

5

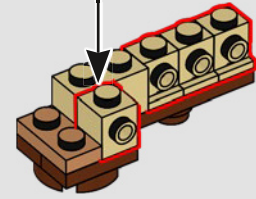
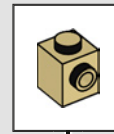

6

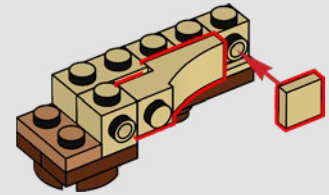

7

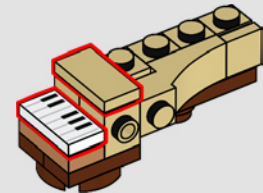

8

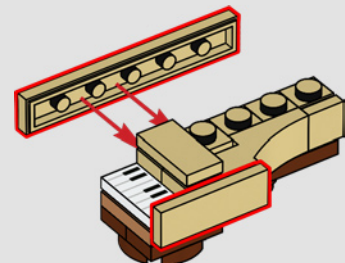



*Diantres..., ¿es ese el melodioso
sonido de un clavecín? ¡Toda
una maravilla musical de la
modernidad!*

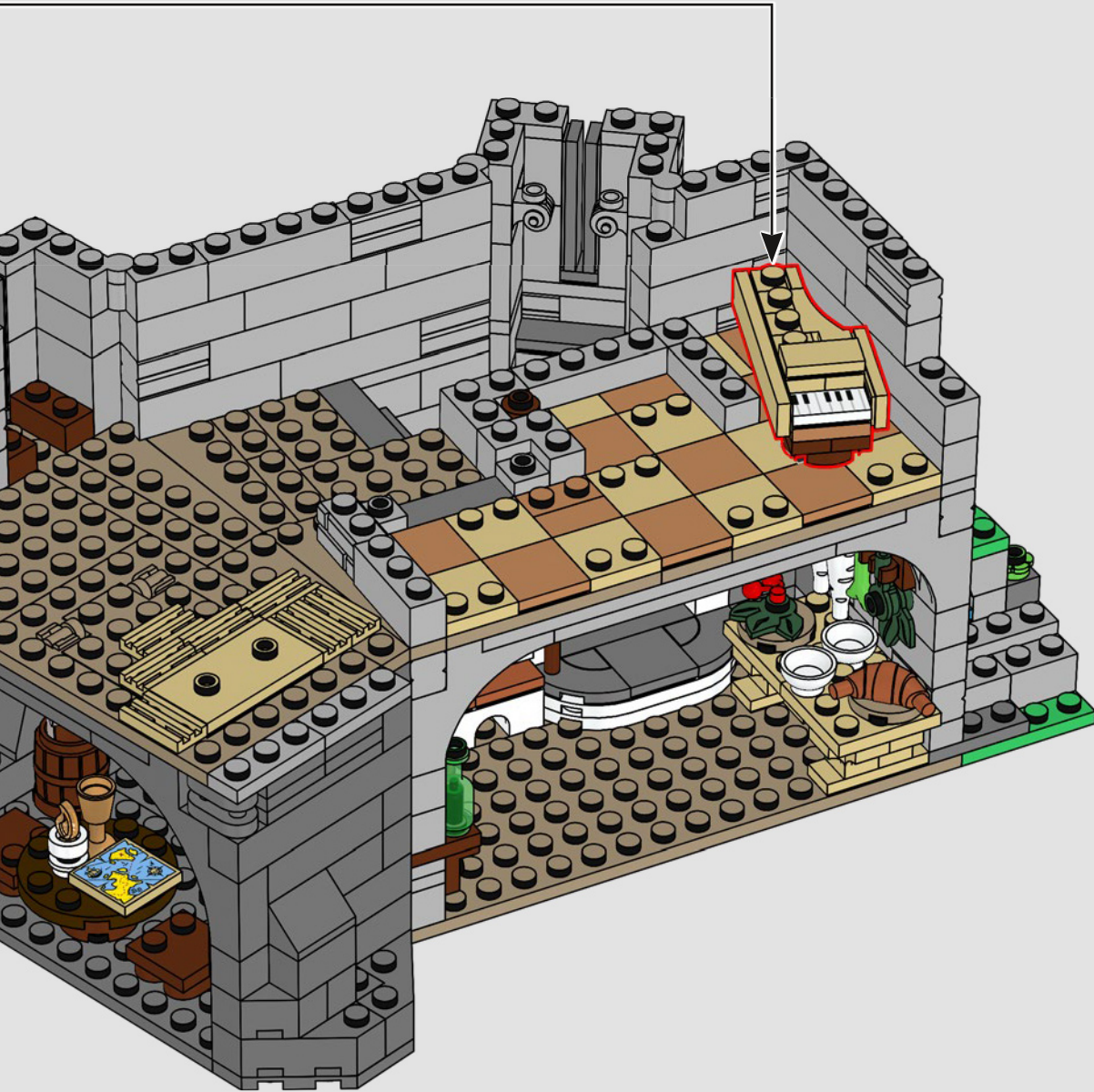

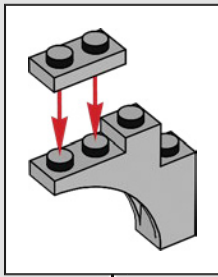
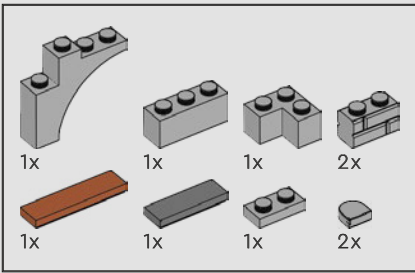

86

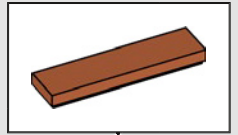
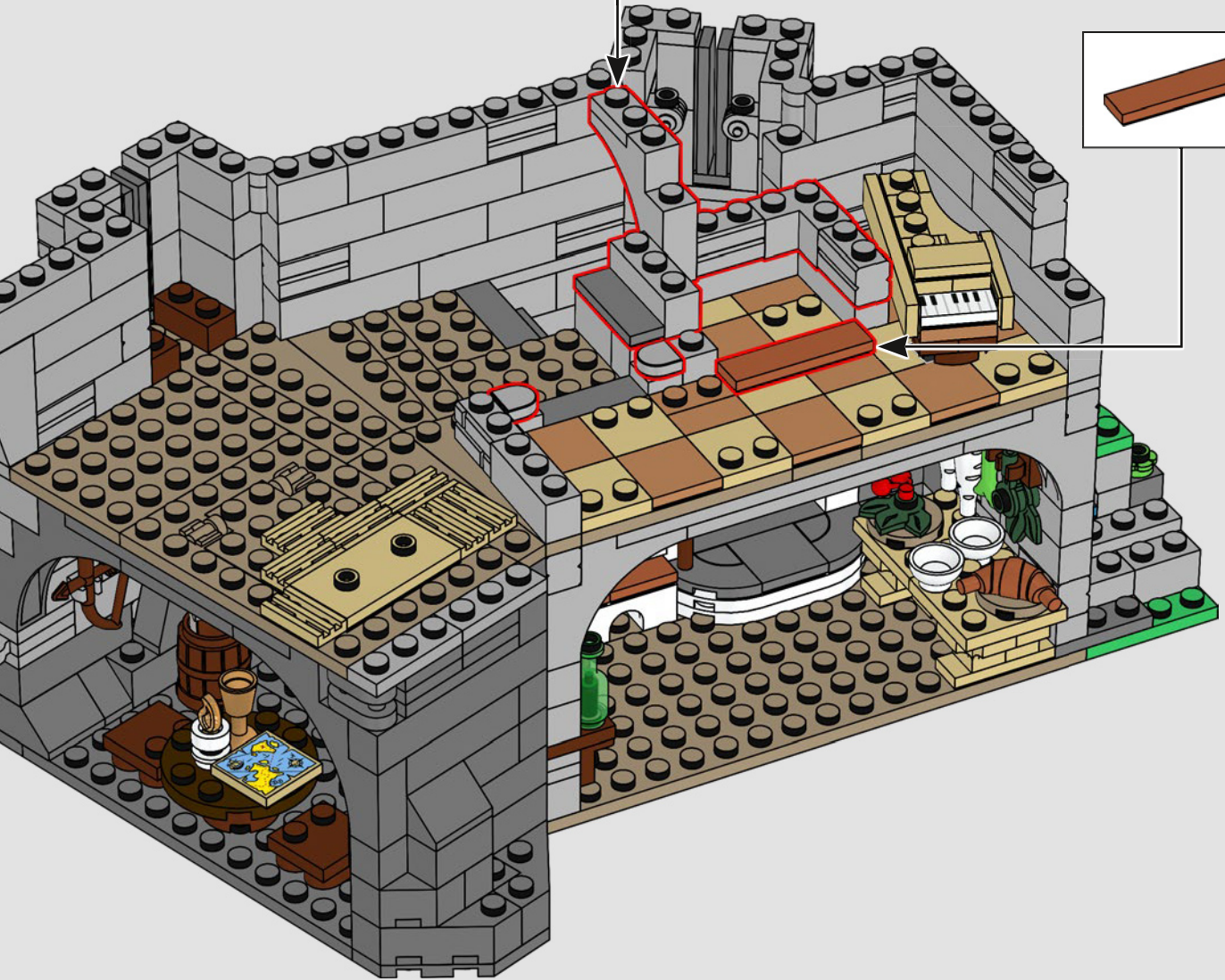

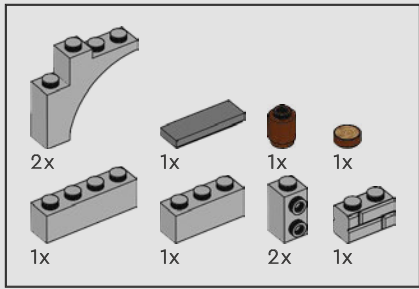

87

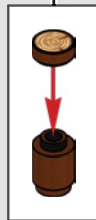
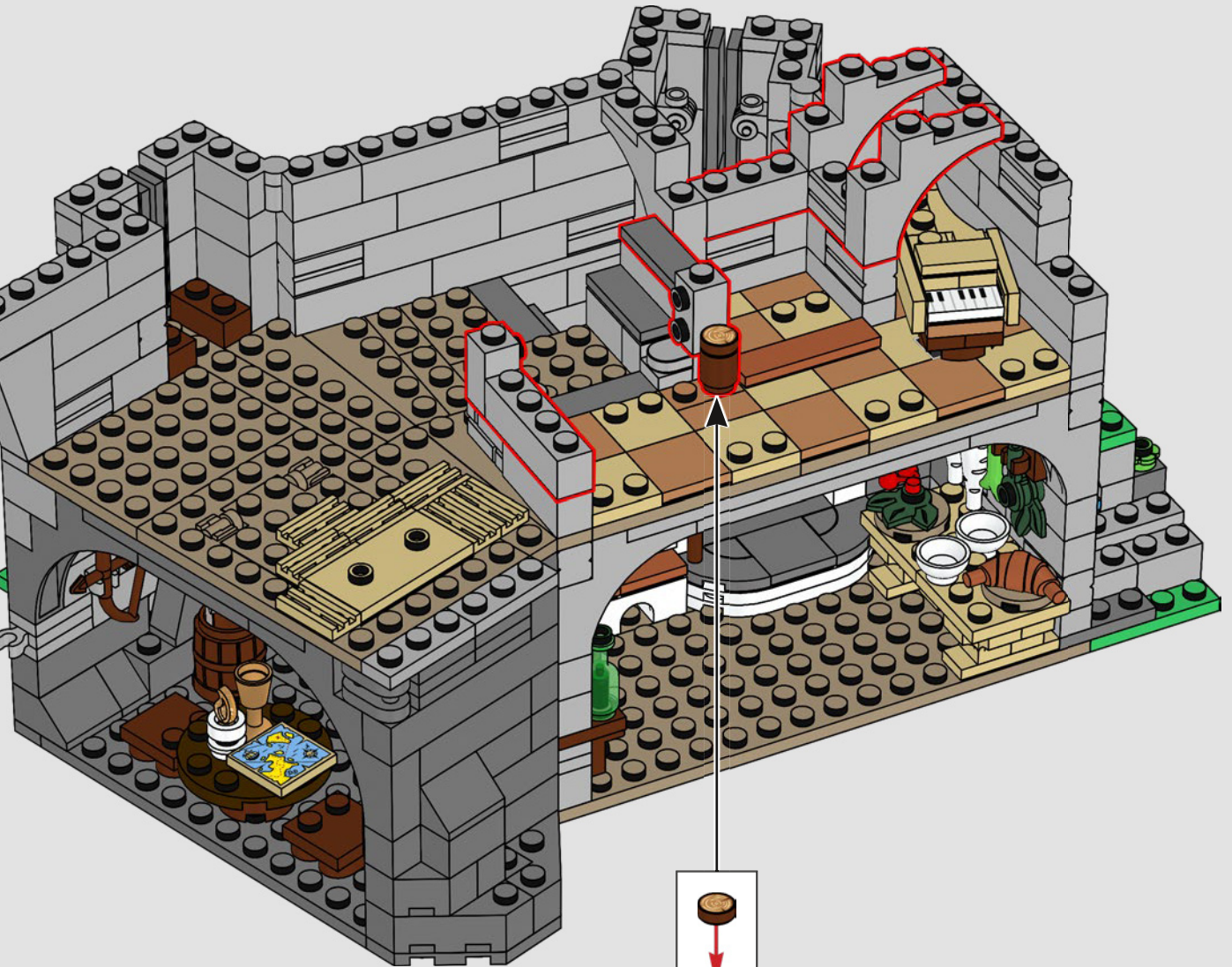

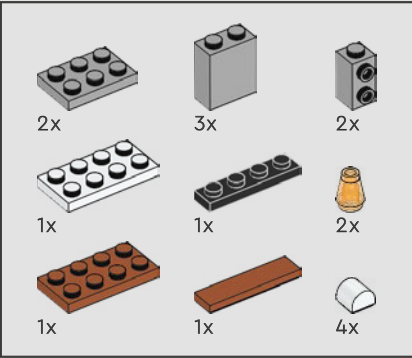
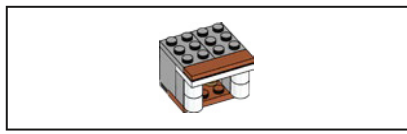

88

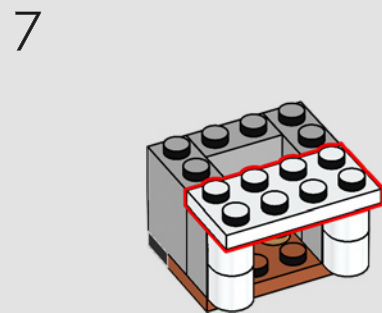
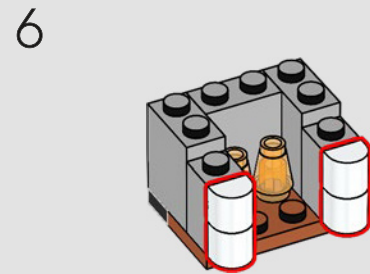
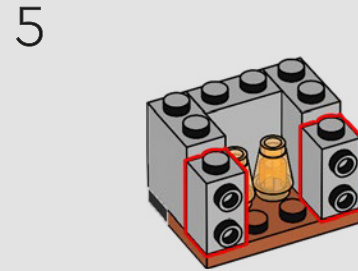
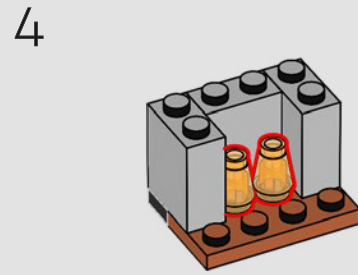
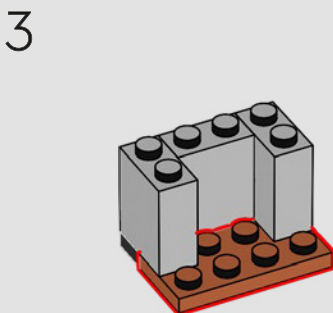
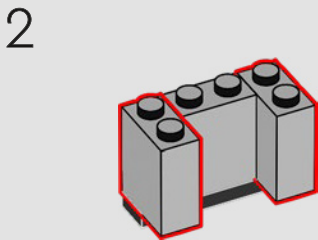
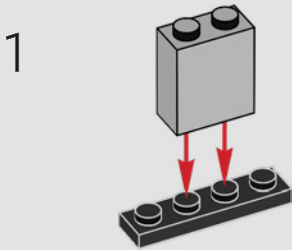

8

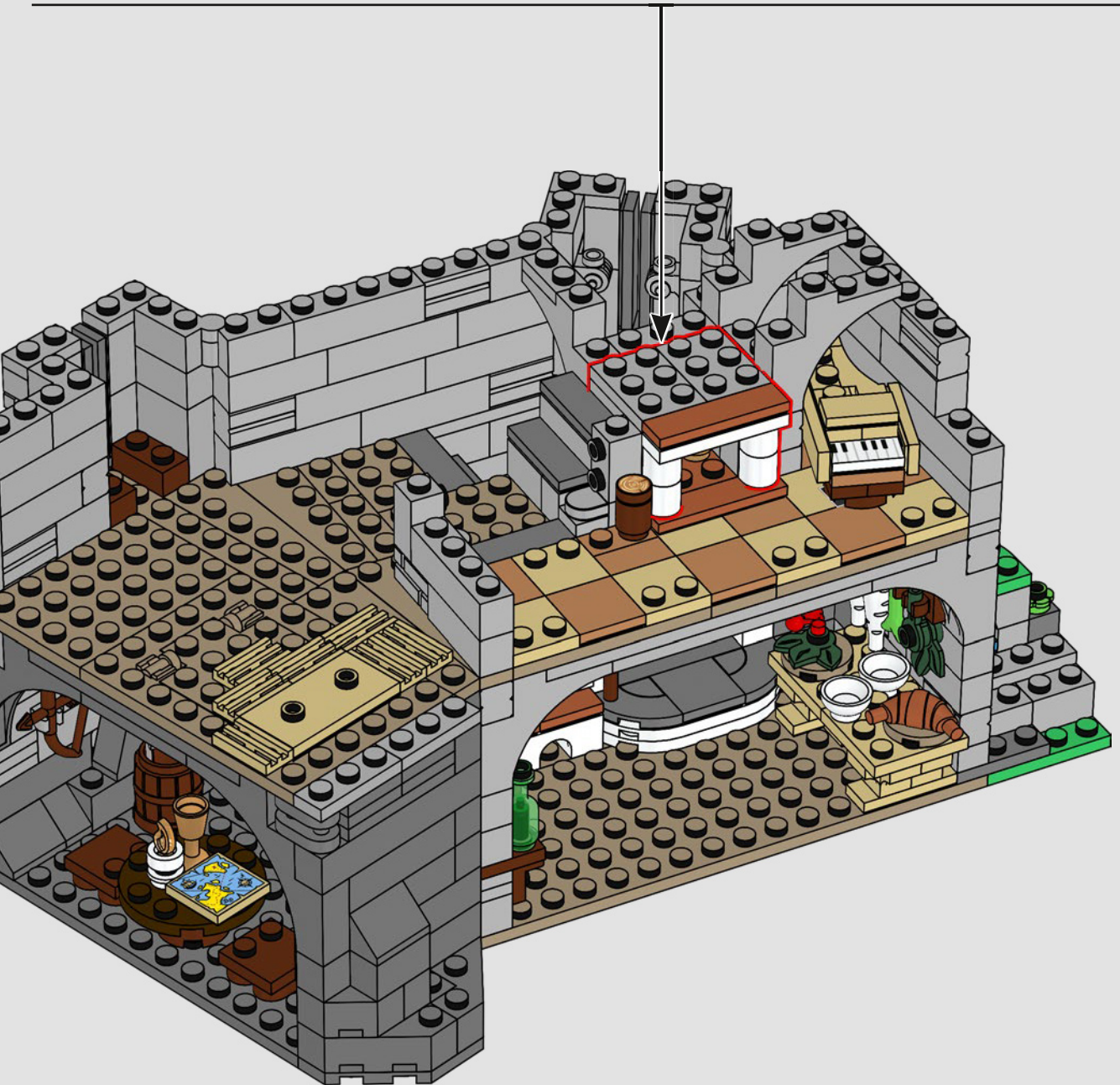
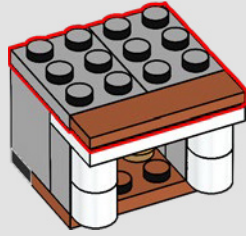

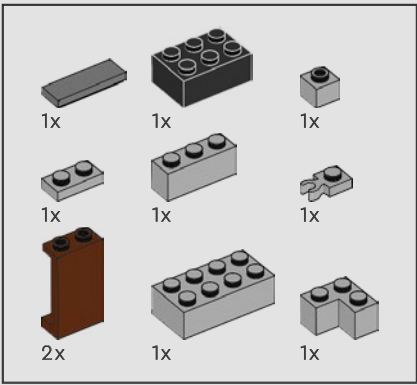

89

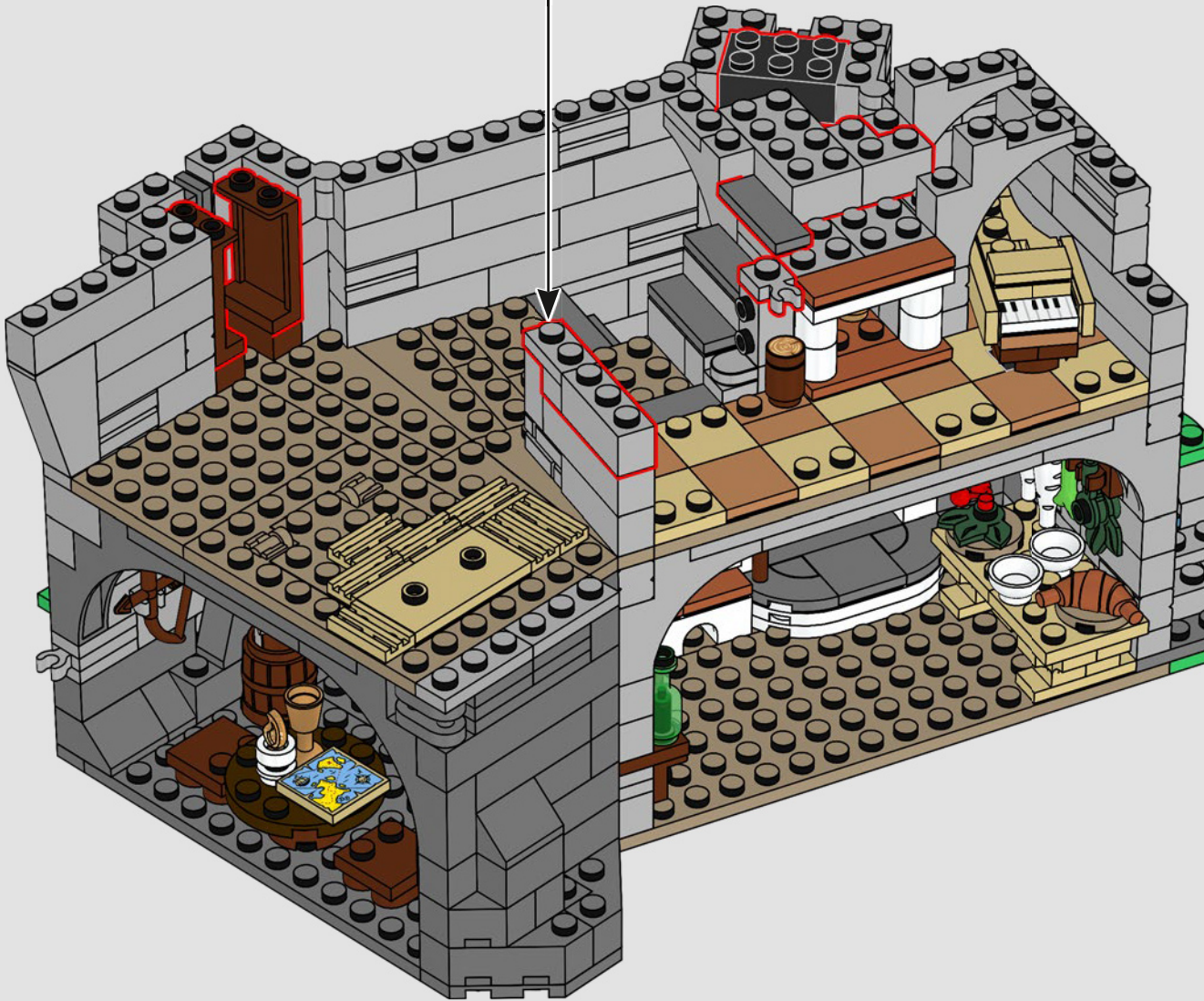
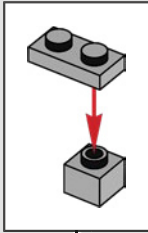

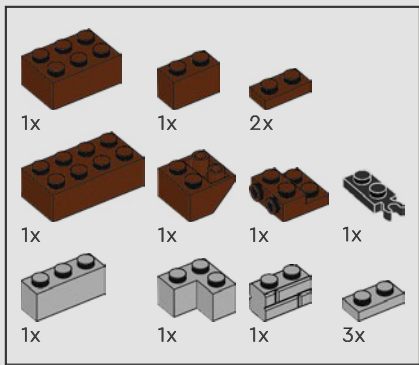

90

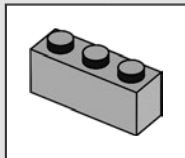
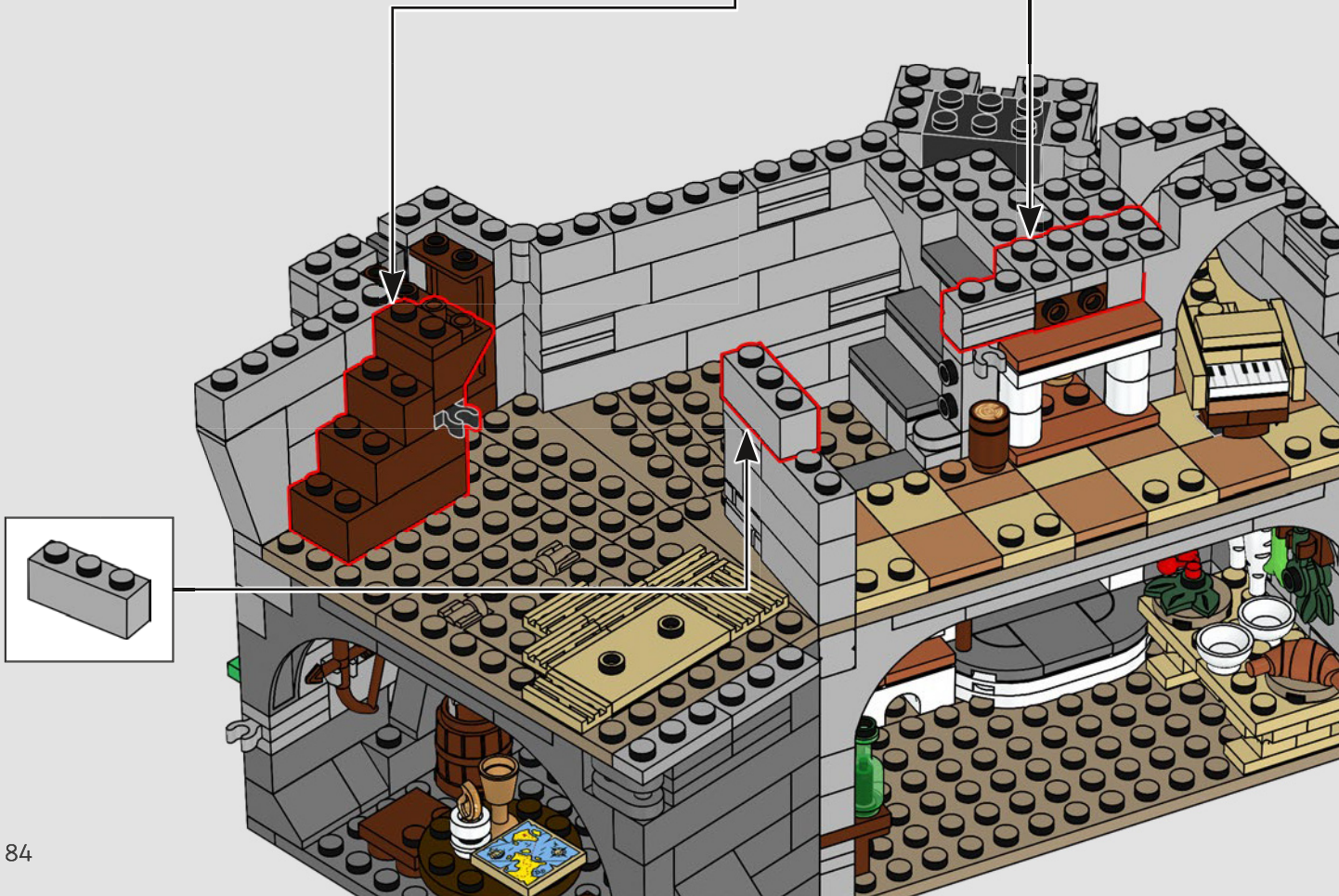
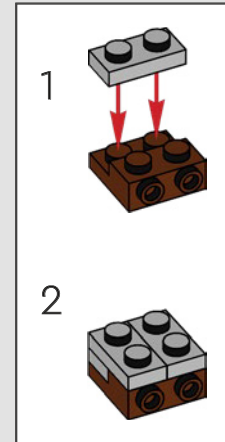
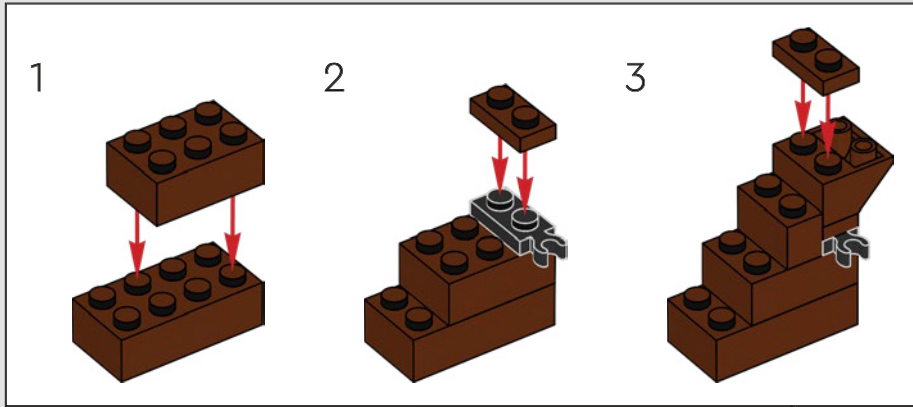

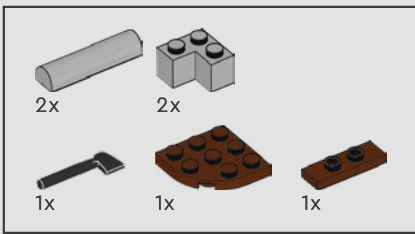

91

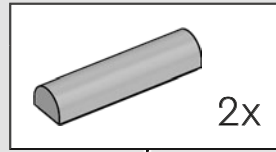

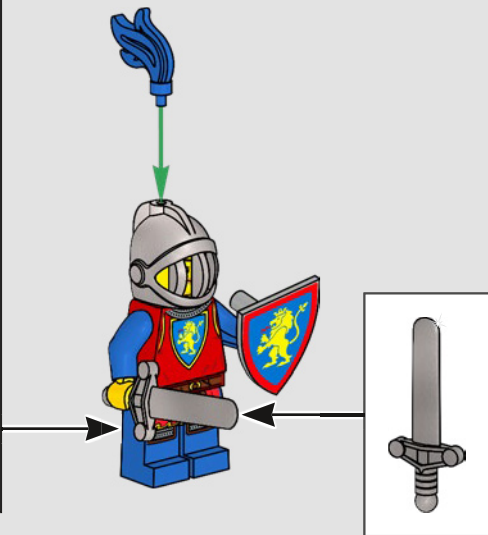
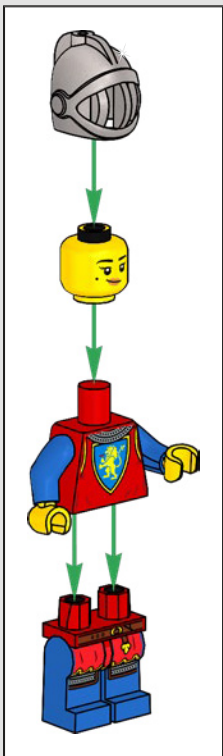

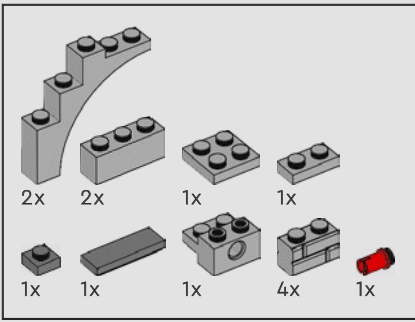

92

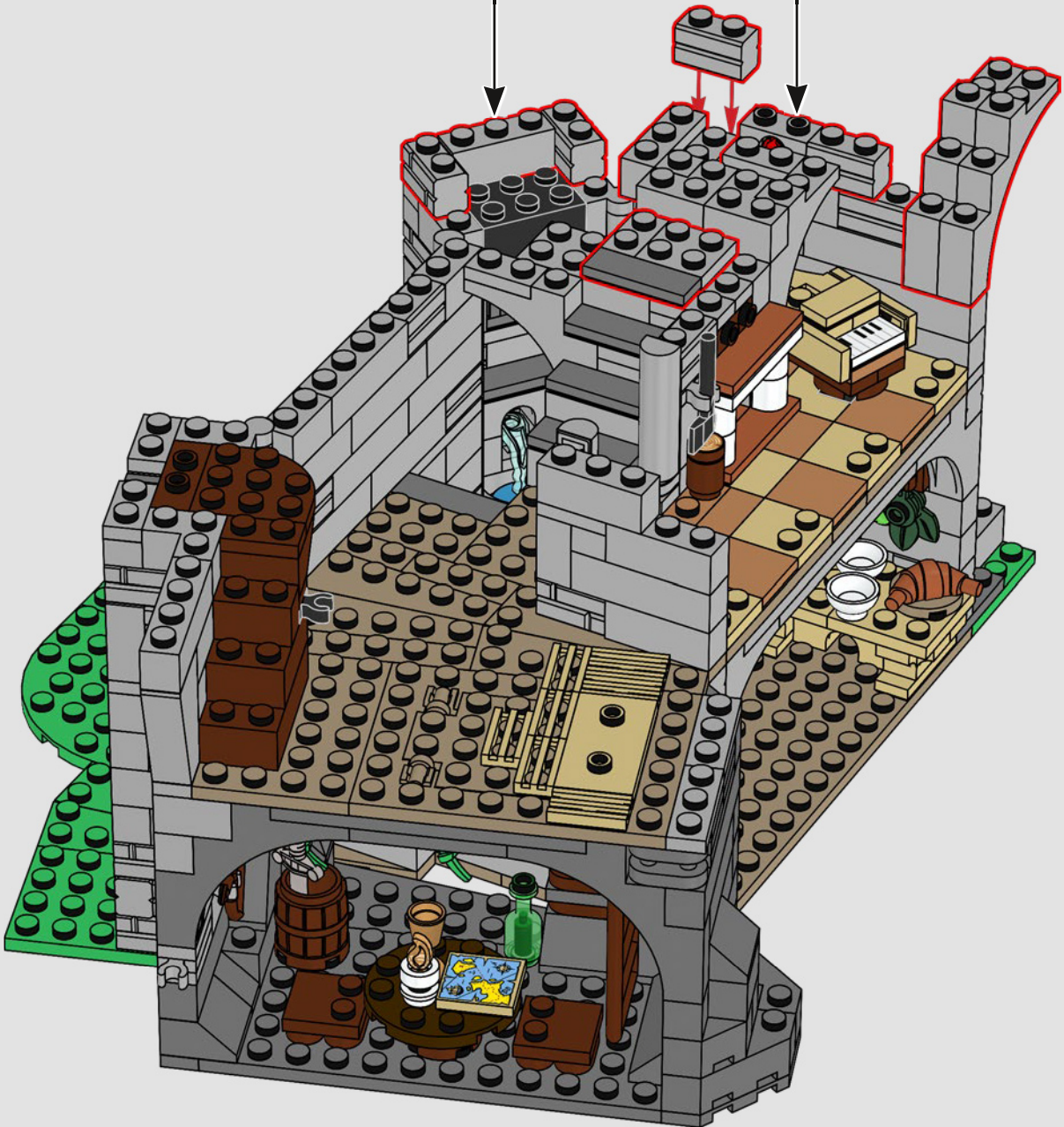
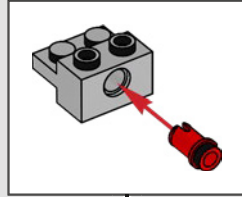
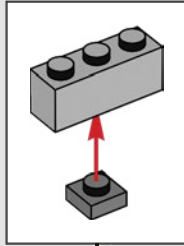

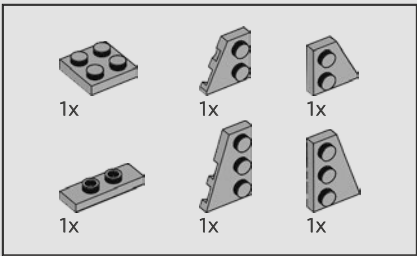

93

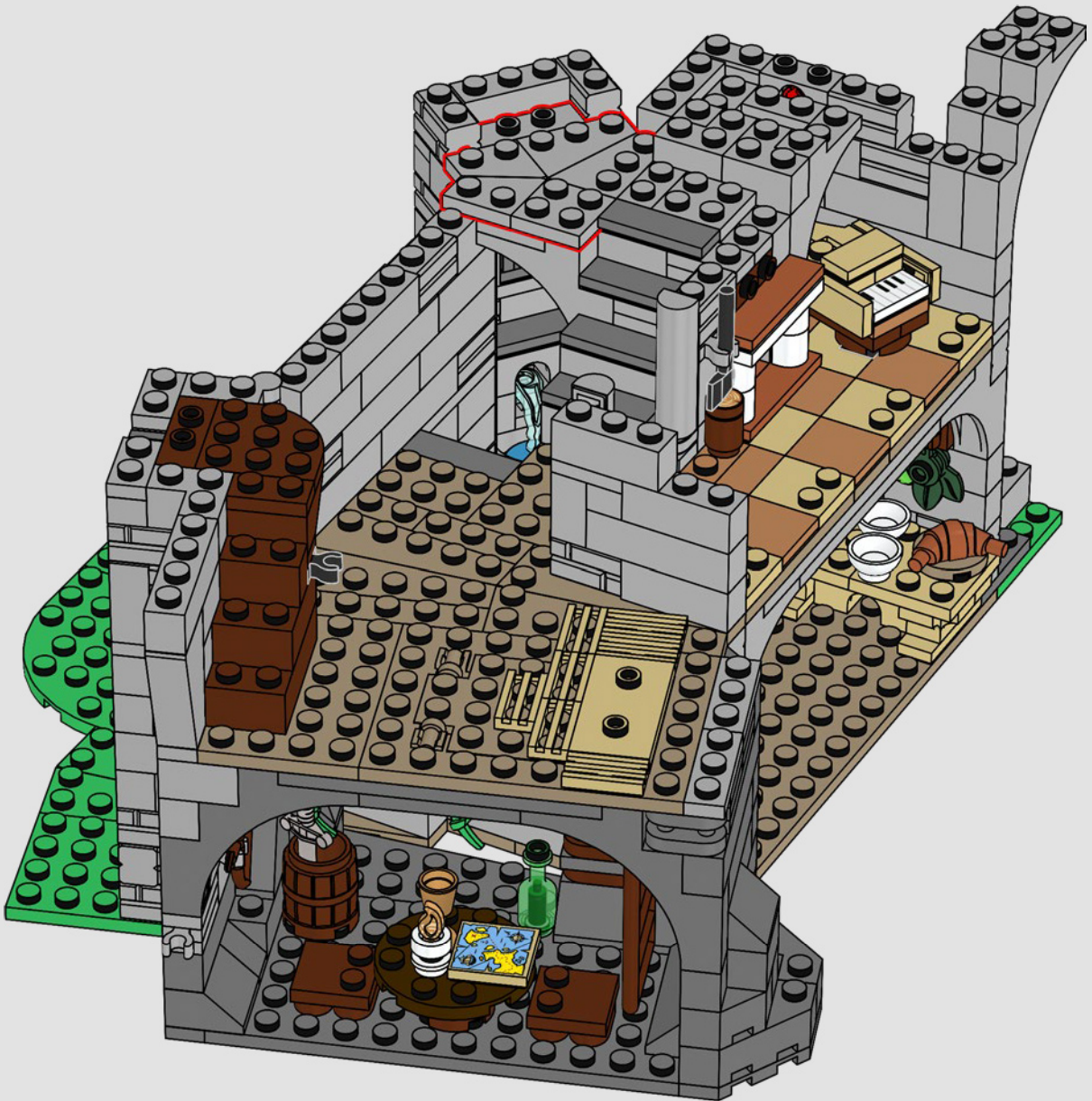

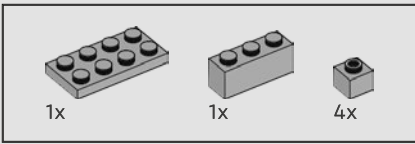

94

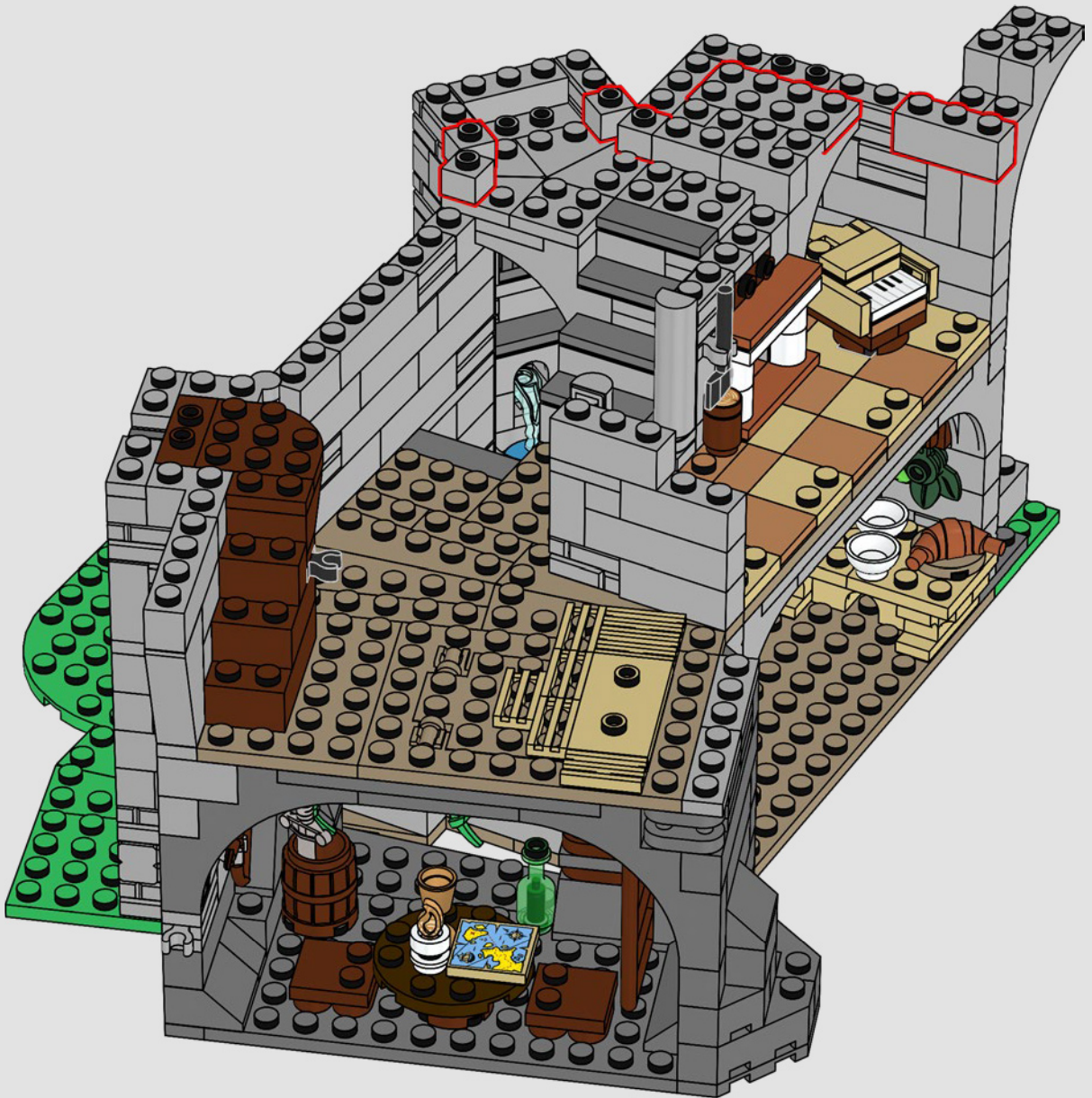

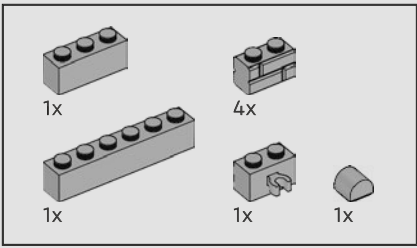

95

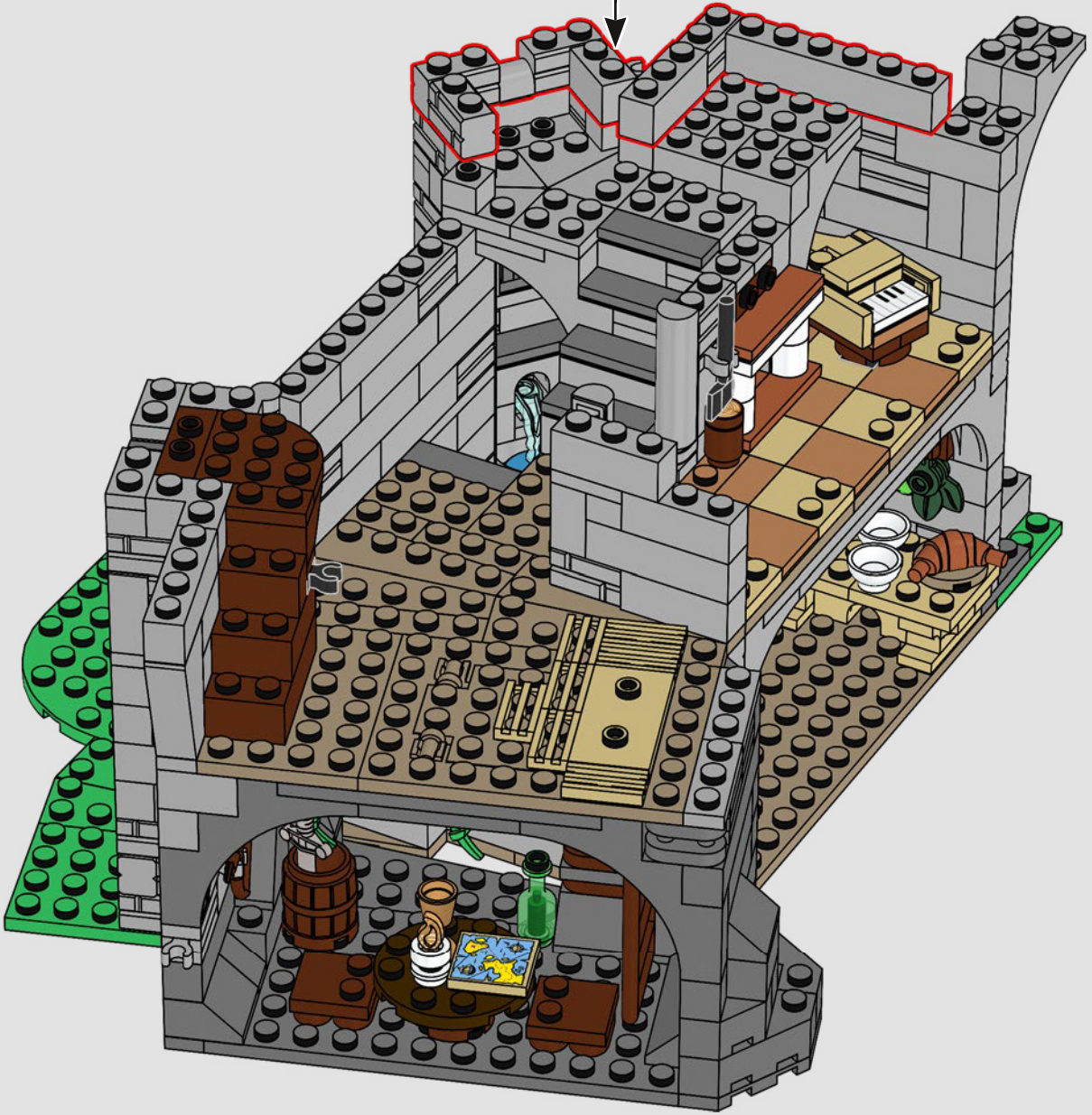
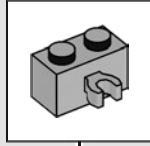

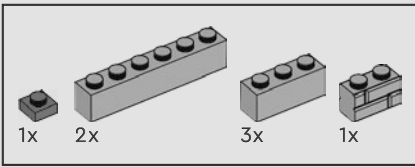

96

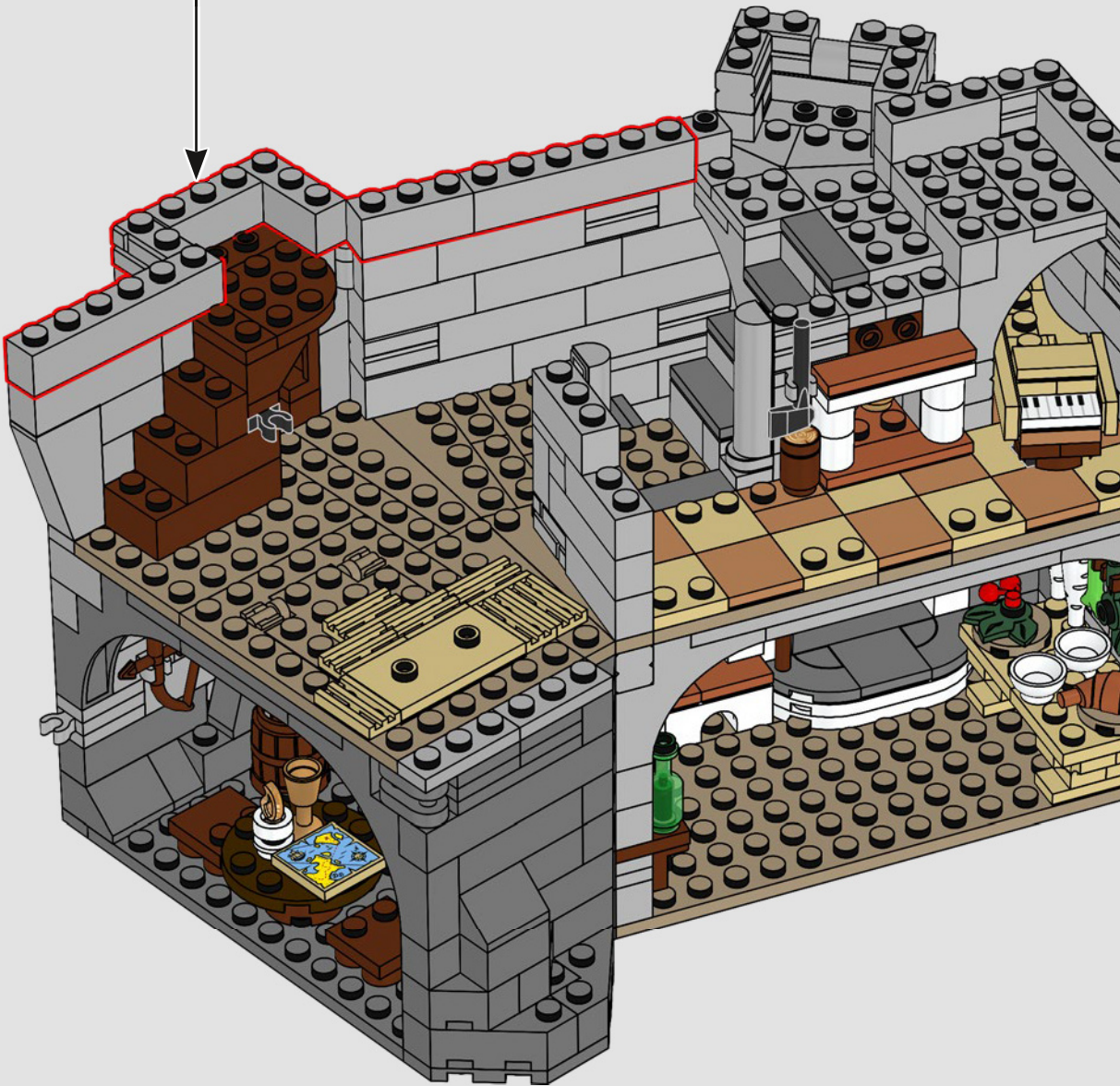
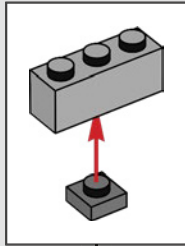

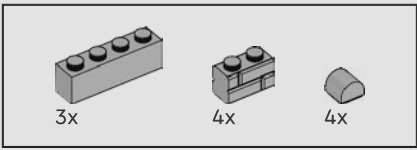

97

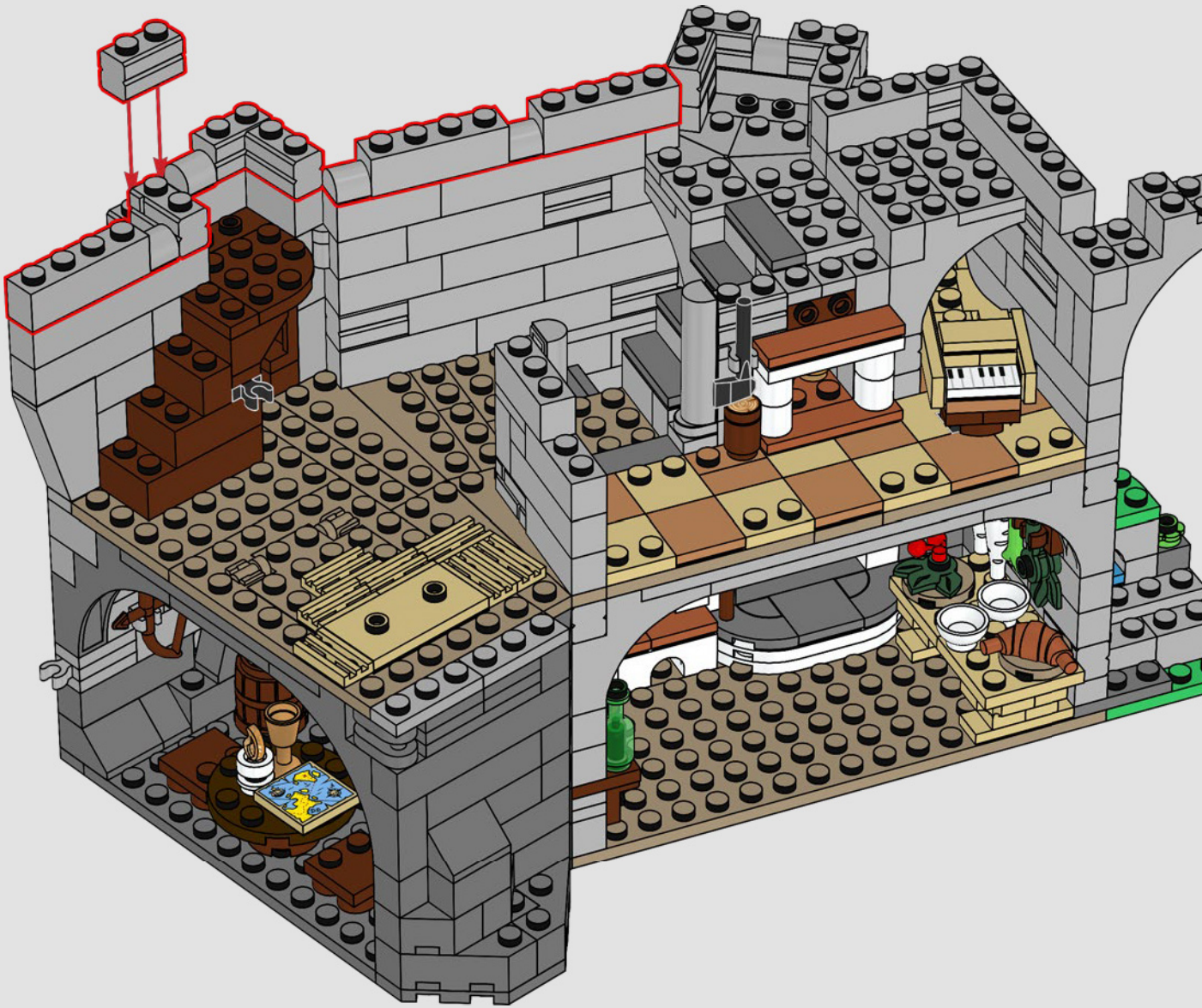



¡Jamás se vieron almenas tan majestuosas sobre el muro cortina!

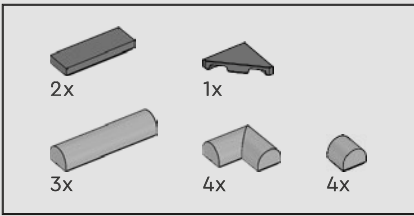

98

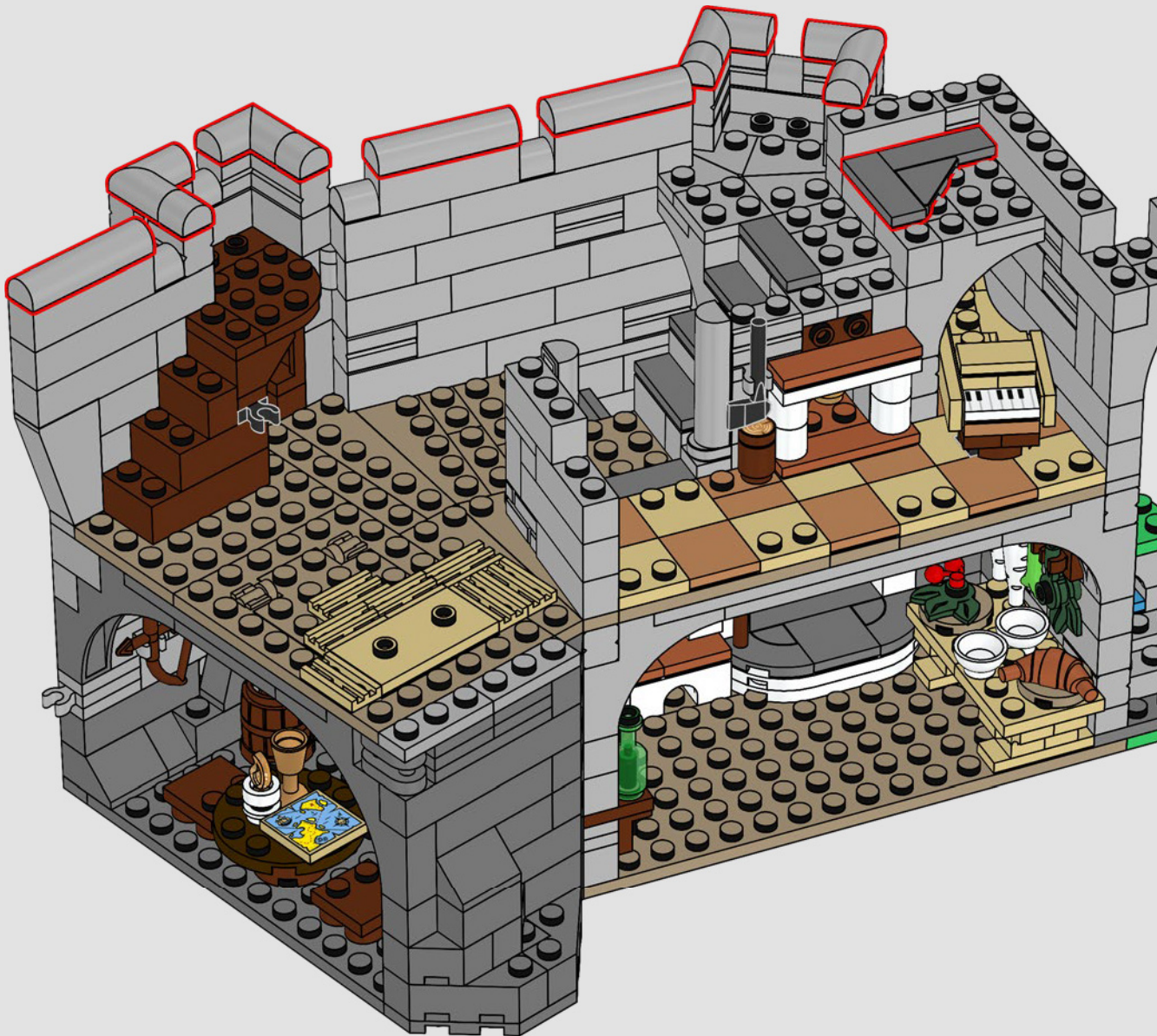

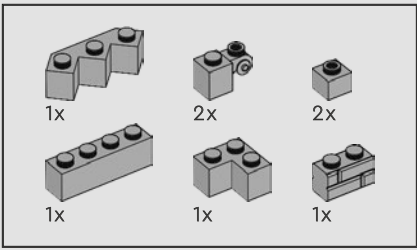

99

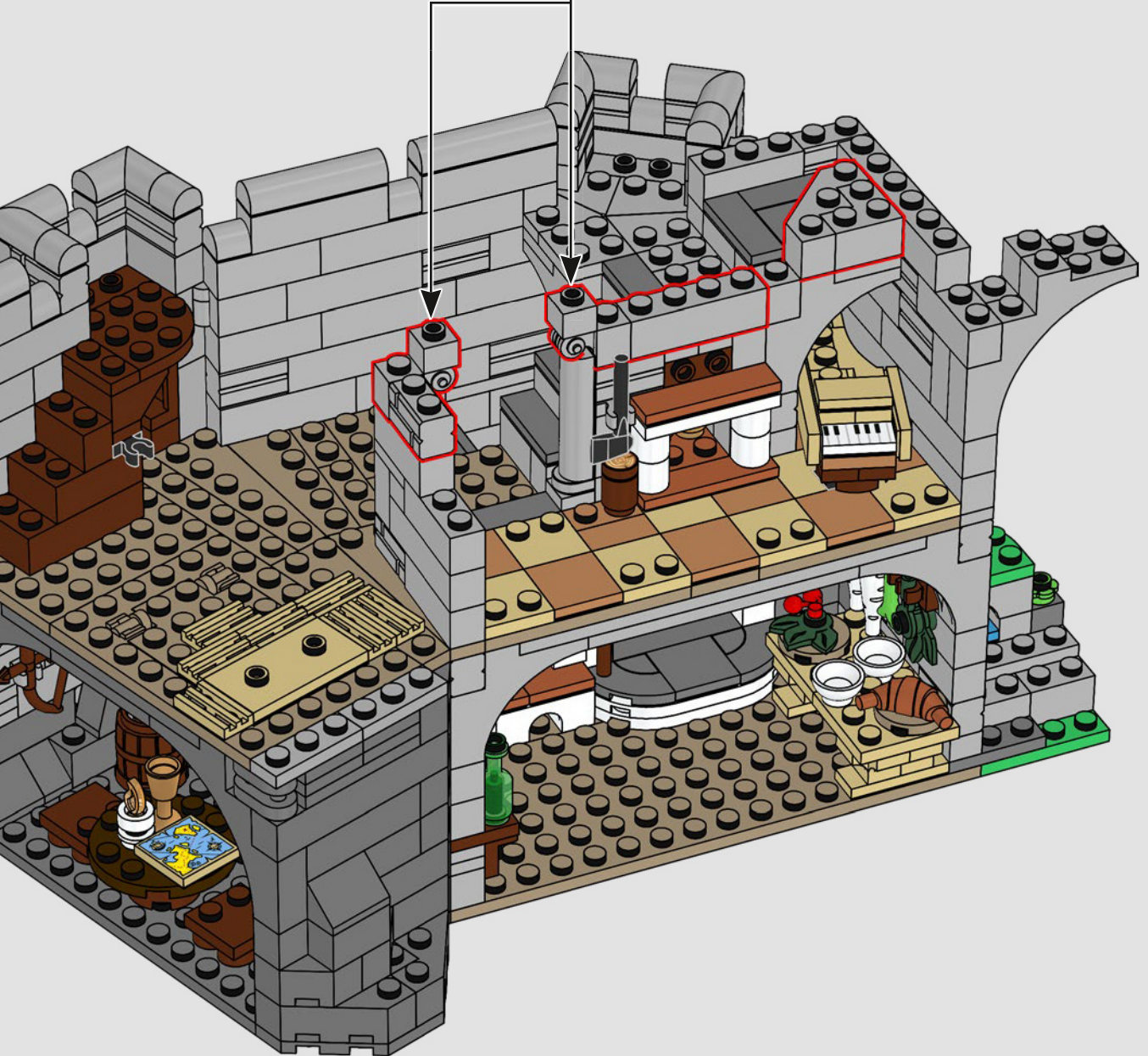
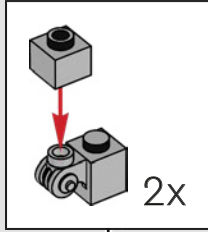

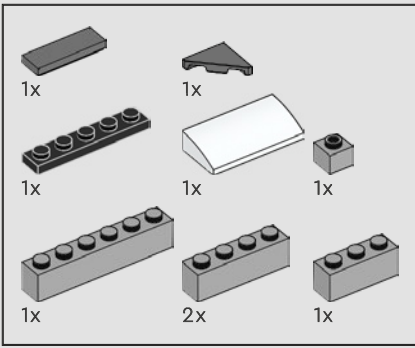

100

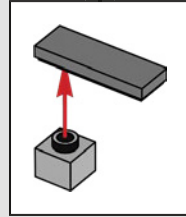
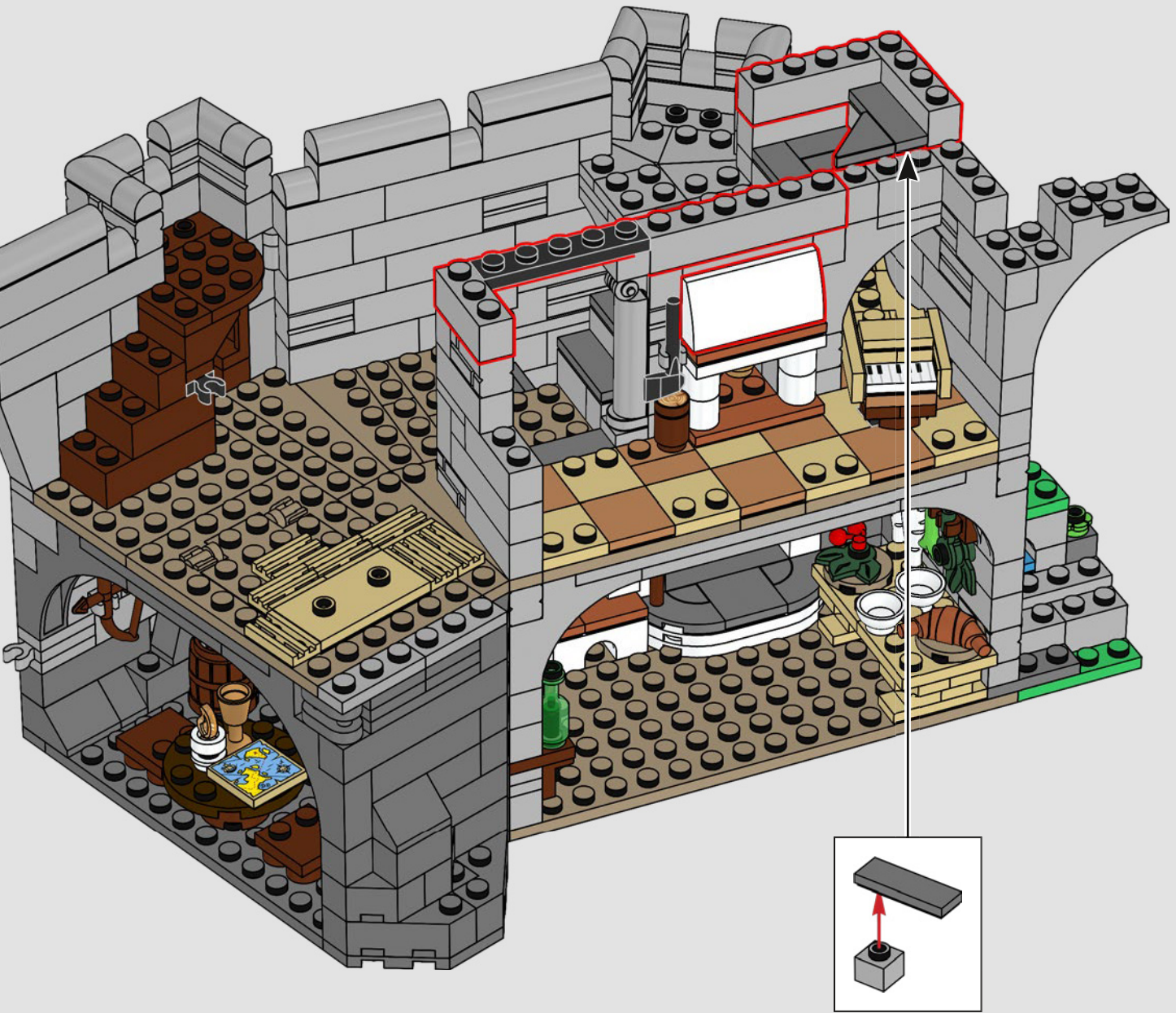

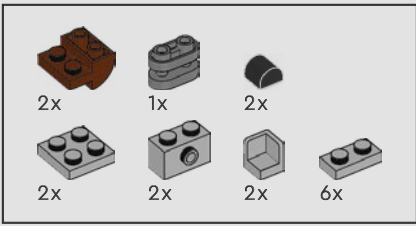

101

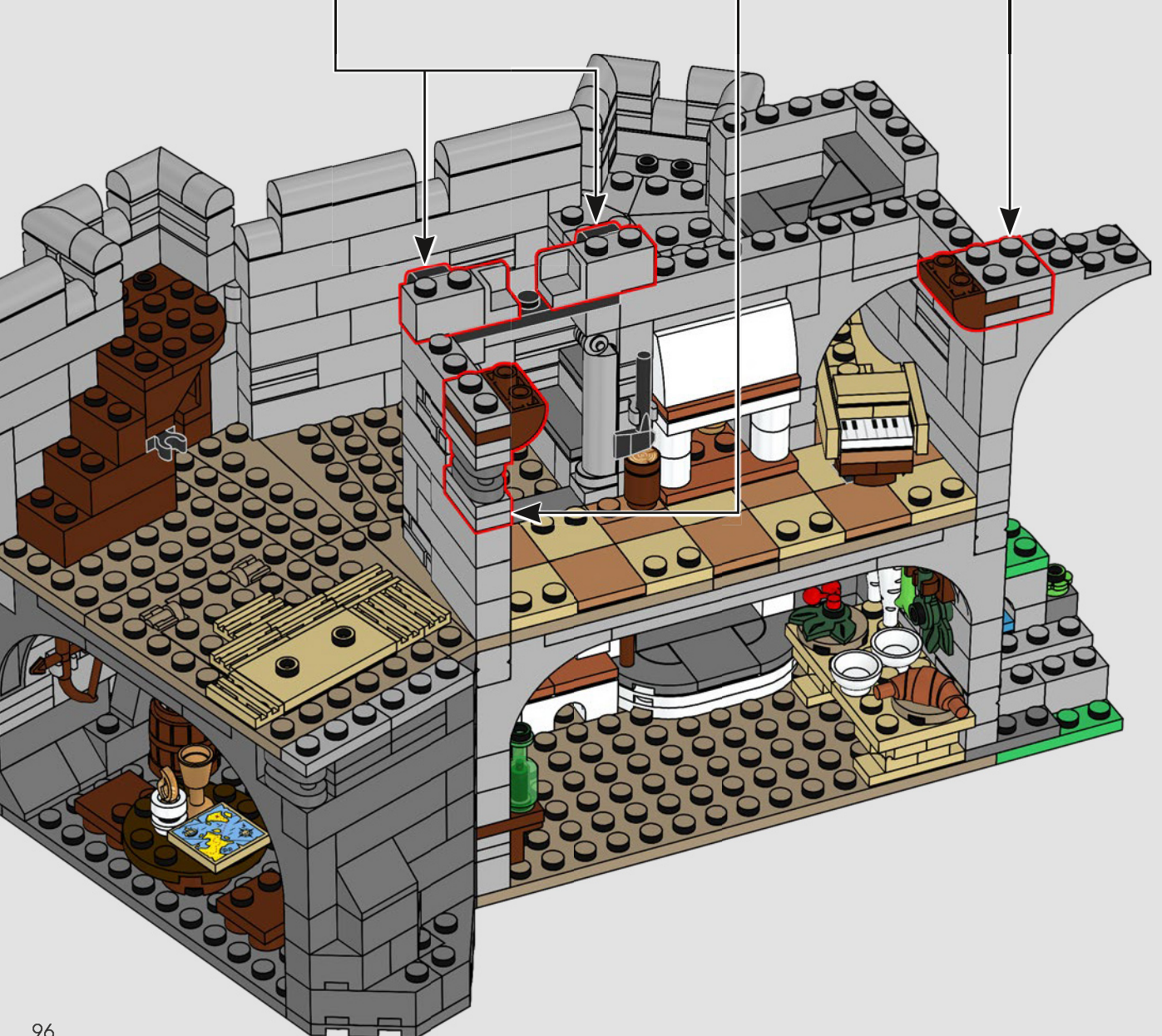
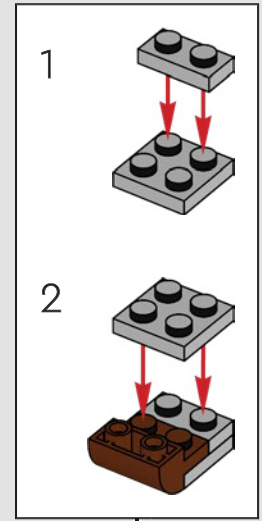
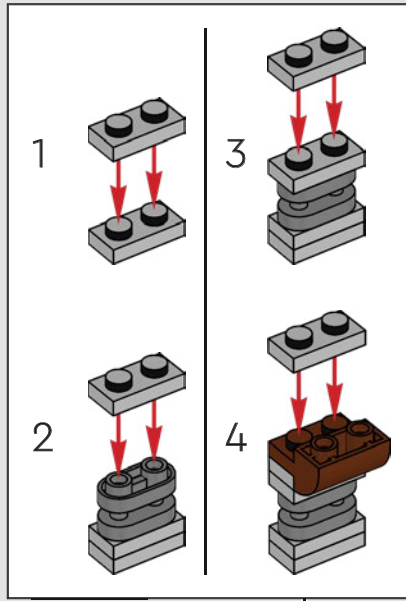
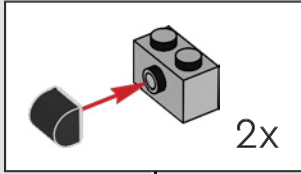

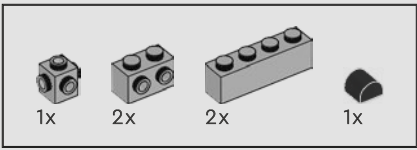

102

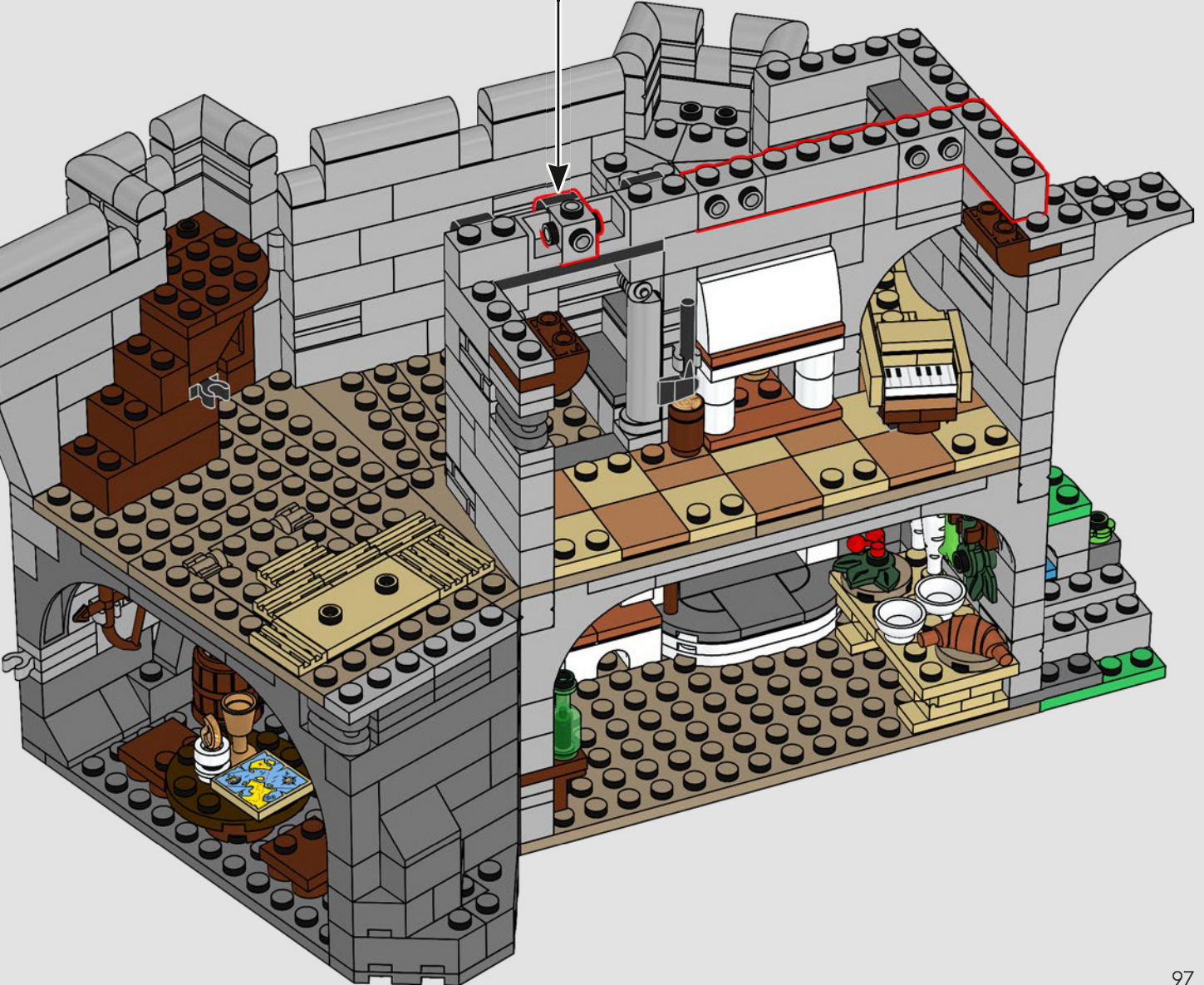
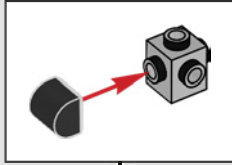

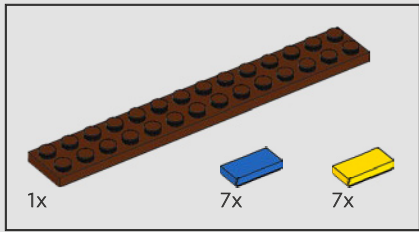

103

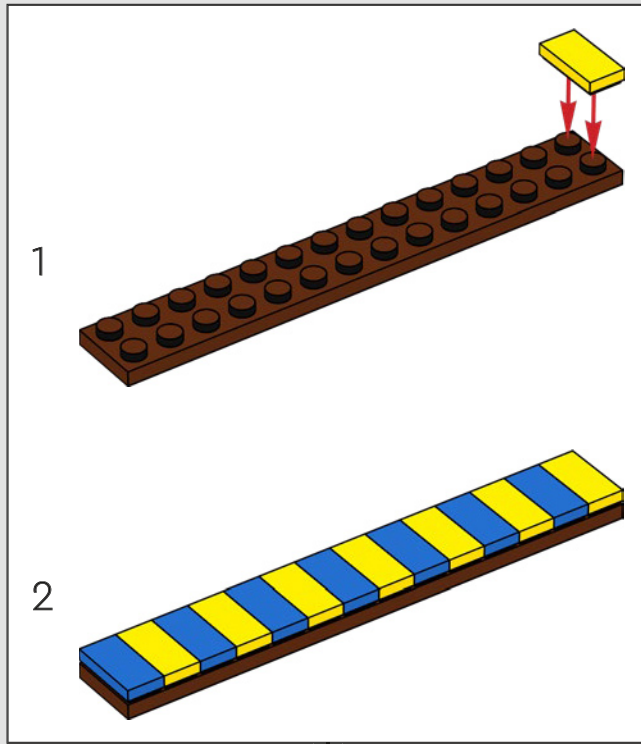

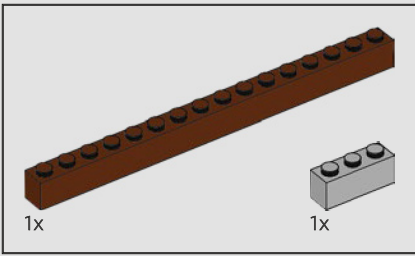

104



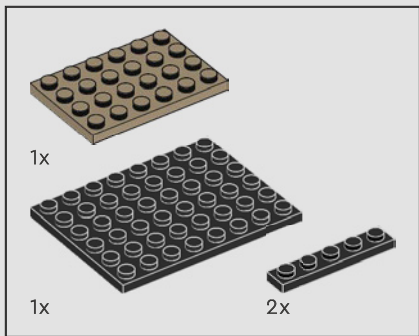

105

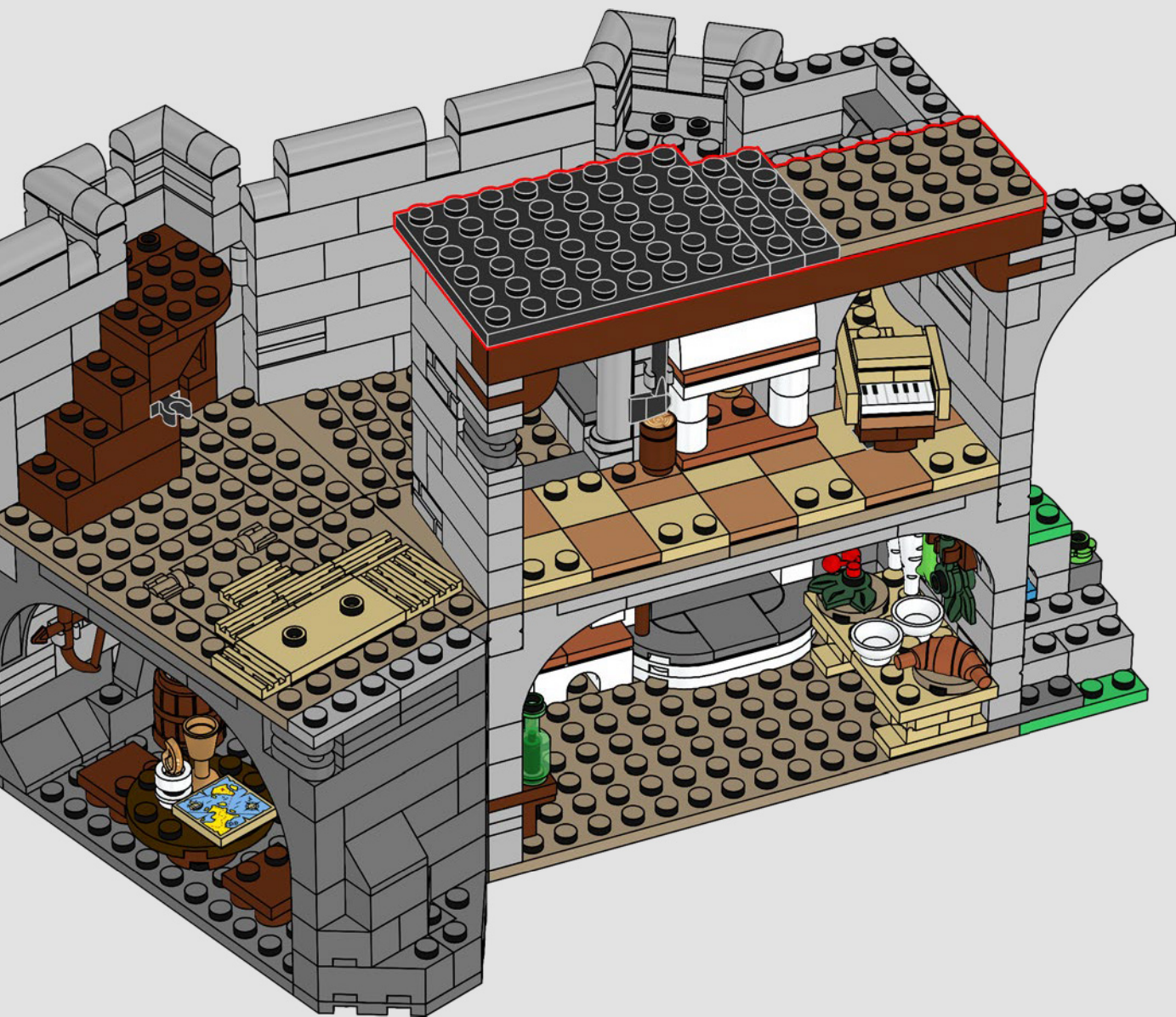

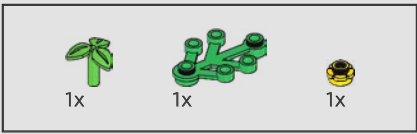

106

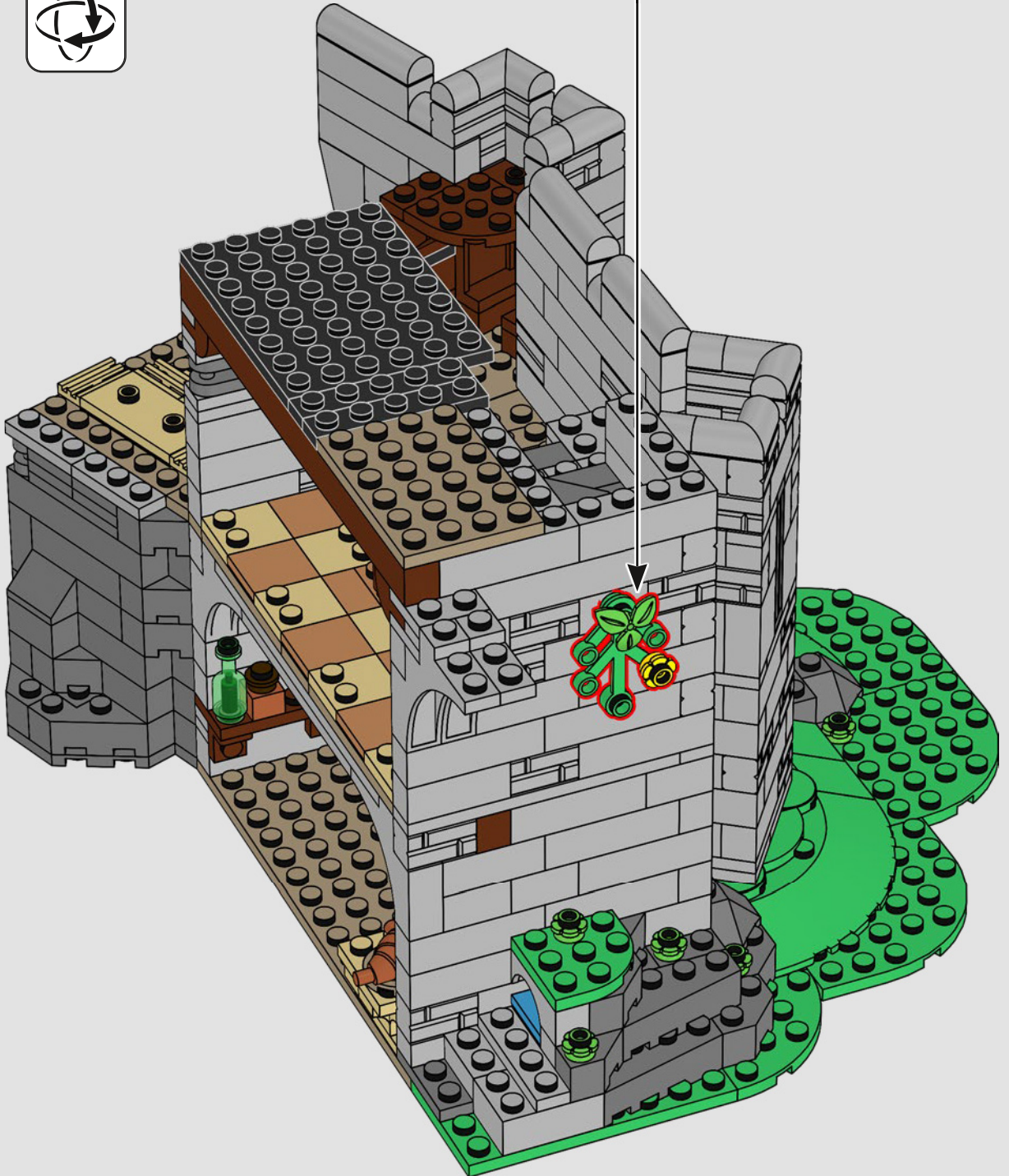
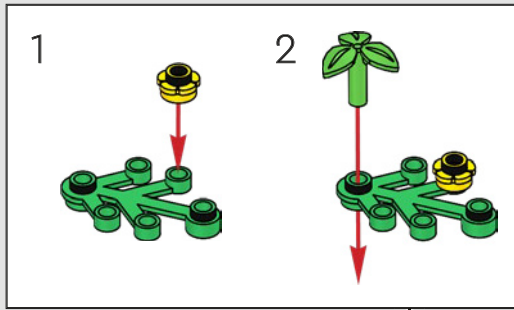

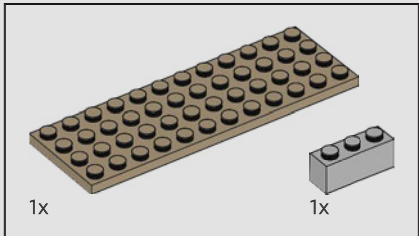
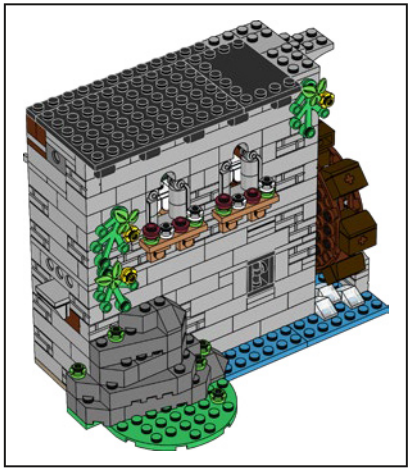

107

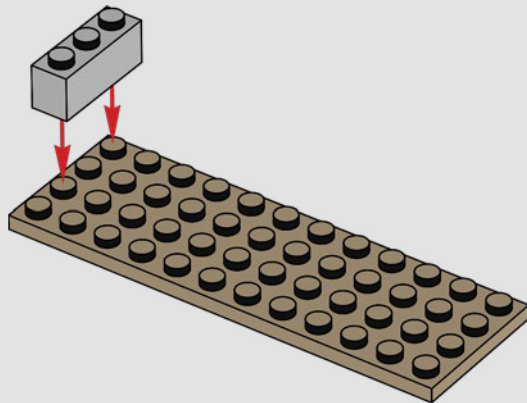

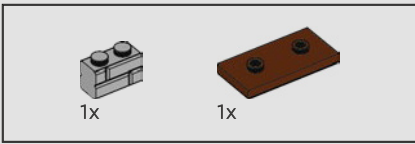

108

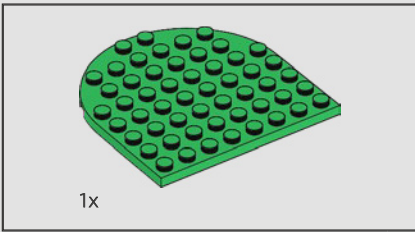
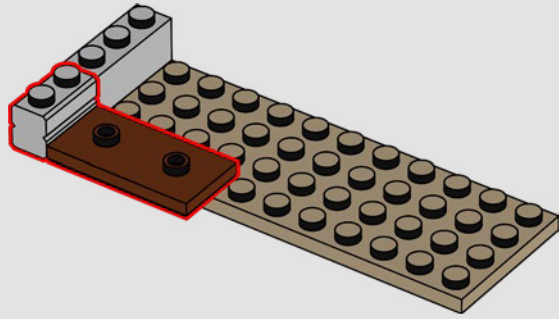

109

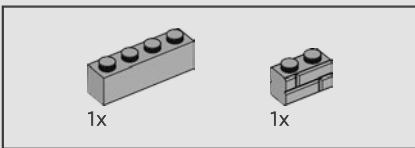
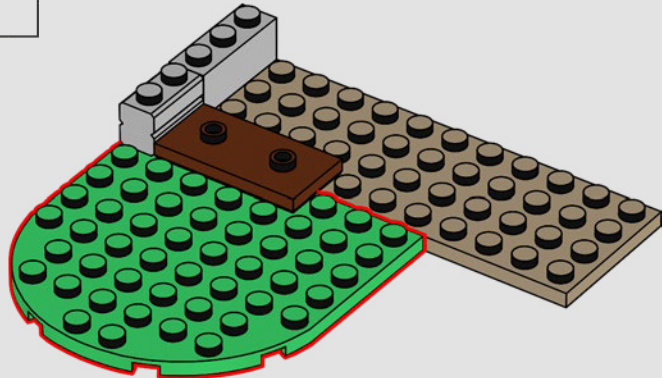

110

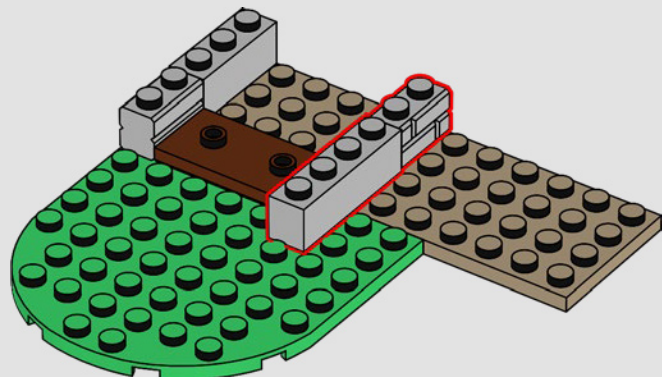

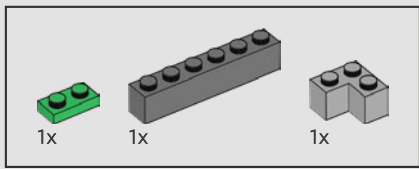

111

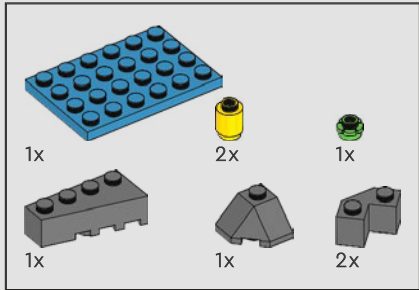
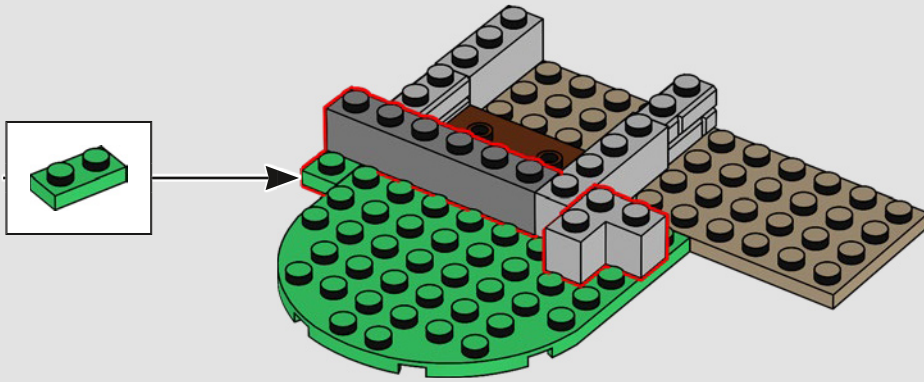

112

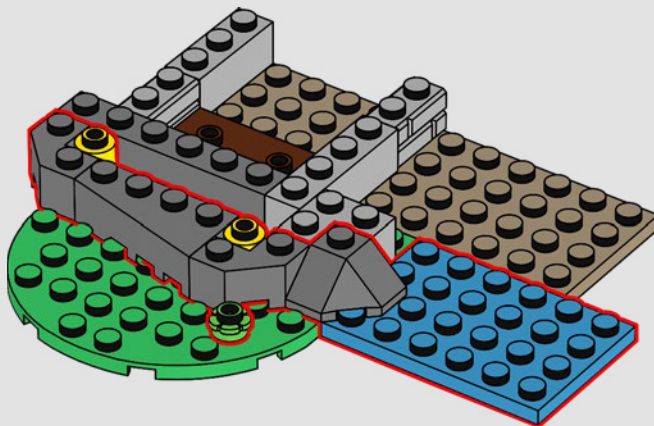

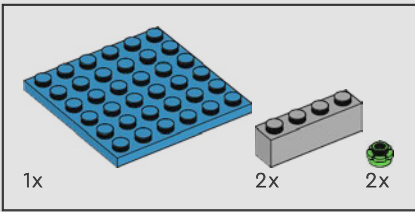

113

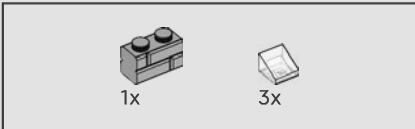
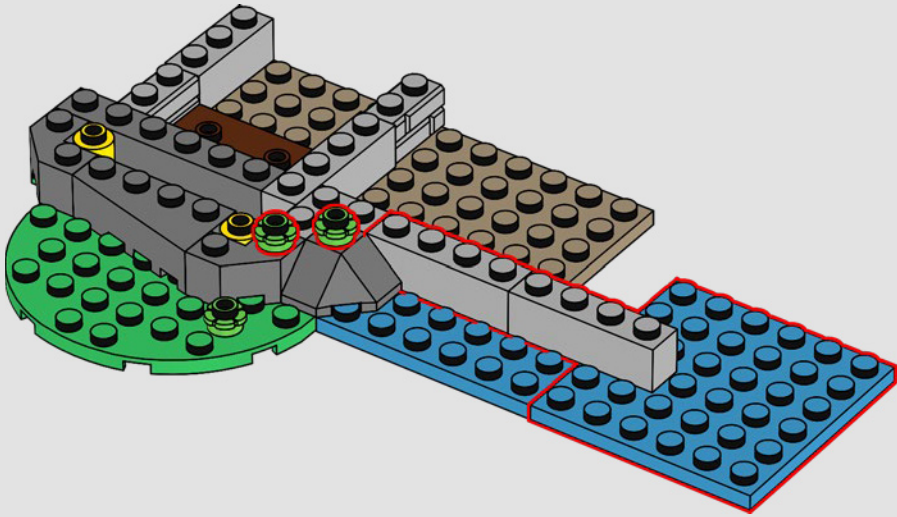

114

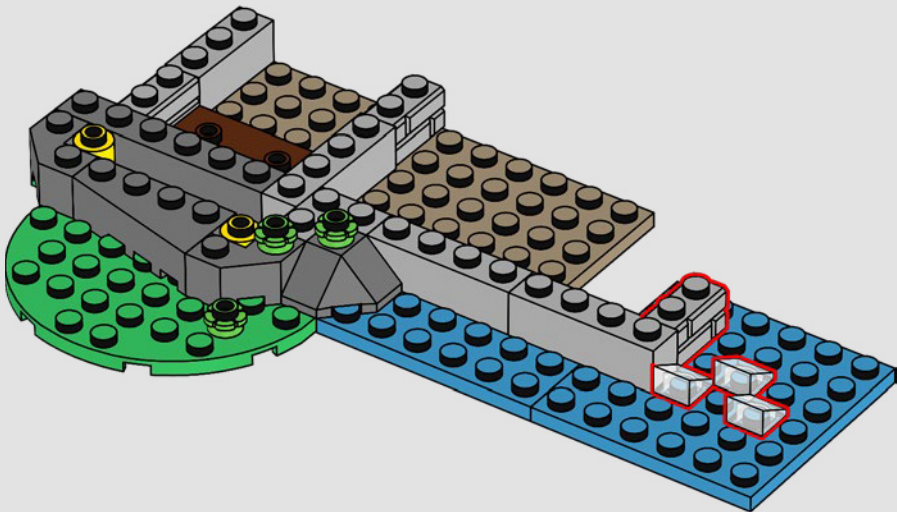

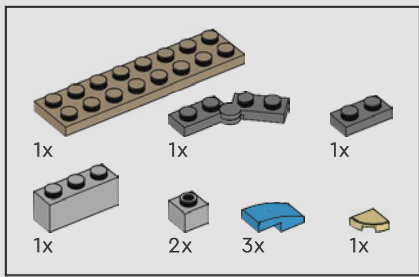

115

1

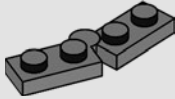

2

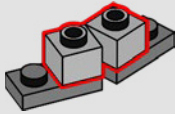

3

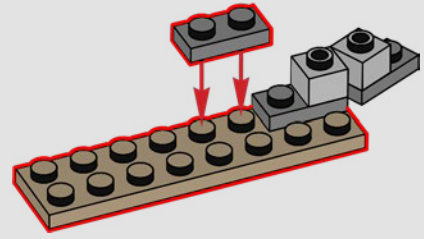

4

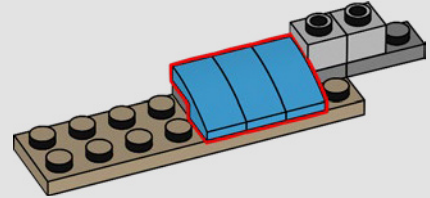

5

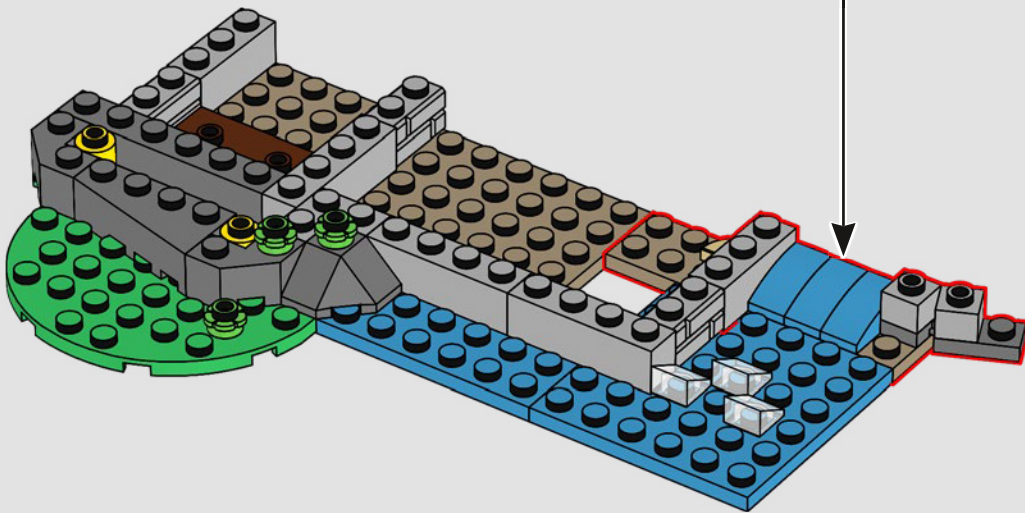
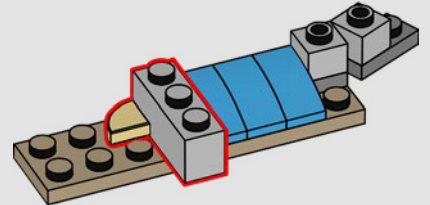

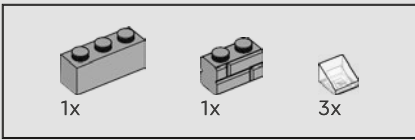

116

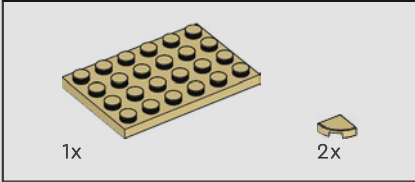
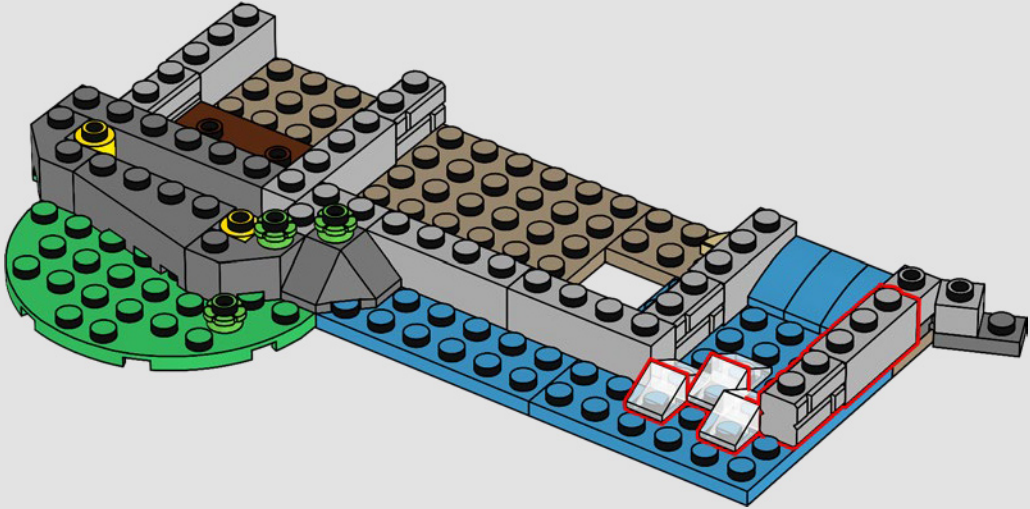

117

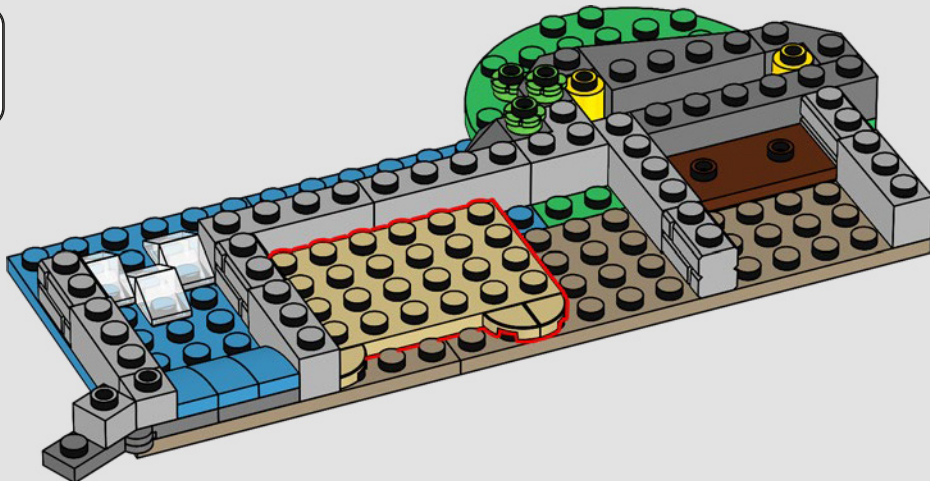



Parece un buen lugar para un molino de algún tipo... Podría incluso impulsarse con la fuerza del arroyo...

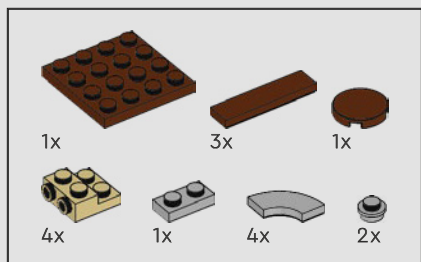

118

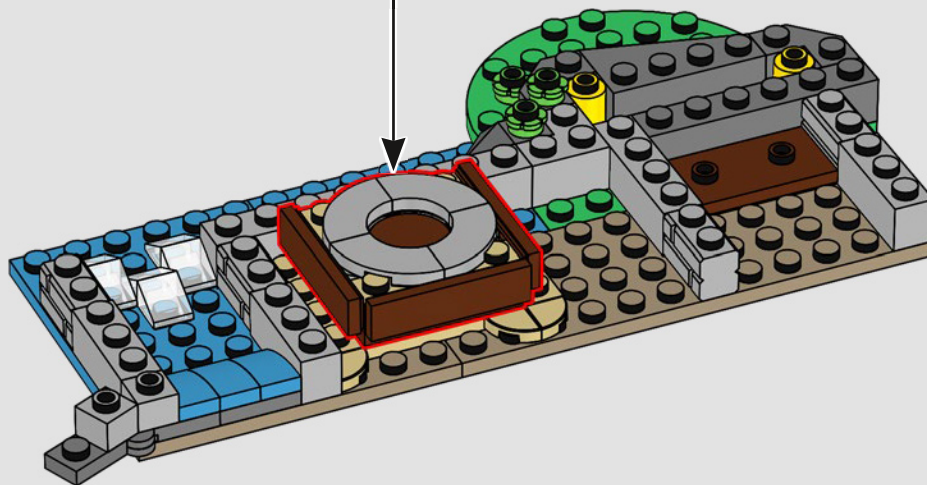
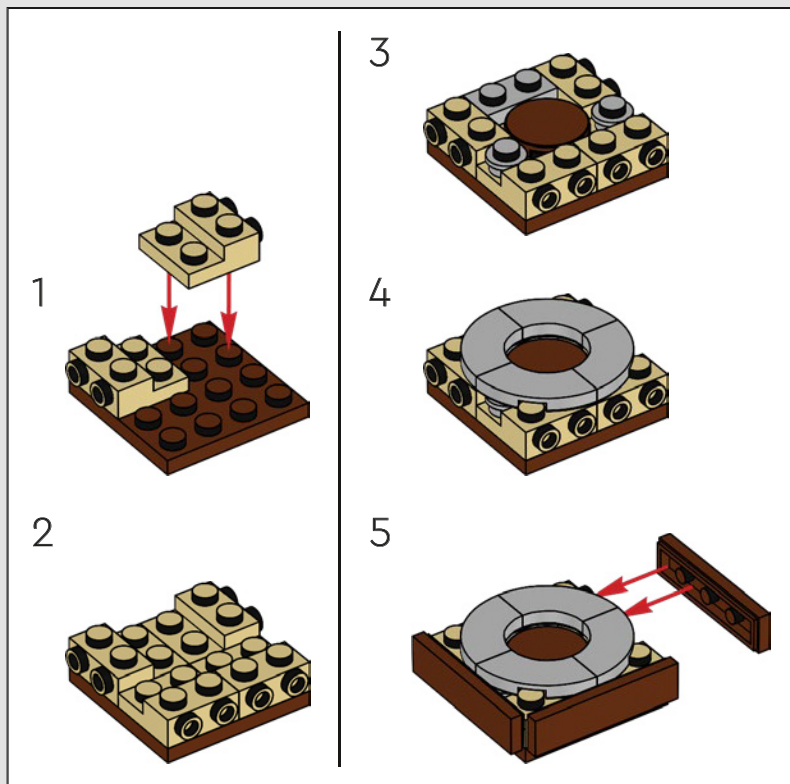

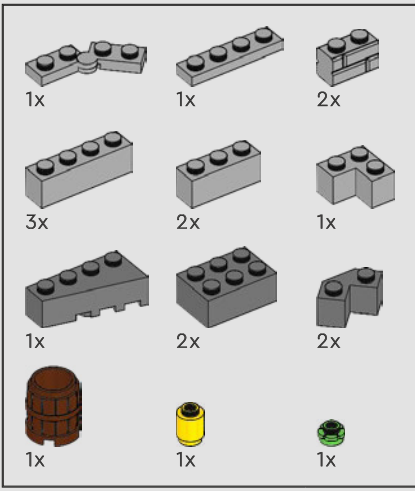

119

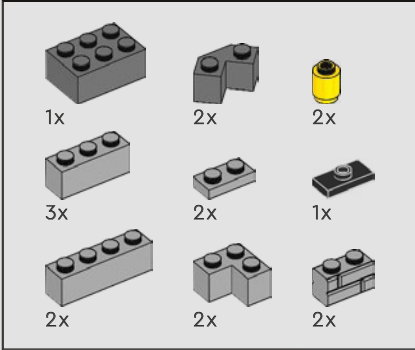
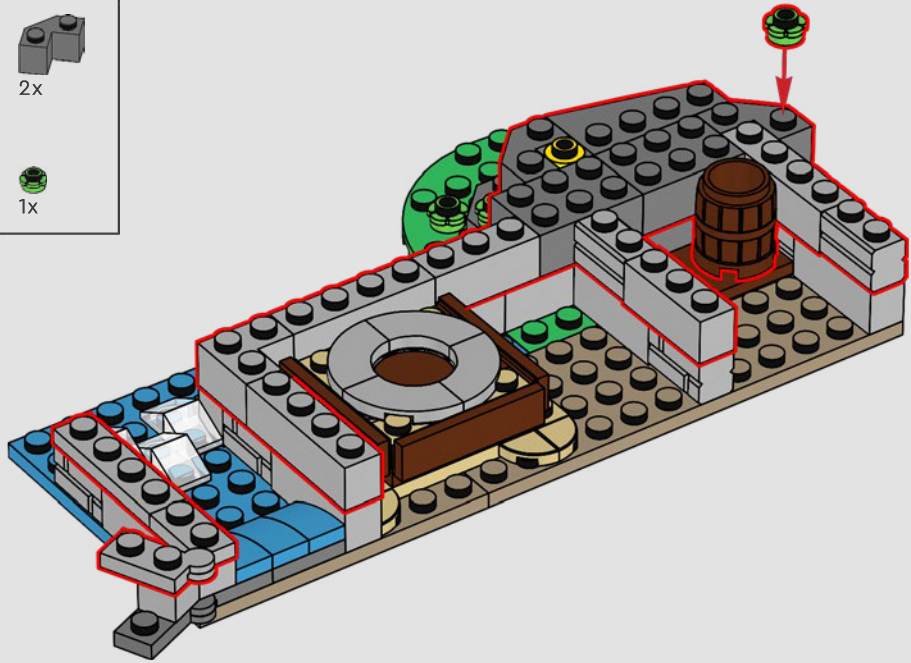

120

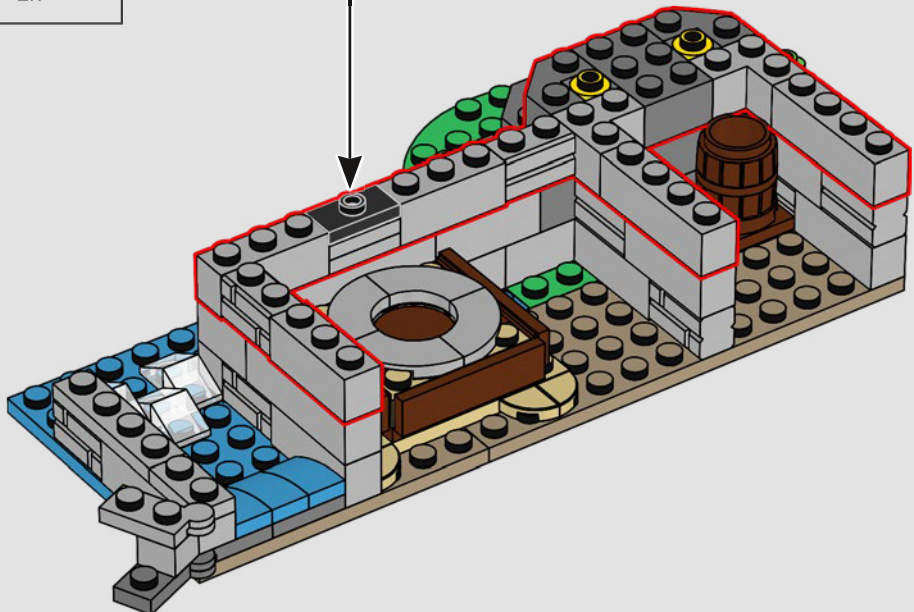
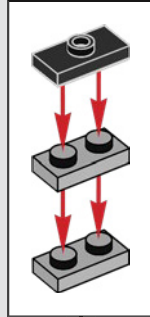

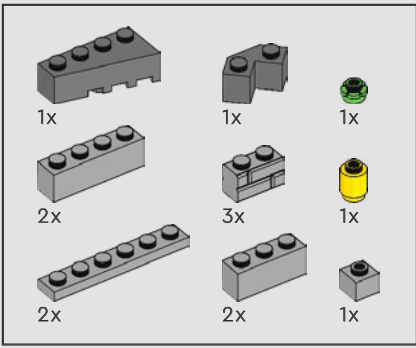

121

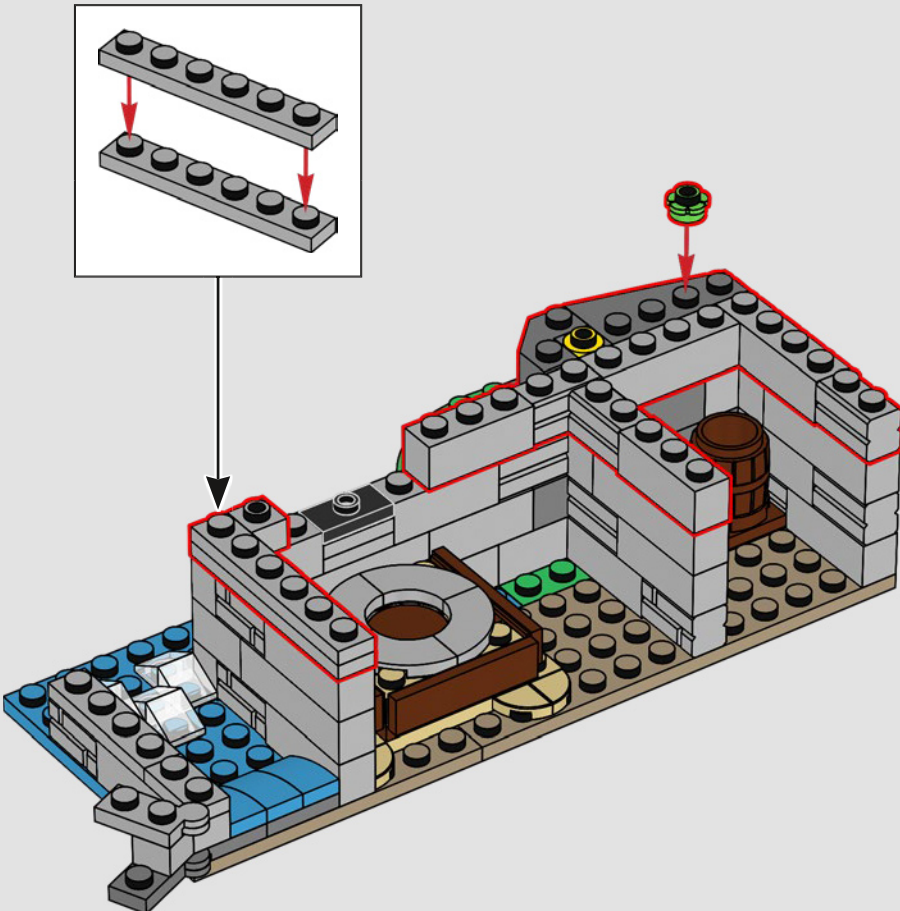

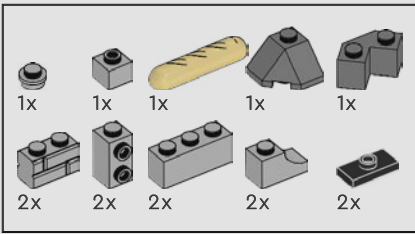

122

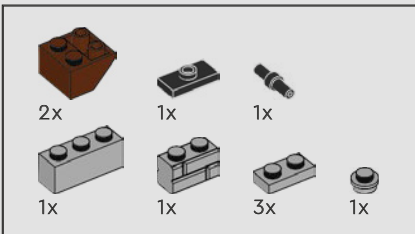
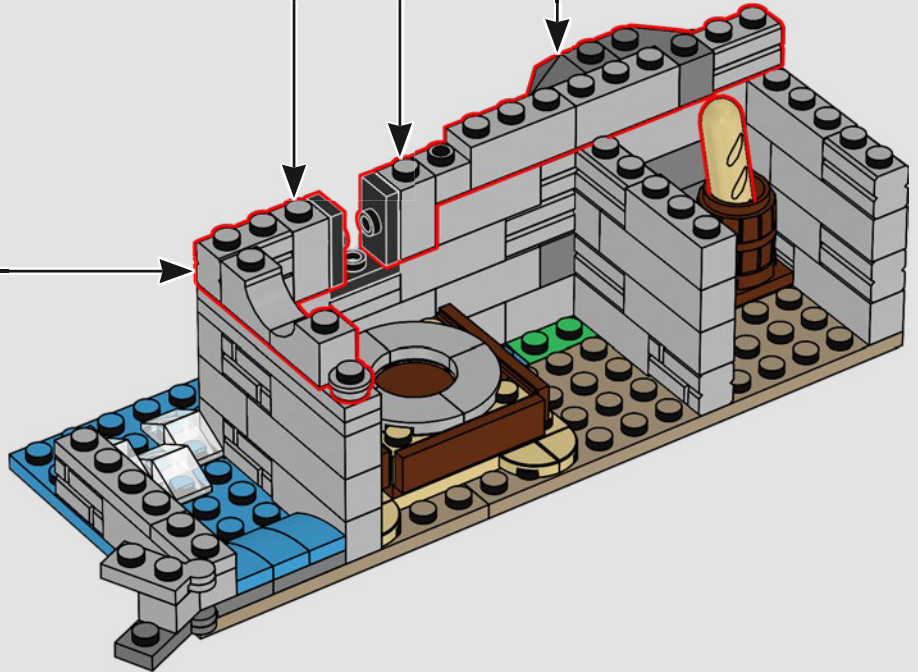
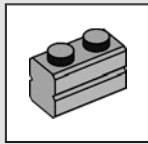
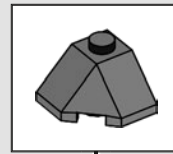
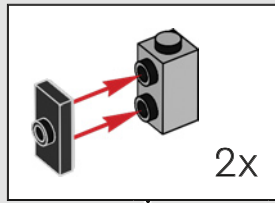

123

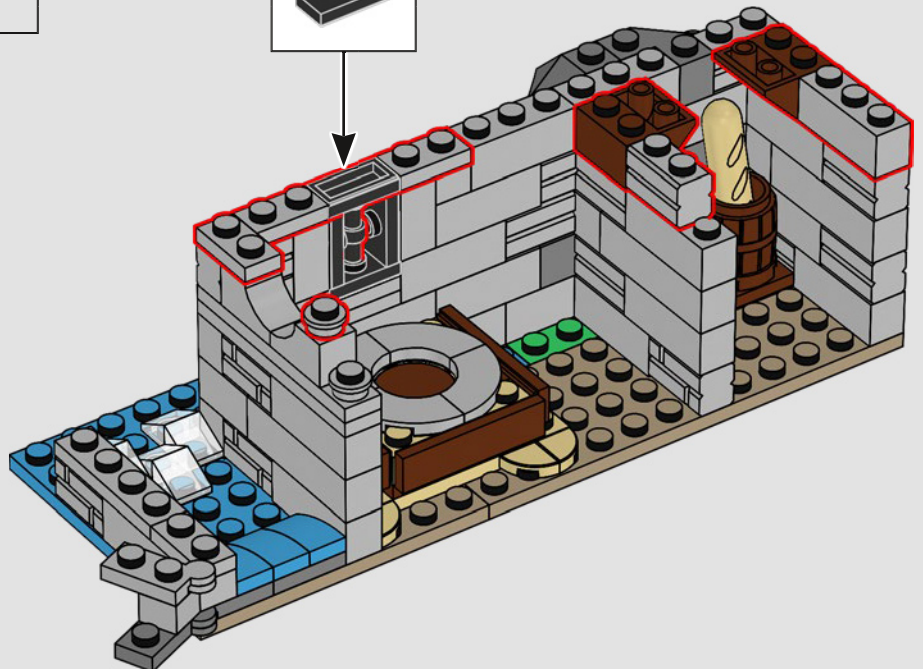
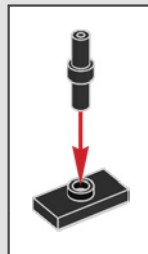

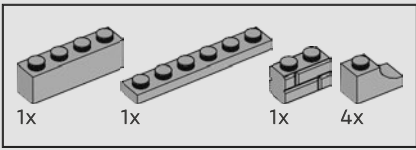

124

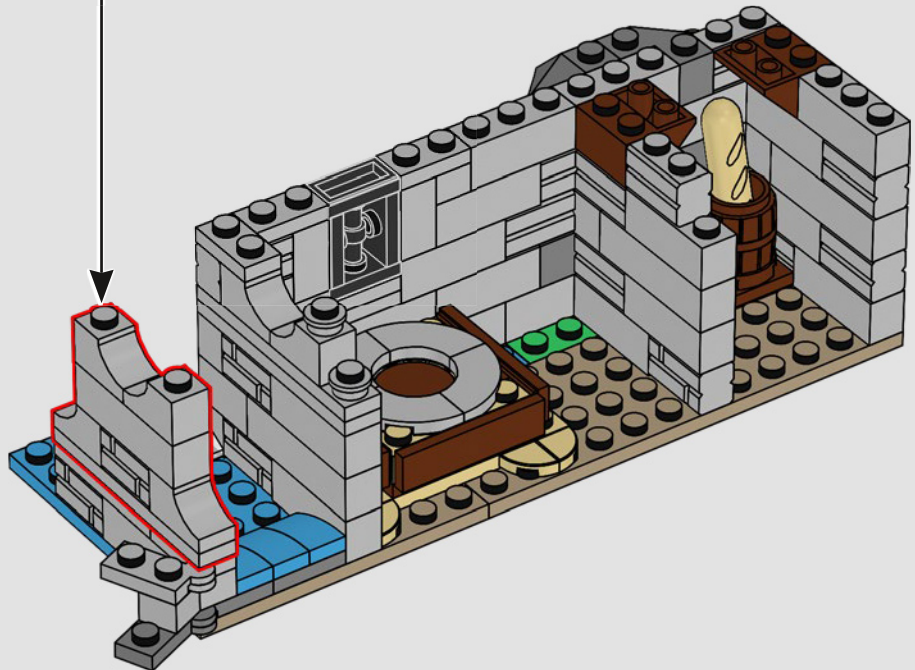
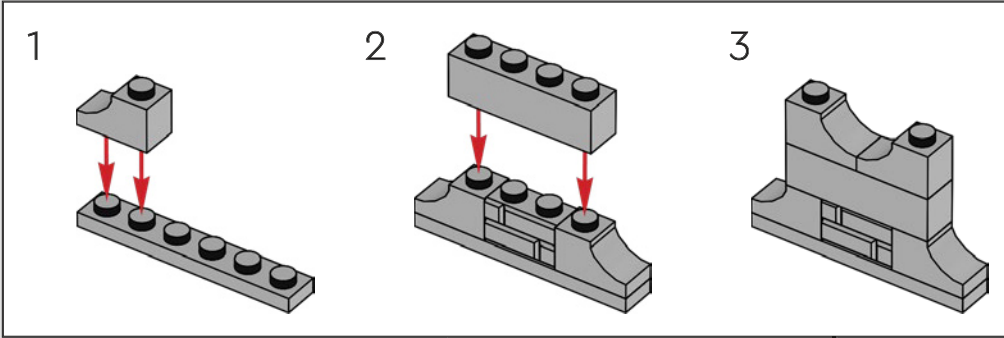

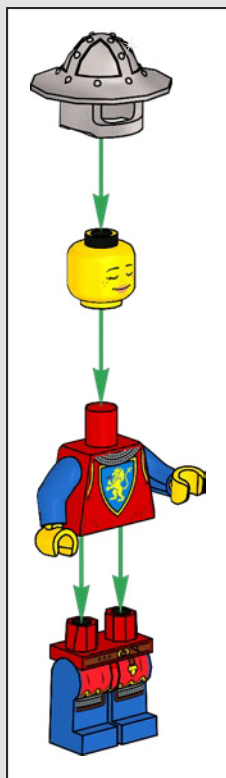

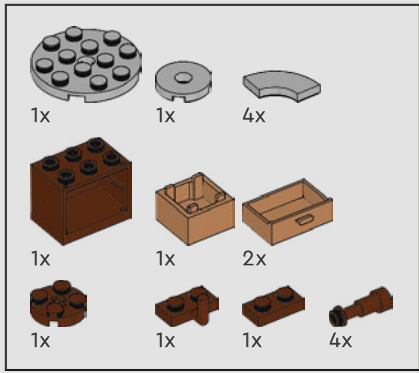

125

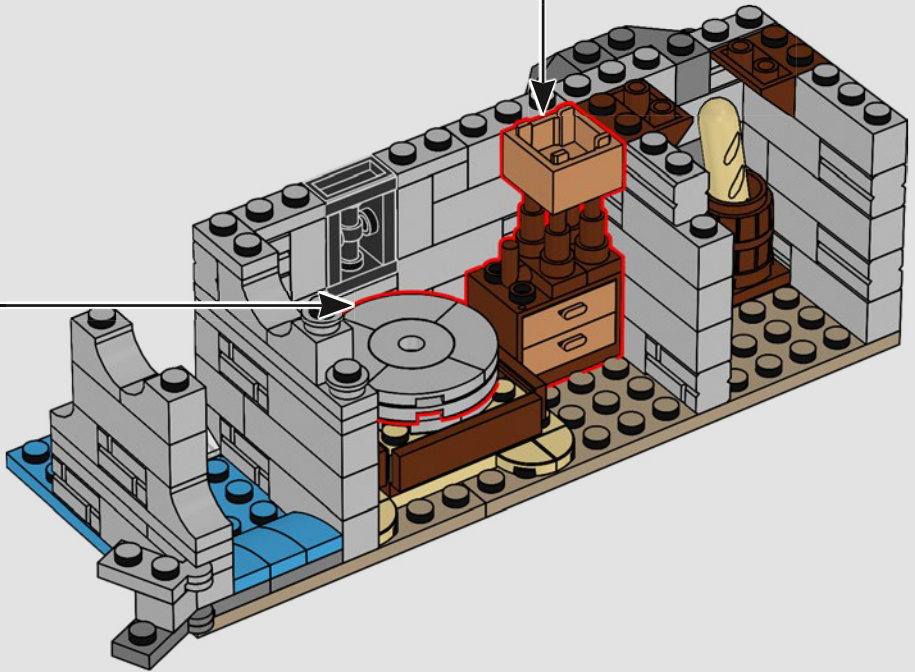
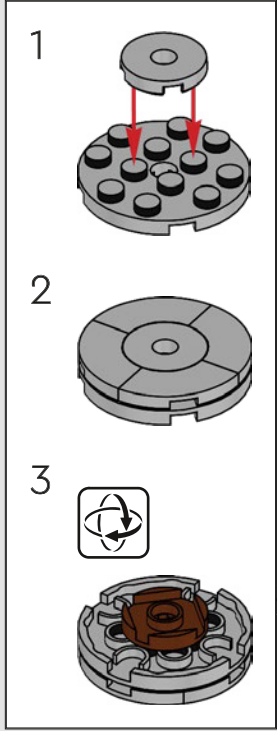
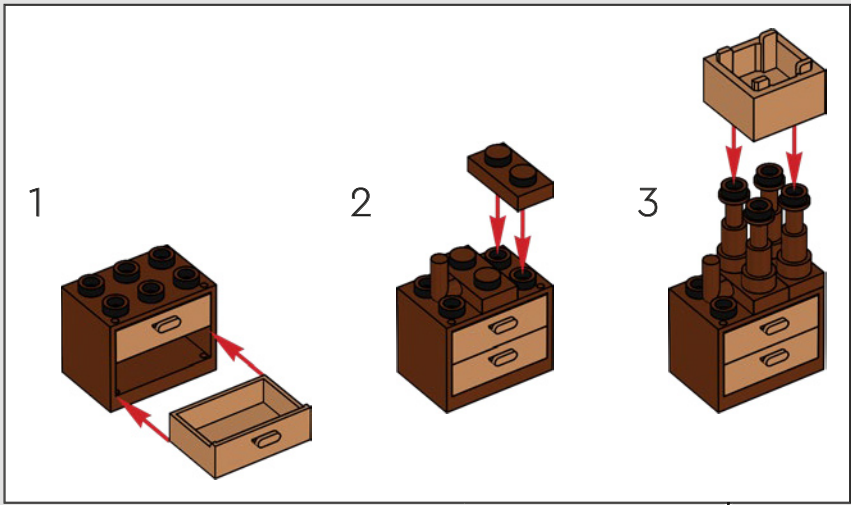

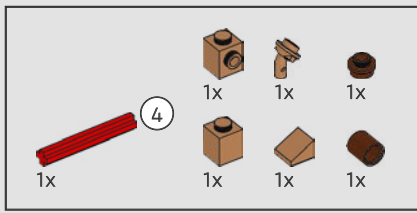

126

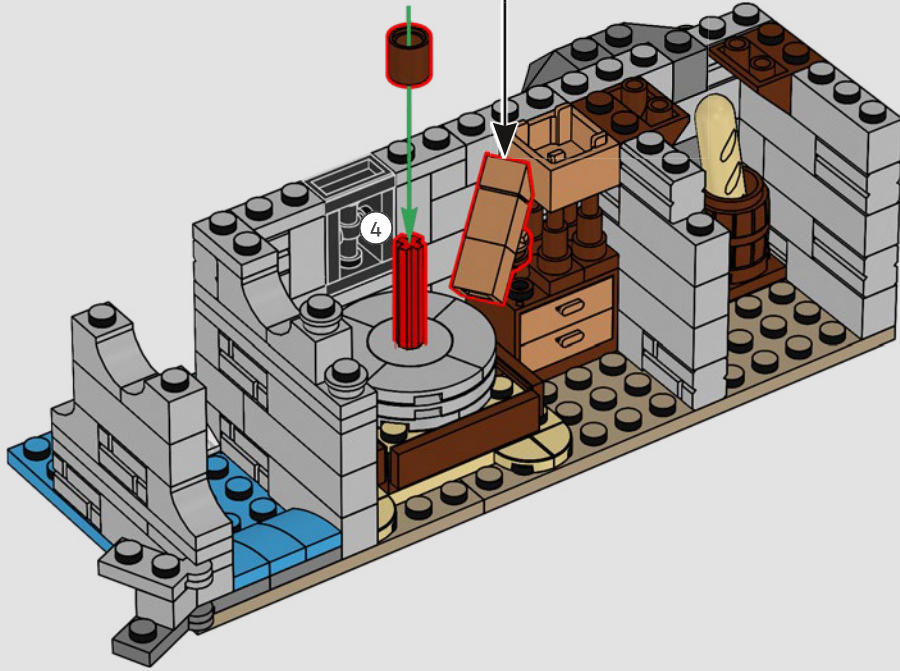
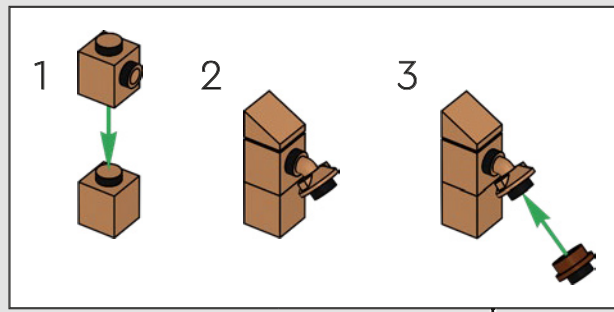

127

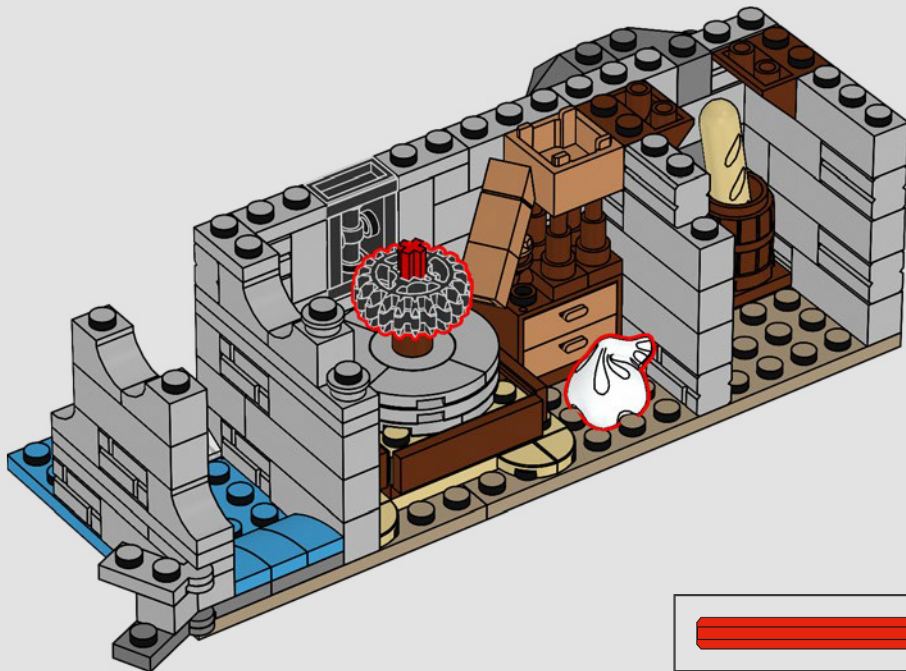

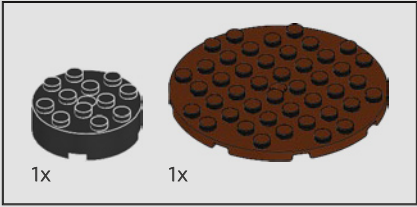
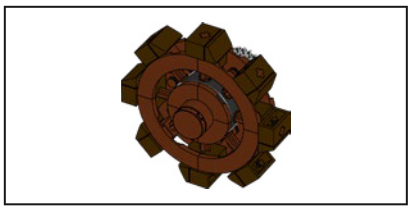

128

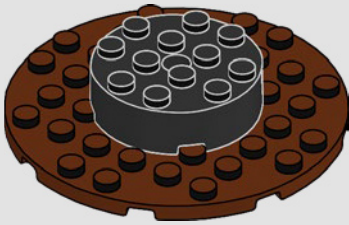

129

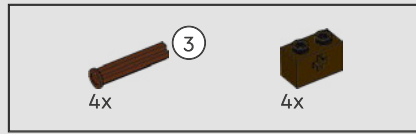
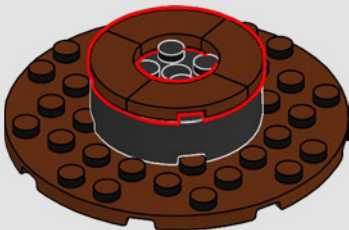

130

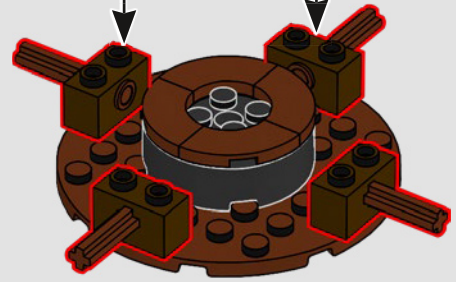
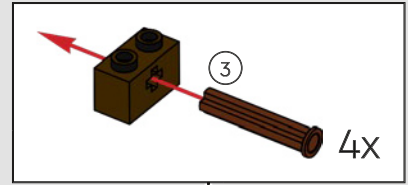

131

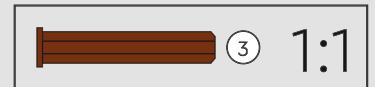
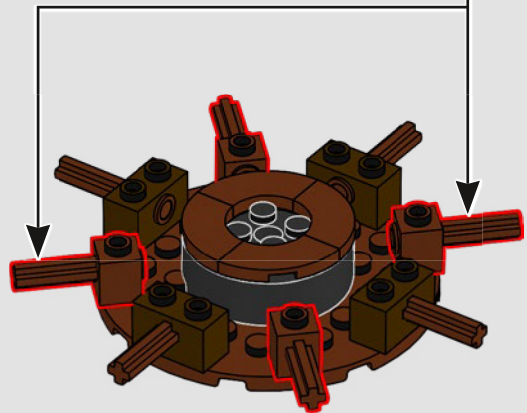
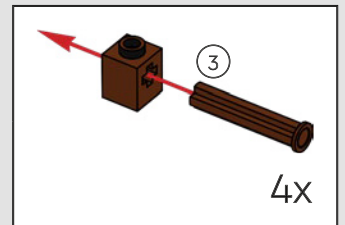

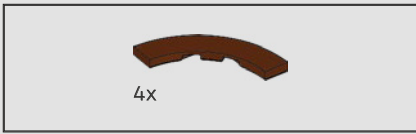

132

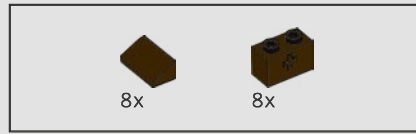
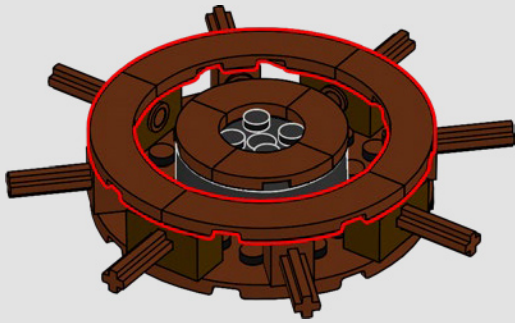

134

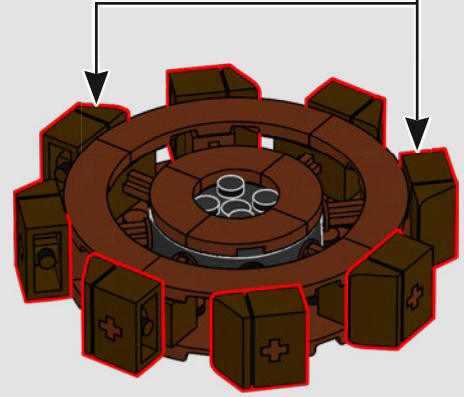
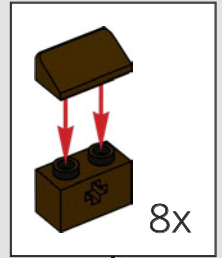

135

133

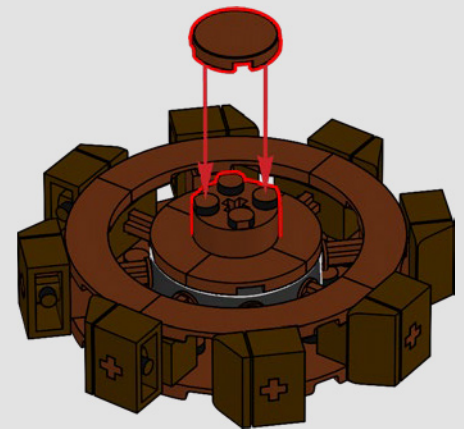
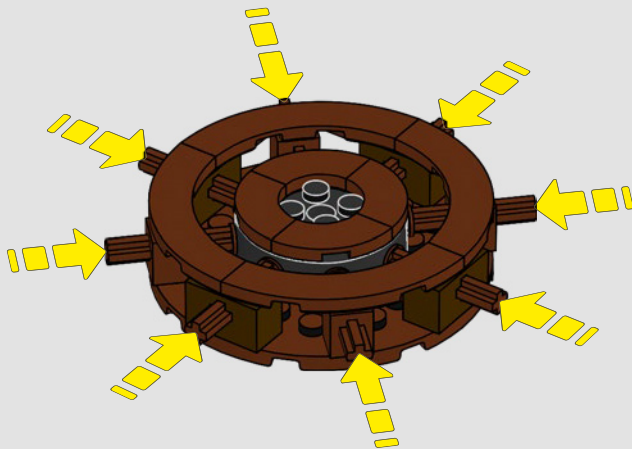

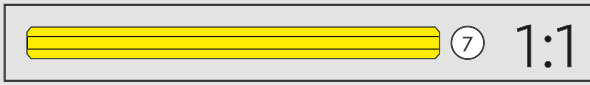
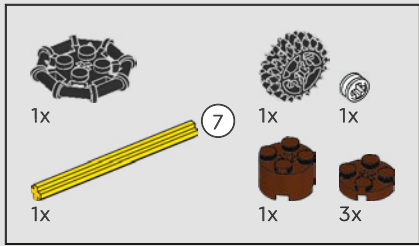

136

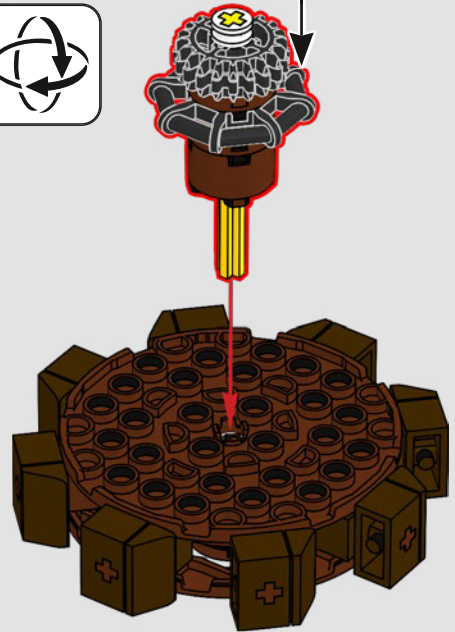
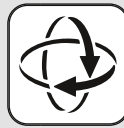
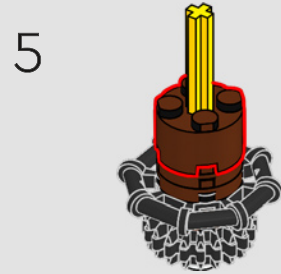
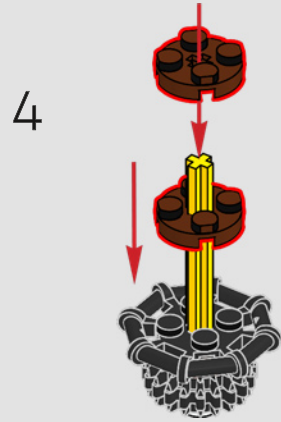
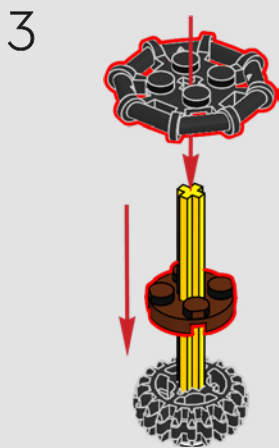
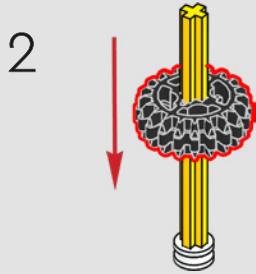
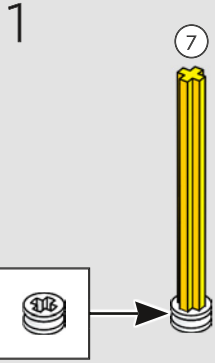



La potencia de esta rueda hidráulica es enorme.
¡Es ideal para impulsar el molino!

137

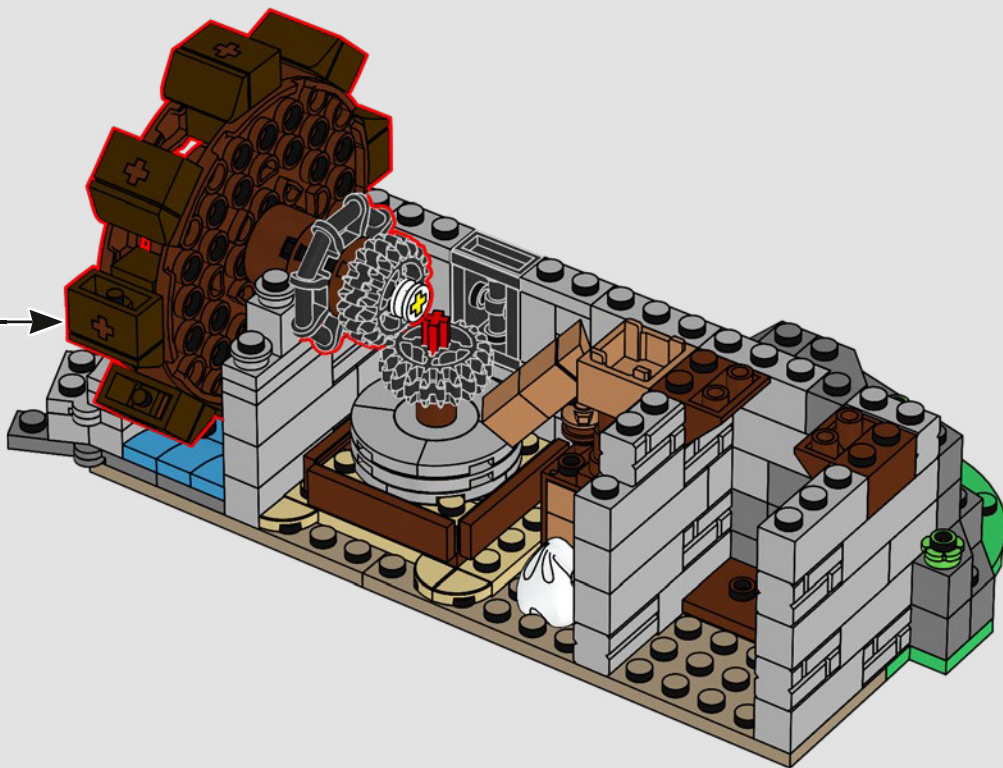

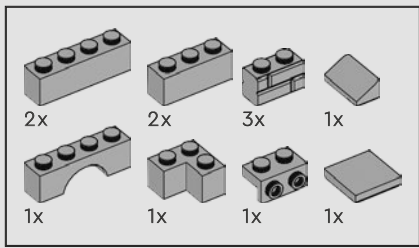

138

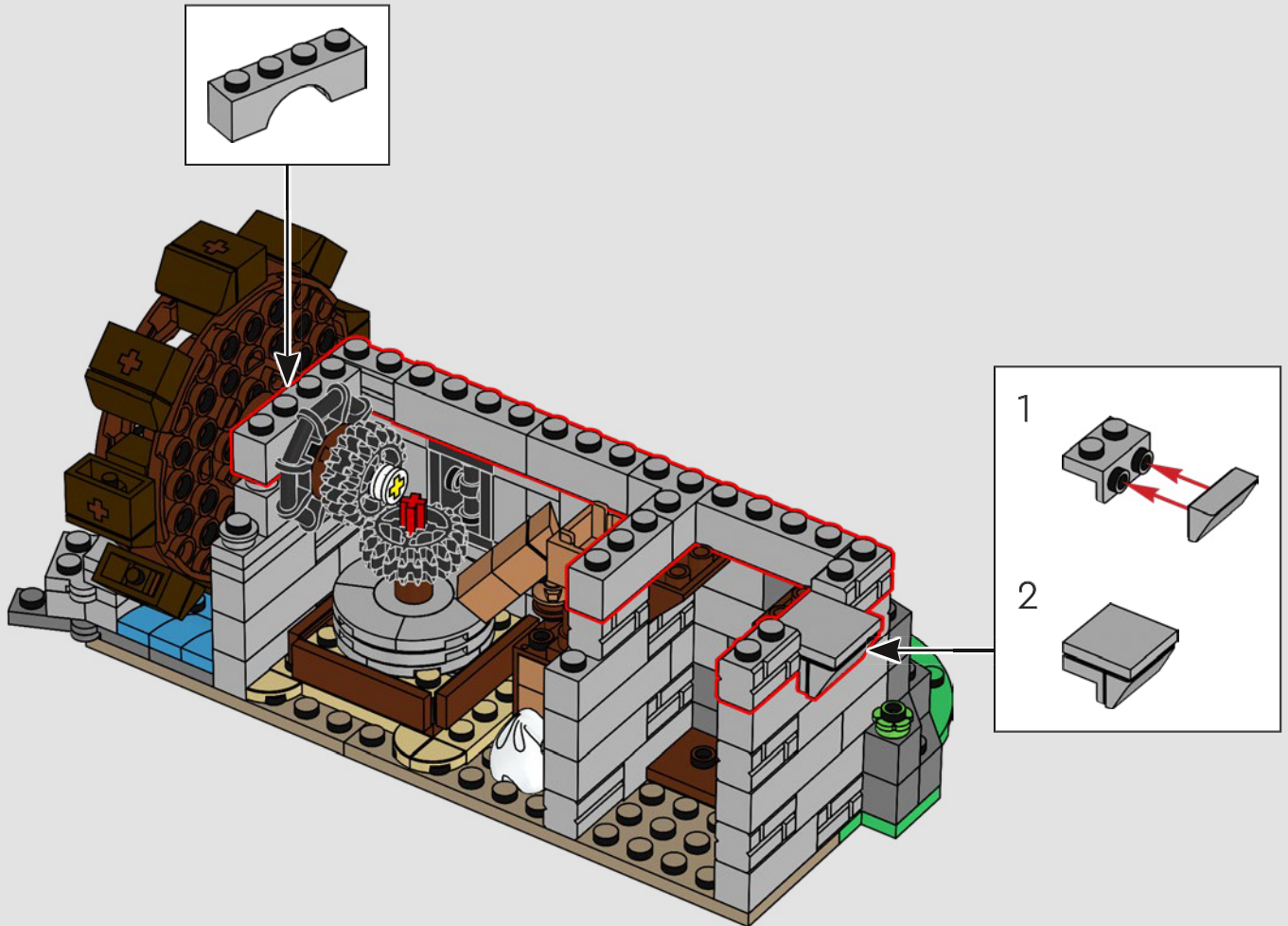



¡Un nido de aves!

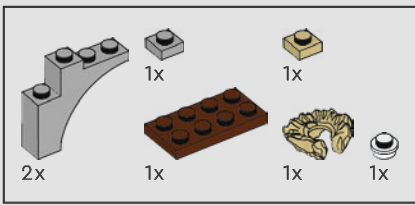

139

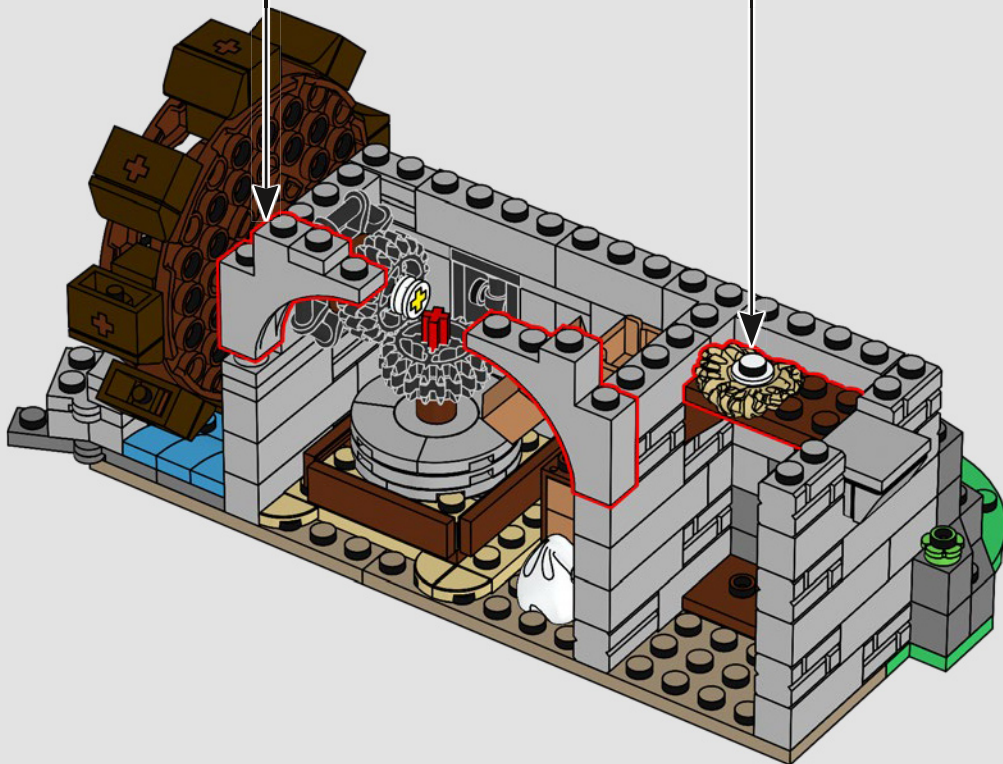
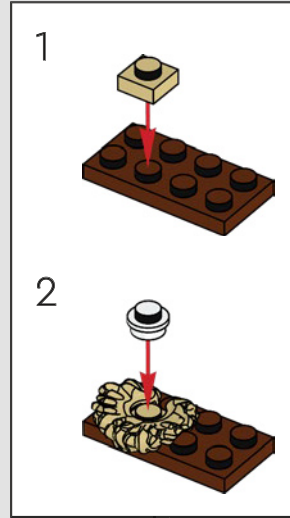
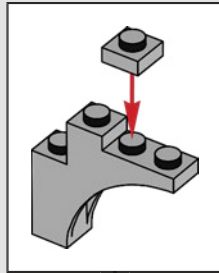

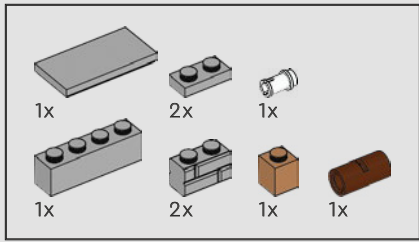

140

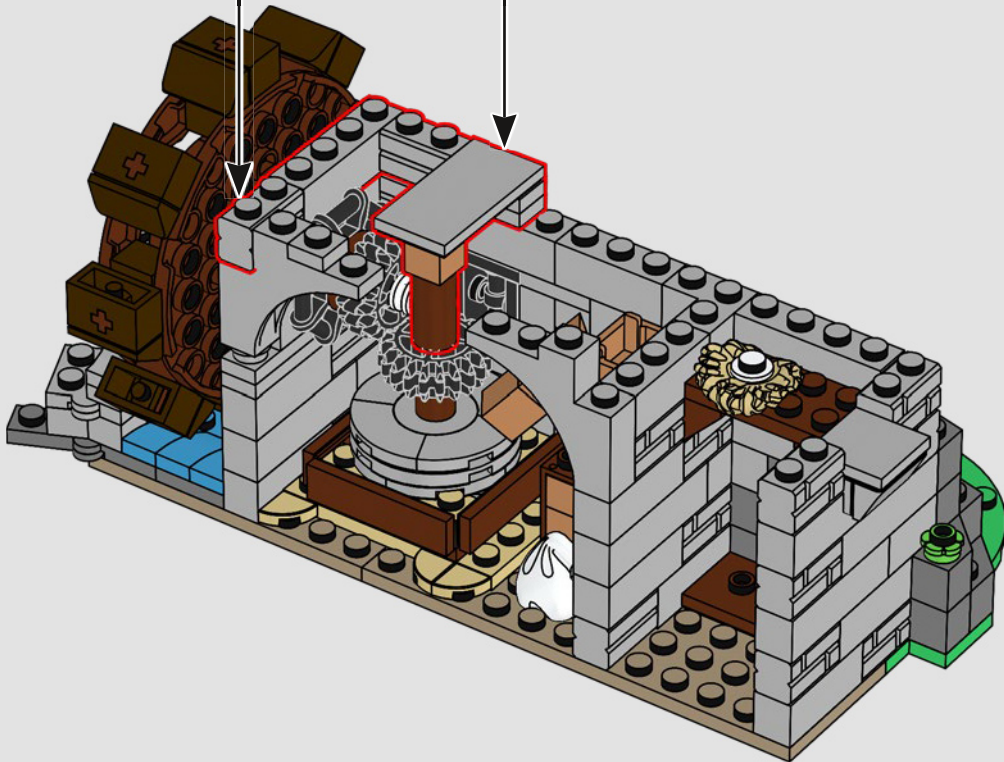
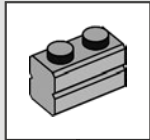
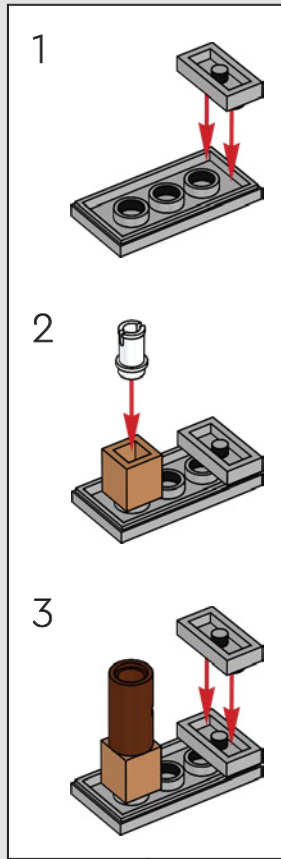

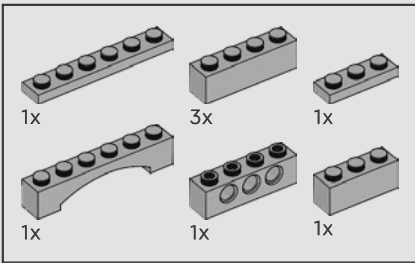

141

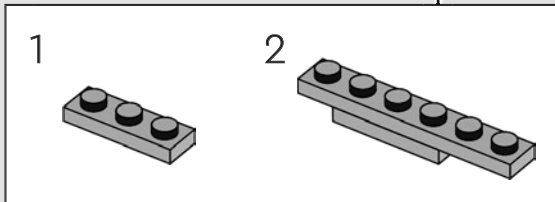
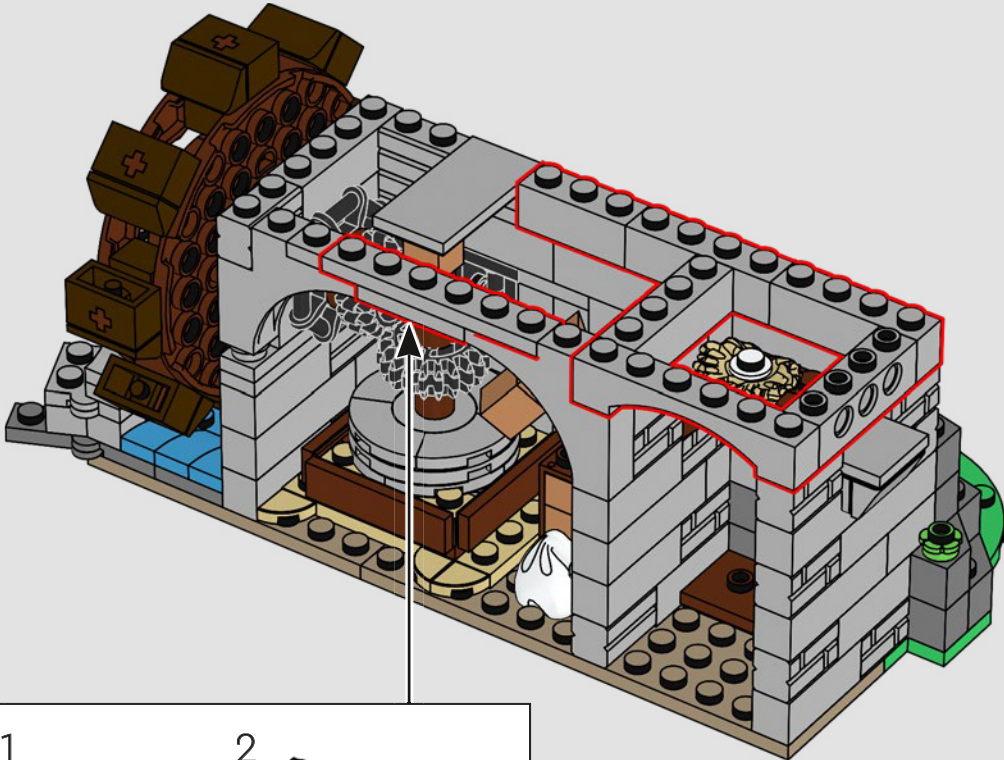

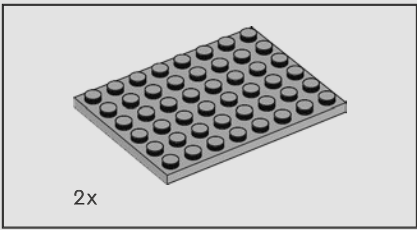

142

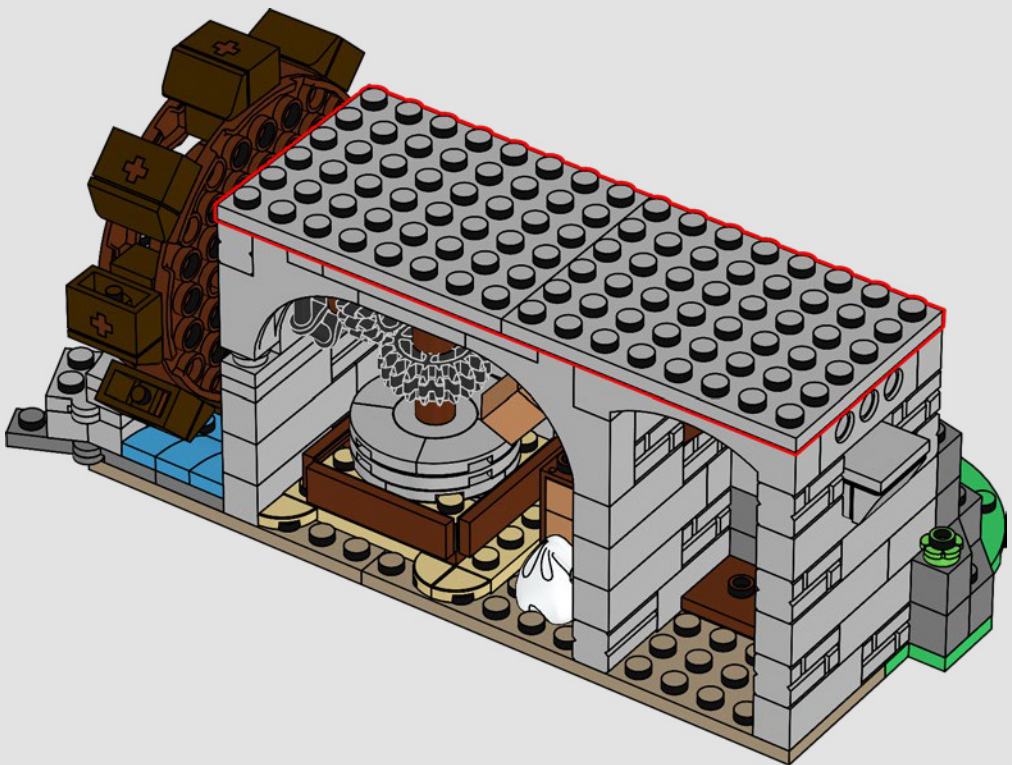

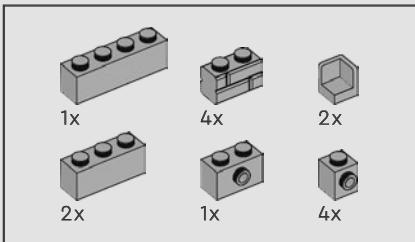

143

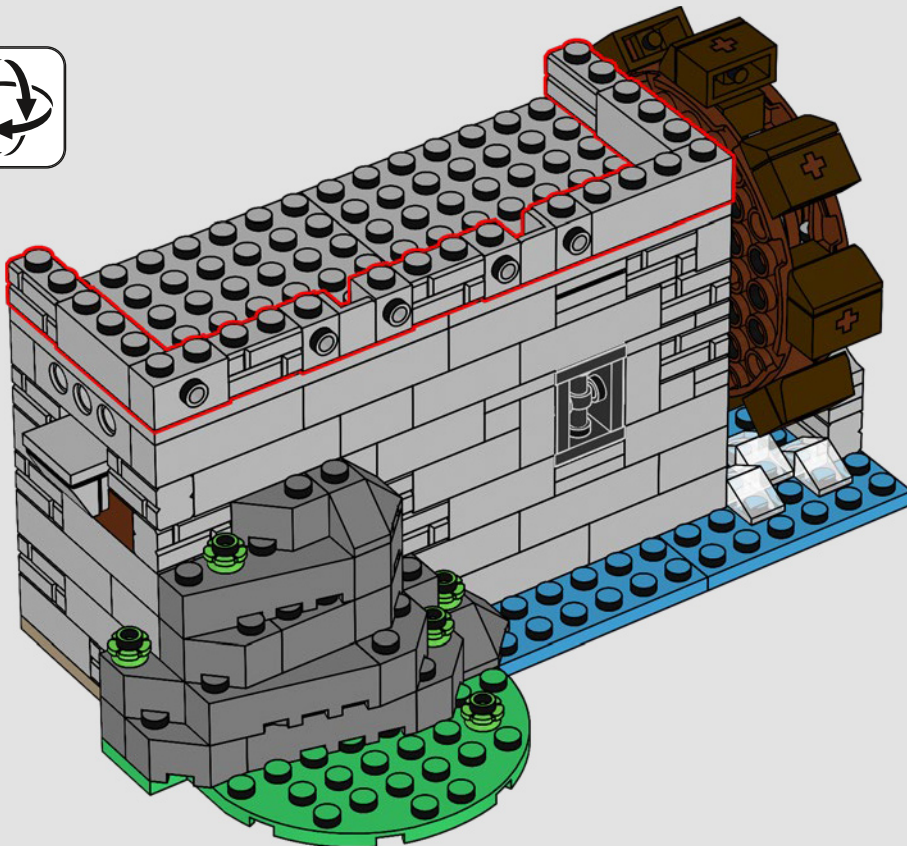

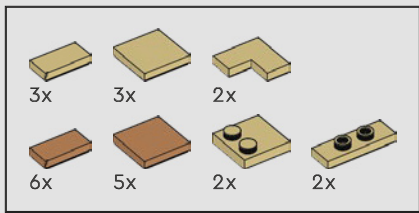

144

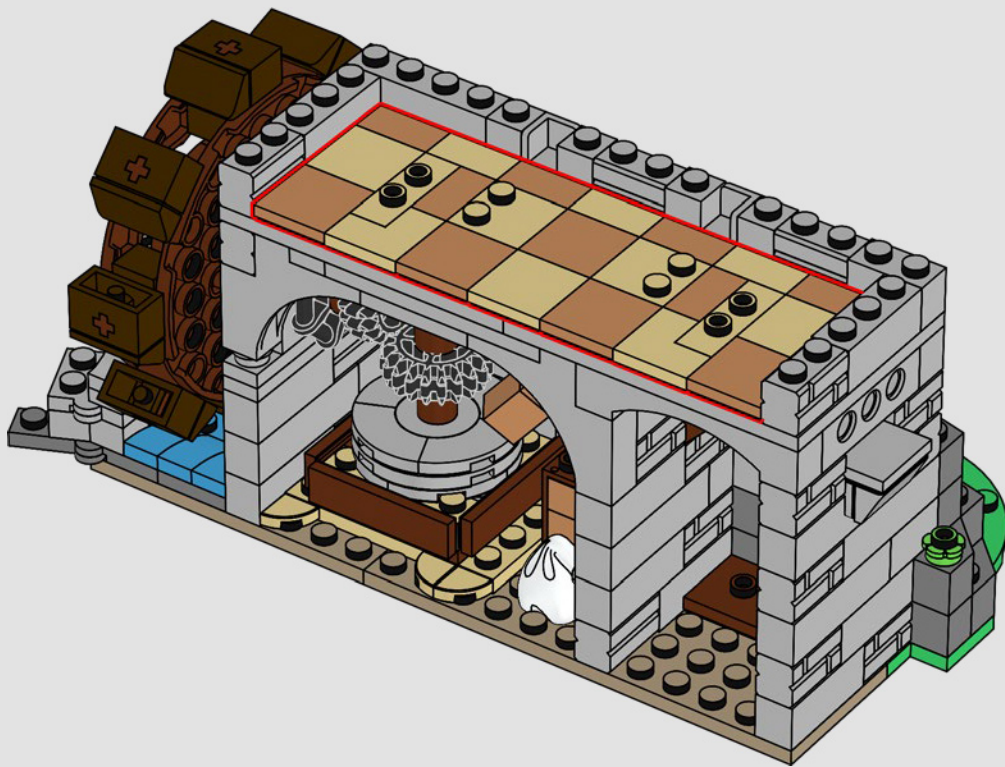

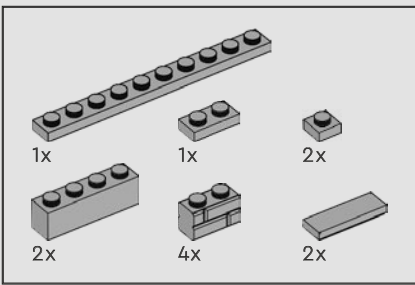

145

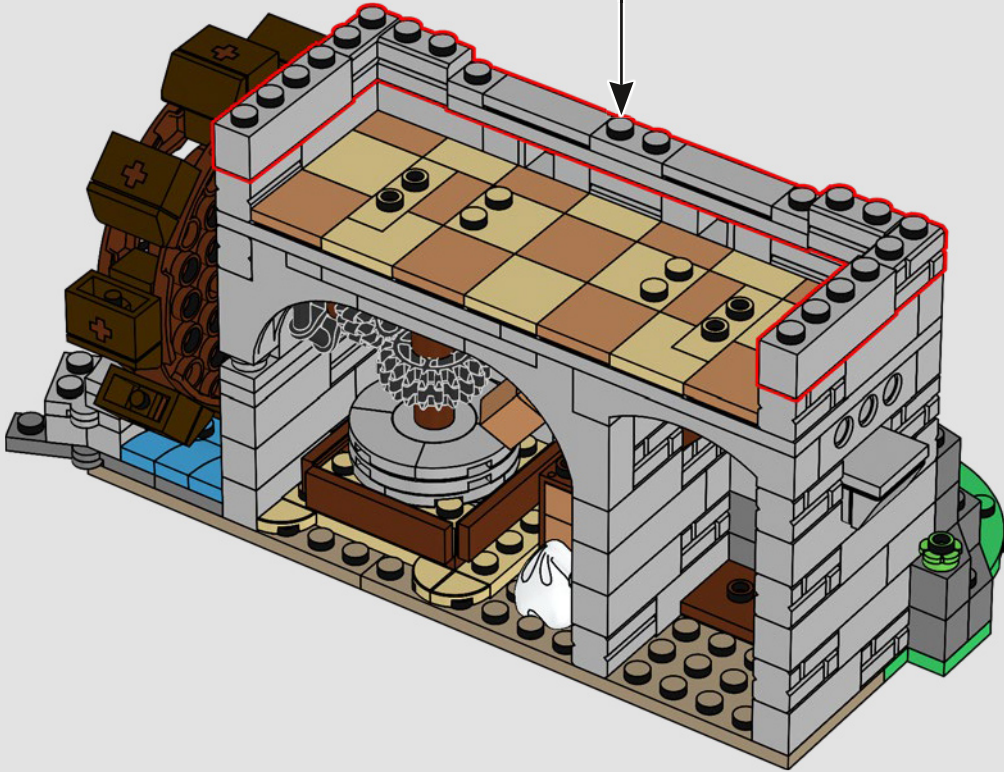
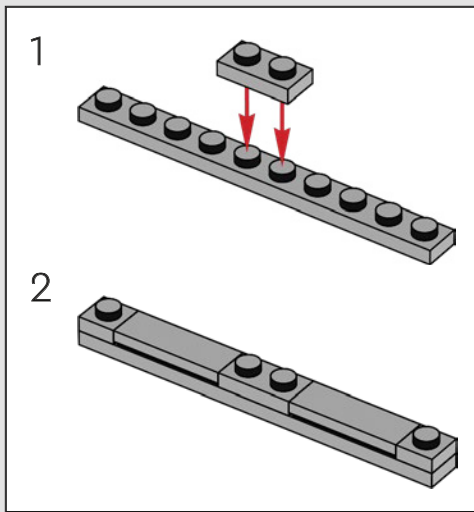

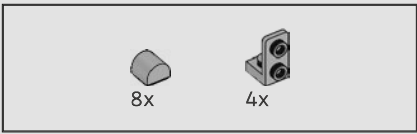

146

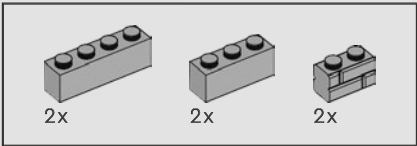
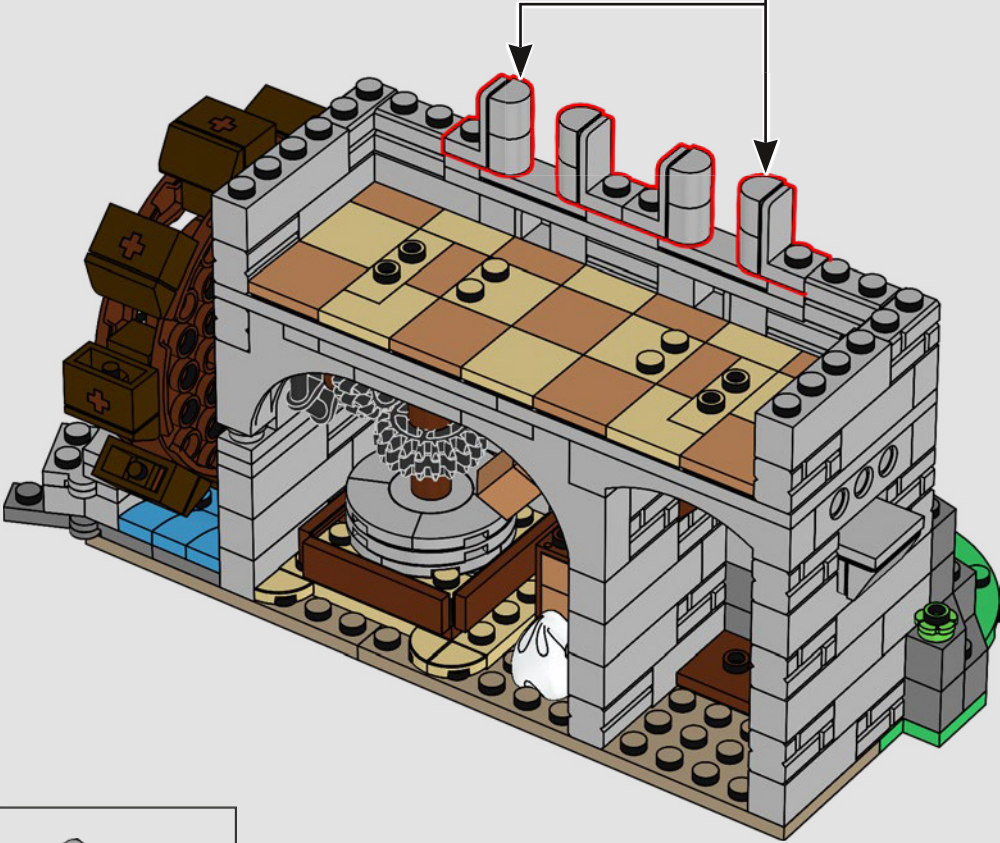
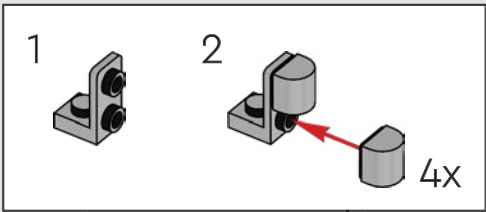

147

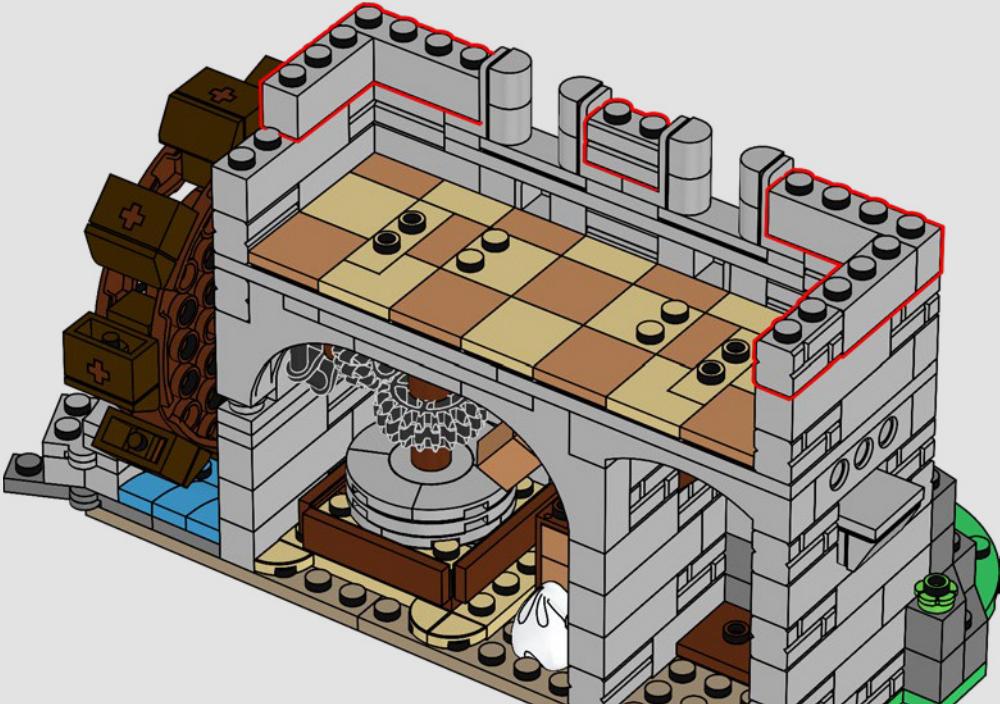

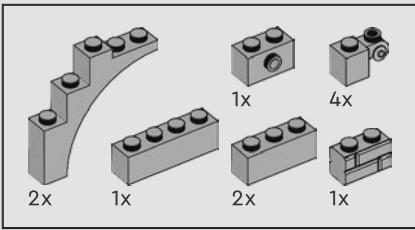

148

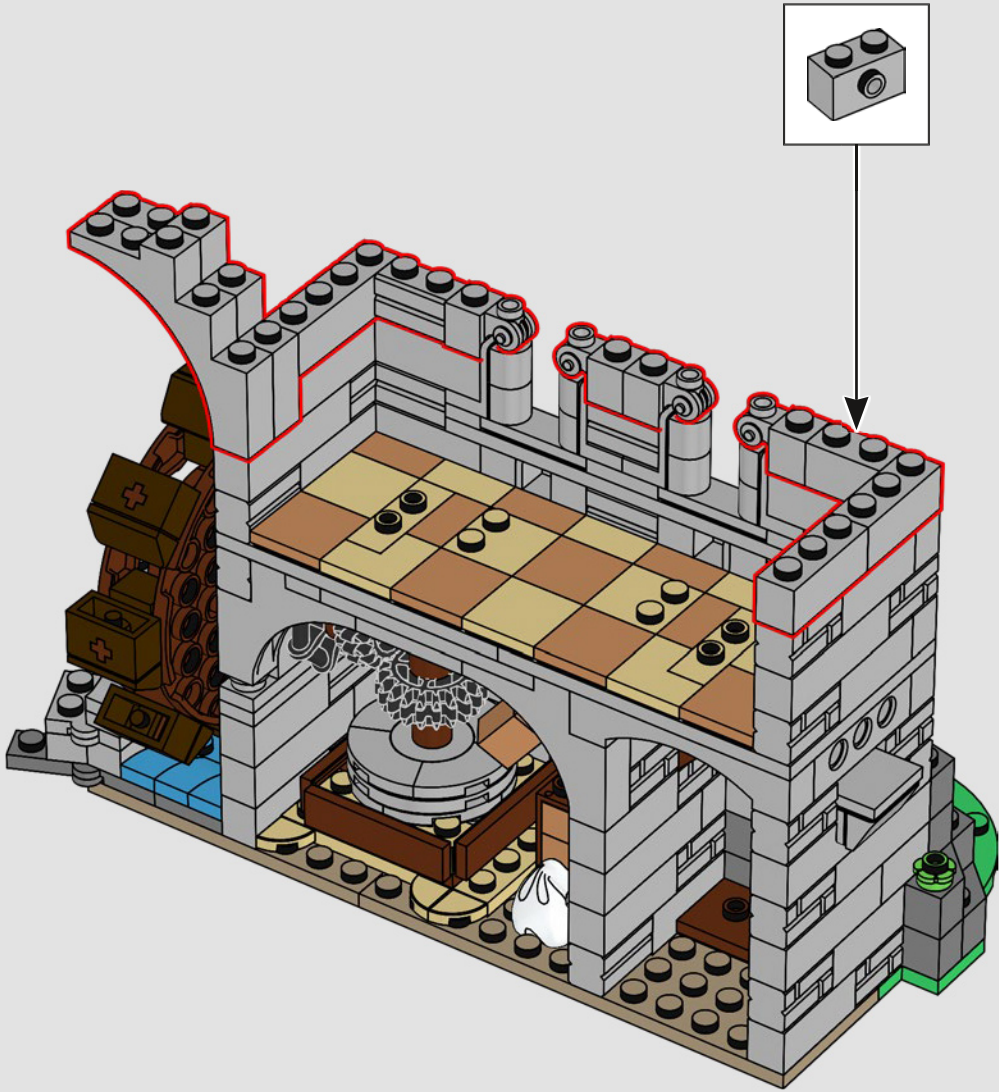

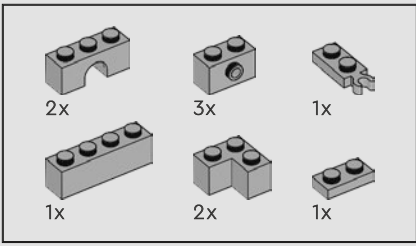

149

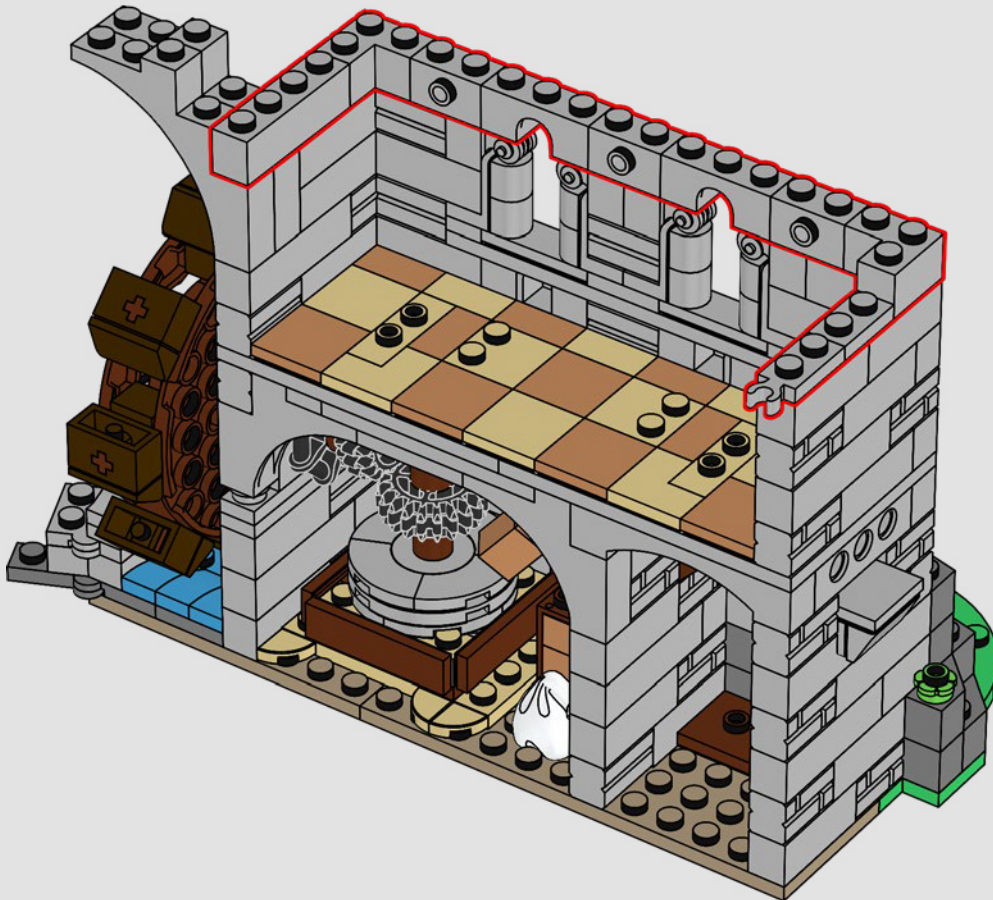

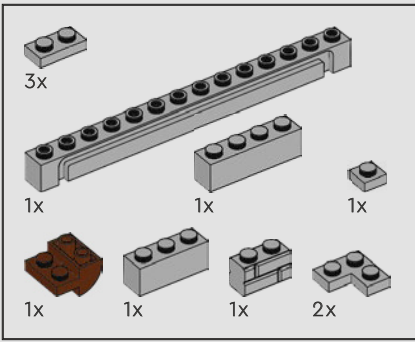

150

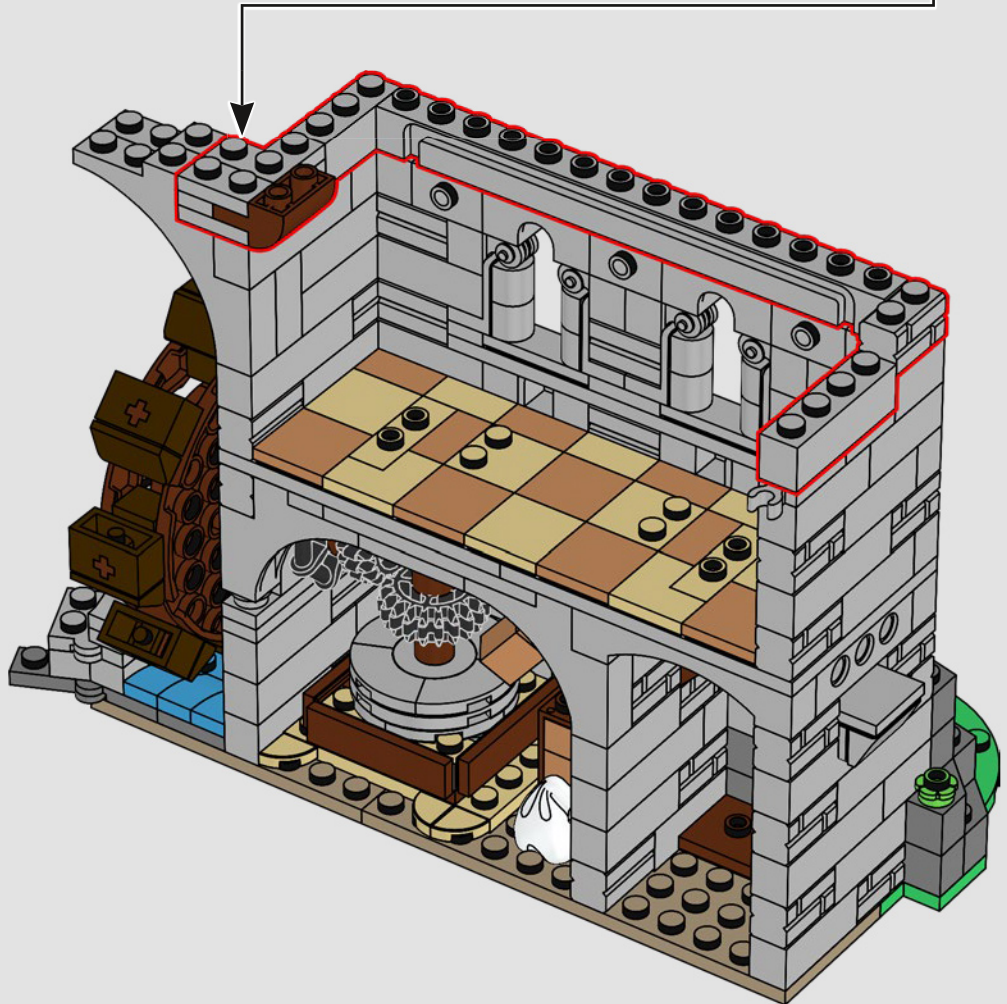
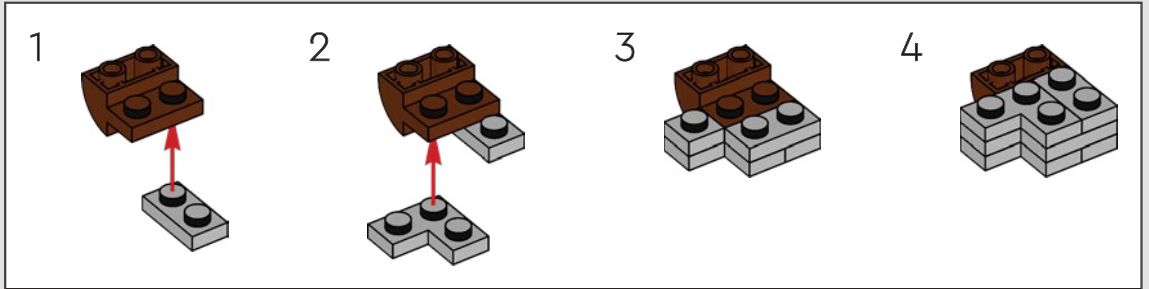

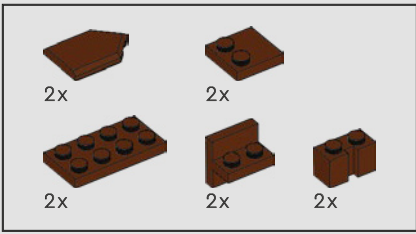

151

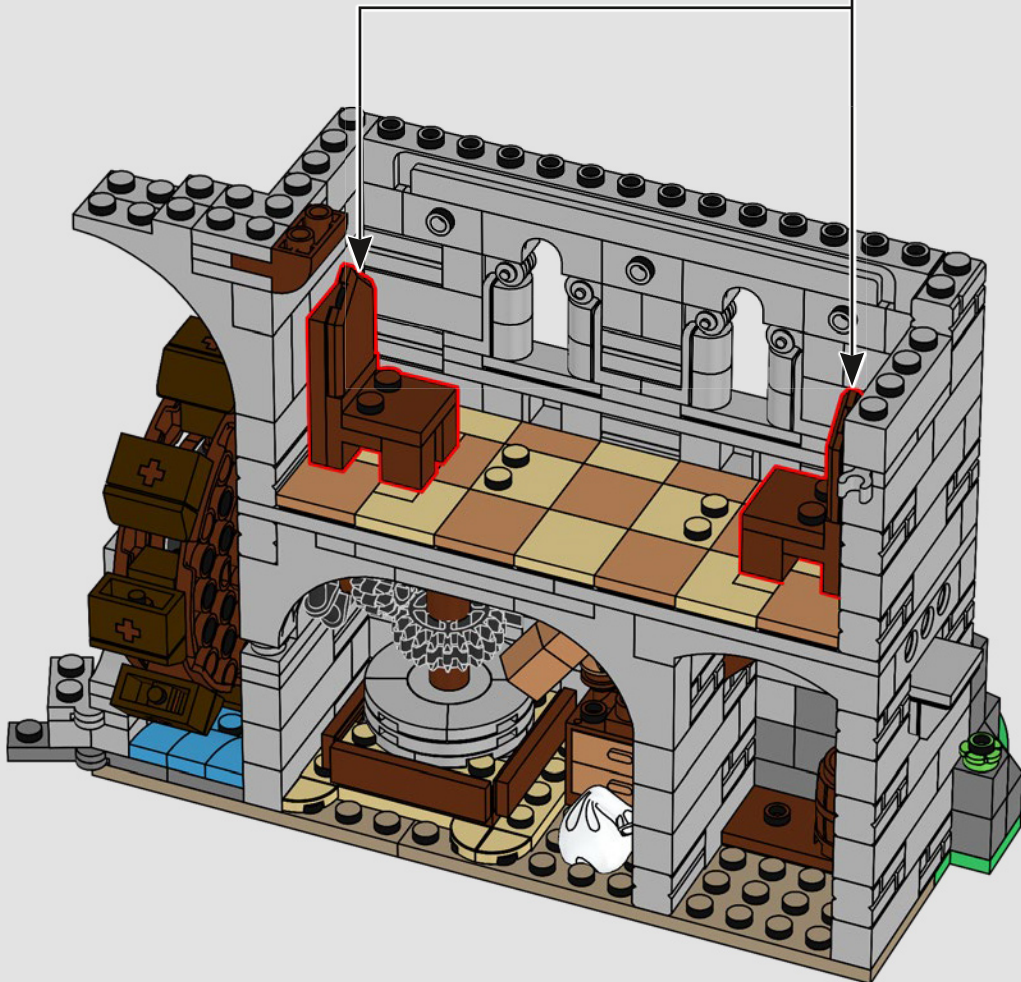
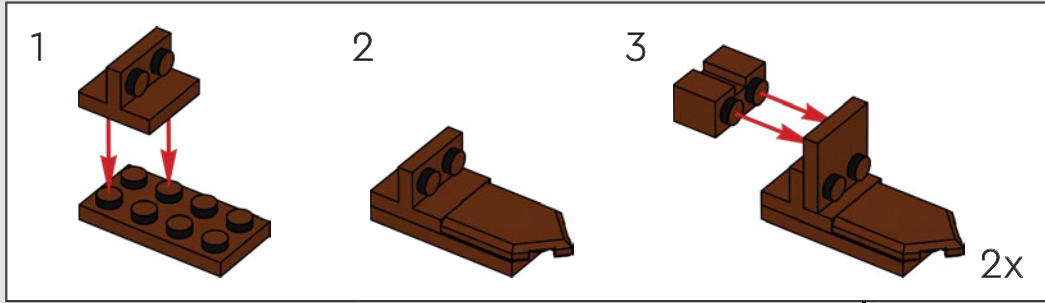



La mesa está lista, pero ¿dónde están los manjares?

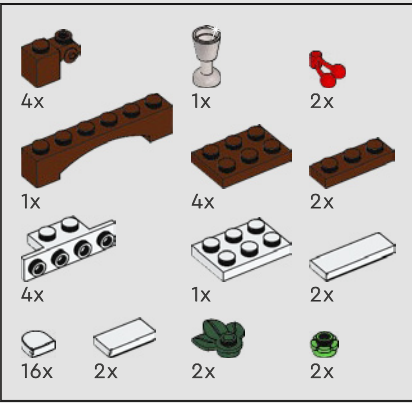
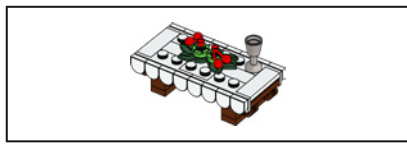

152

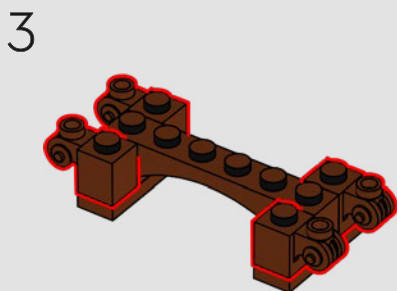
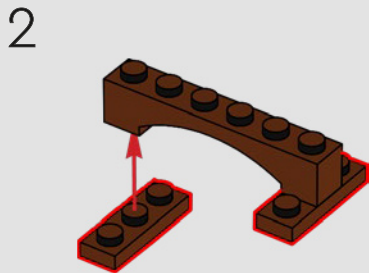
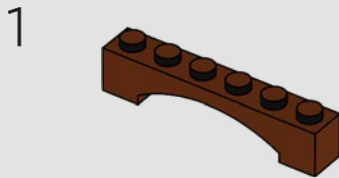

4

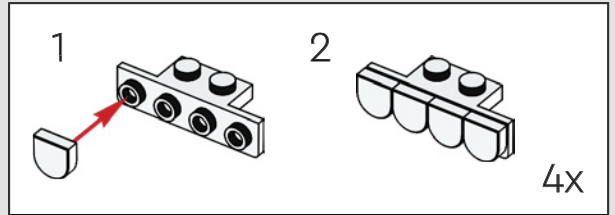
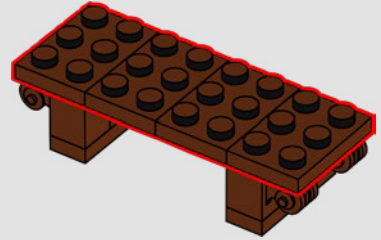

5

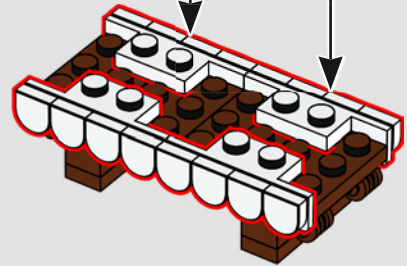

6

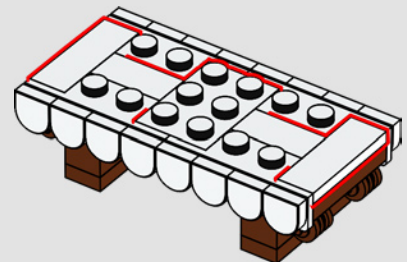

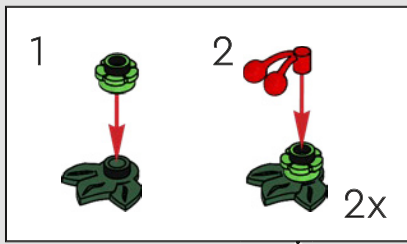

7

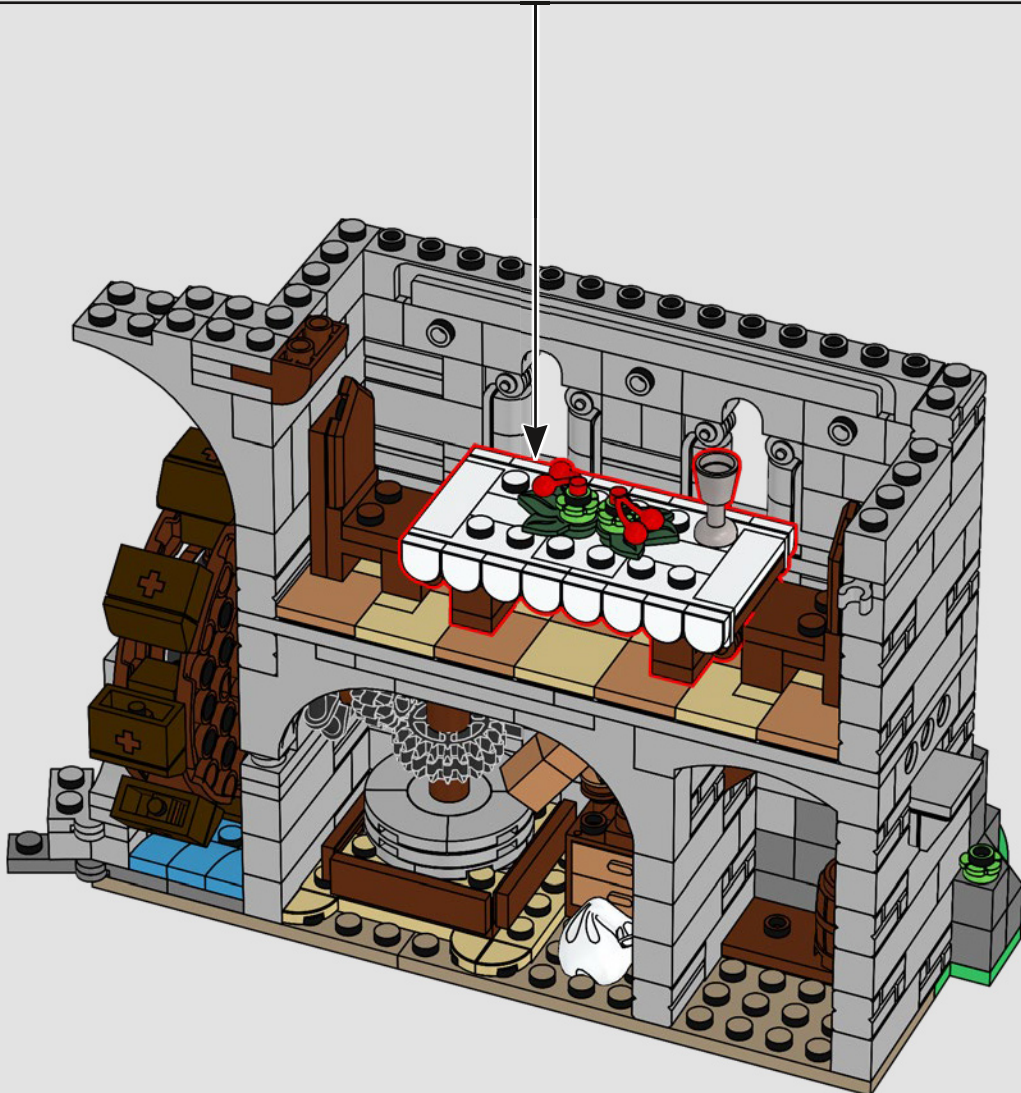
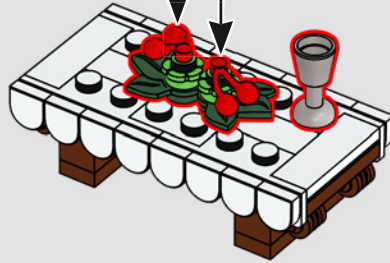



*Qué tonalidad de rosa tan encantadora.
Ese heraldo de antaño trae memorias de
tiempos menos tormentosos...*

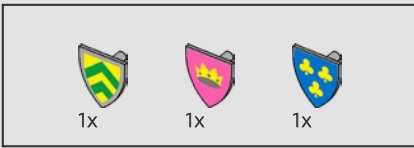

153



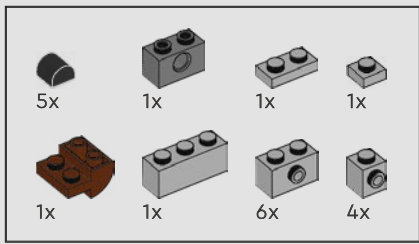

154

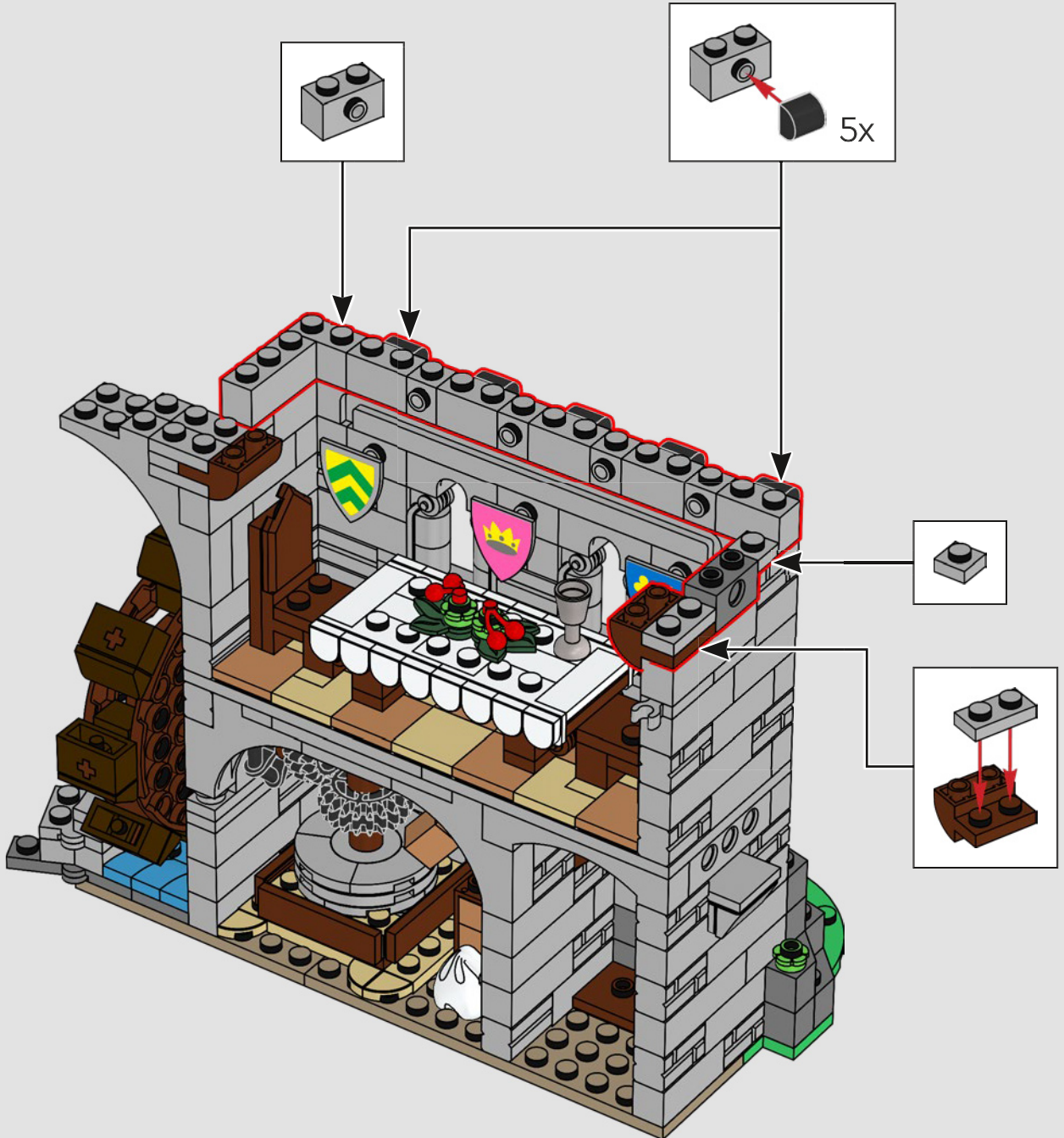

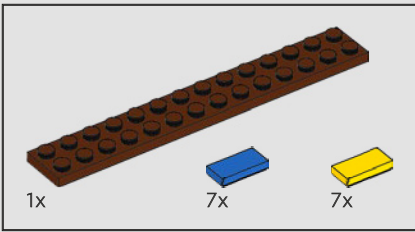

155

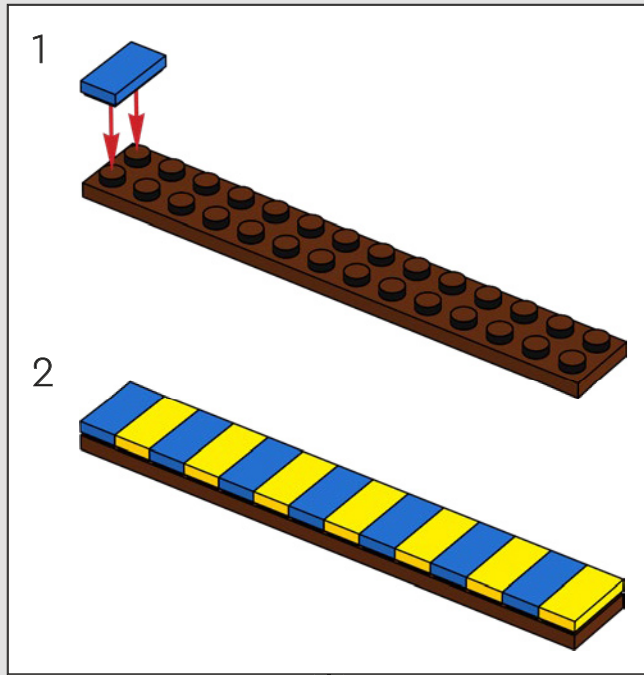

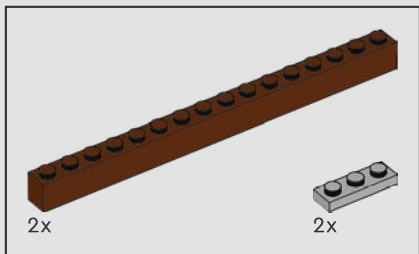

156

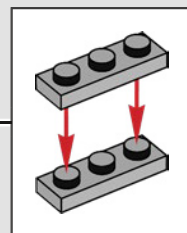

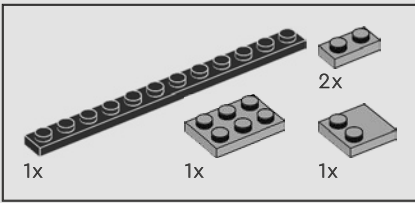

157

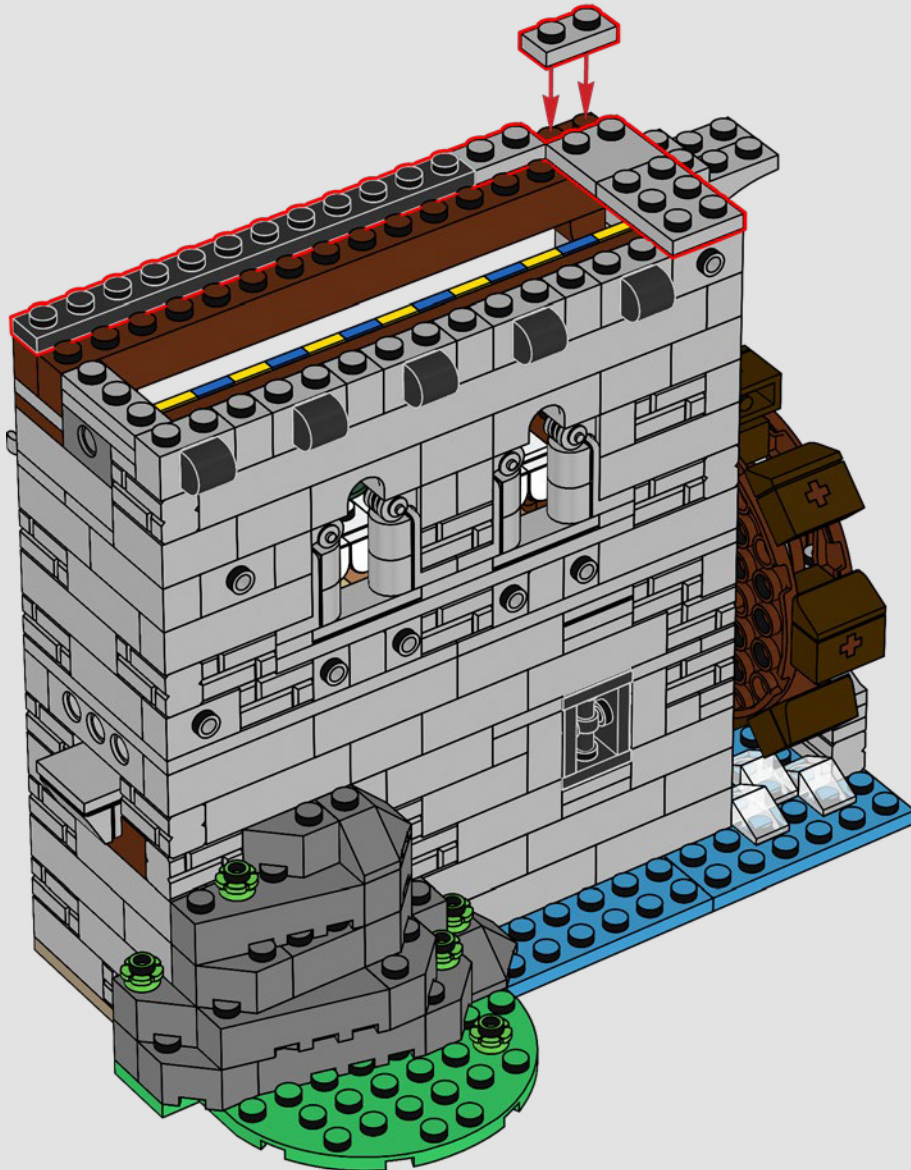

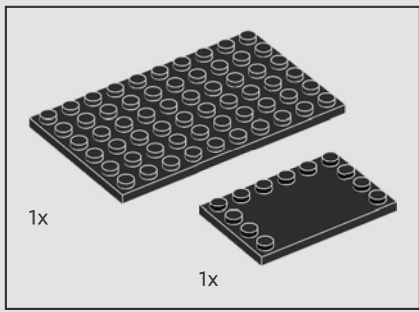

158

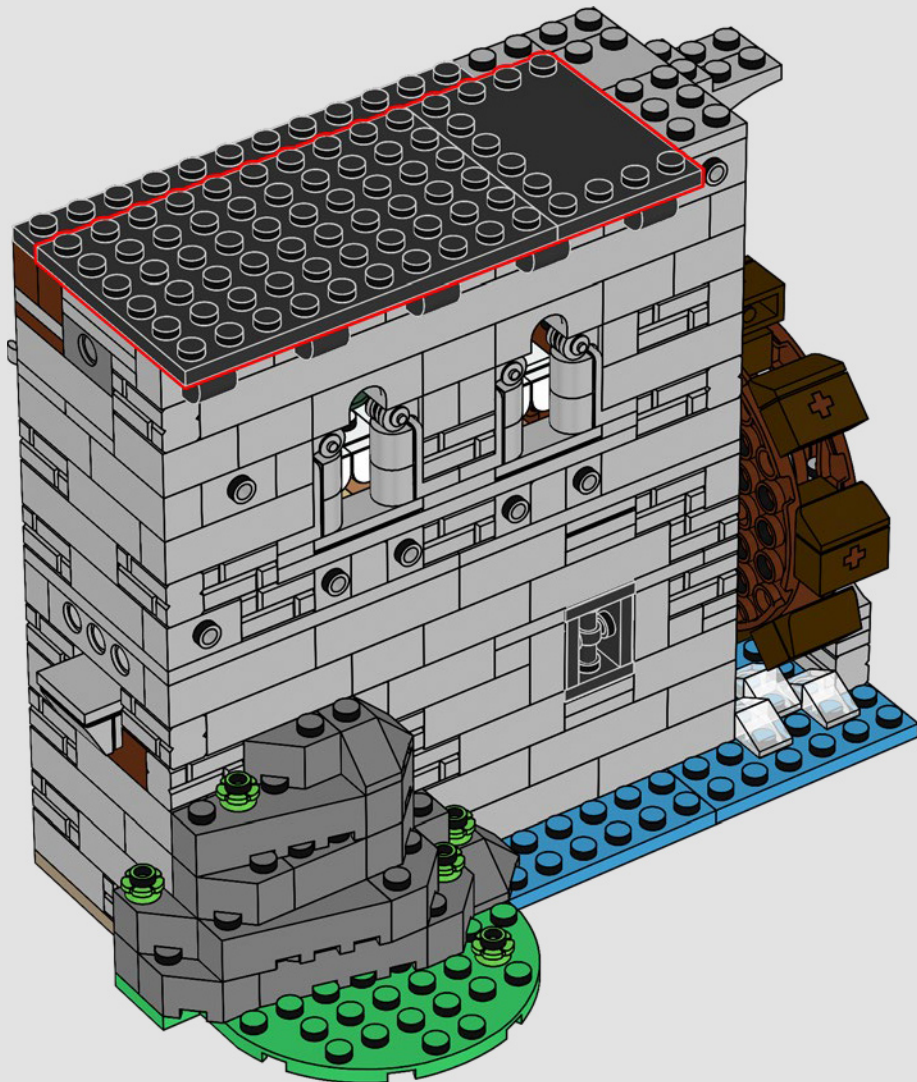



159

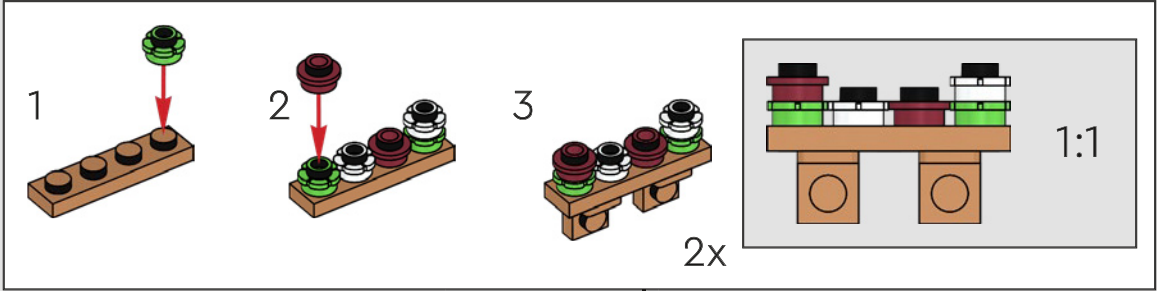

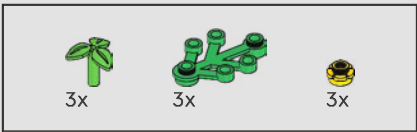

160

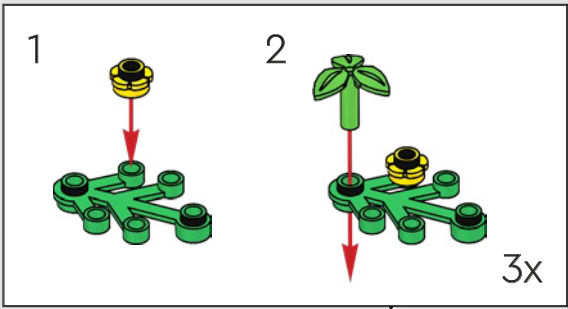

161



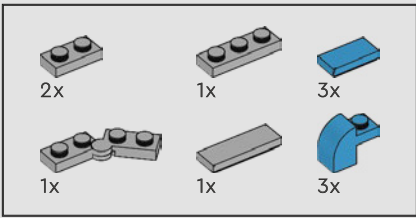

162

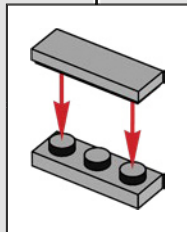
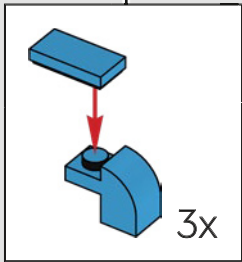
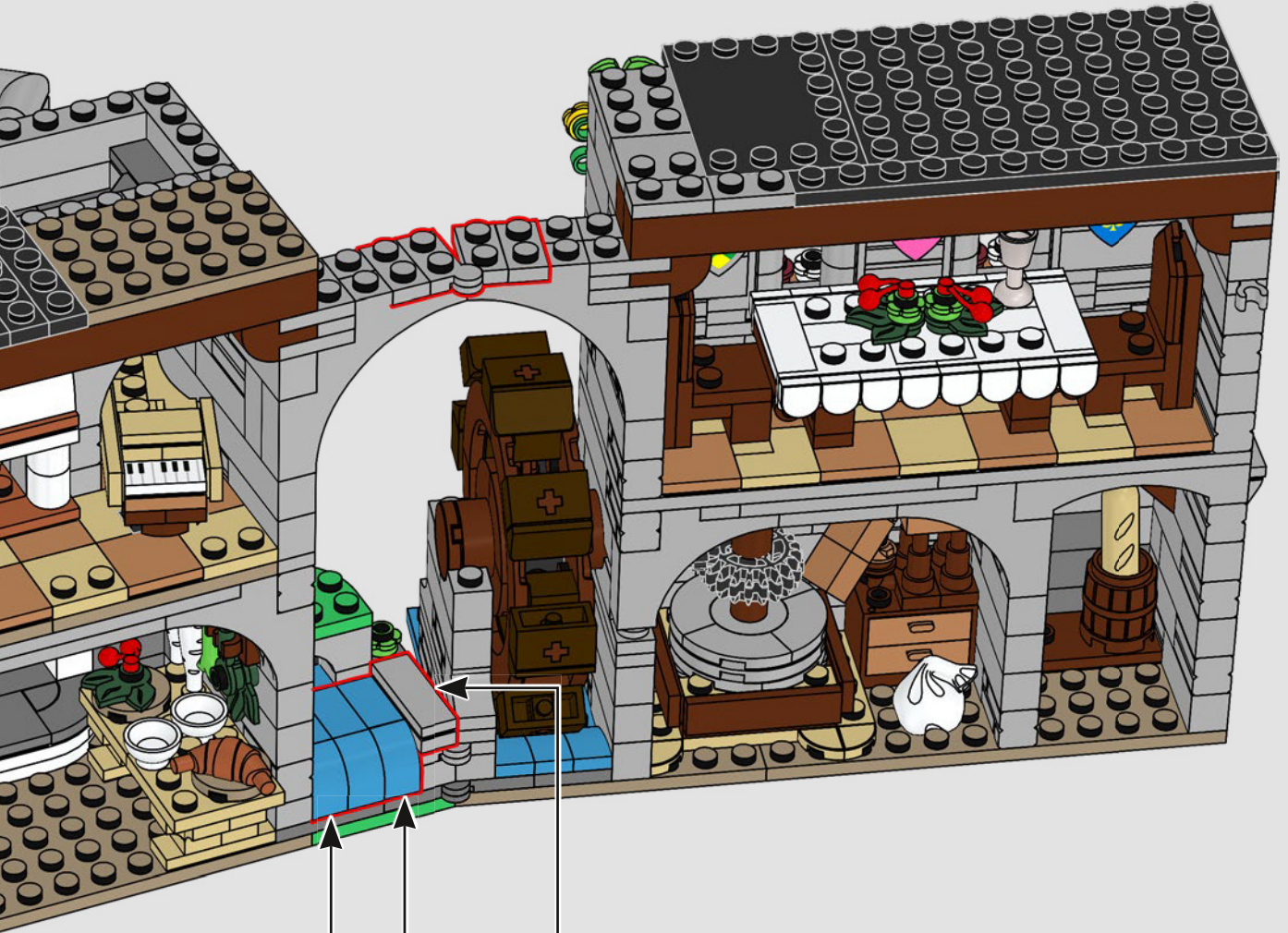

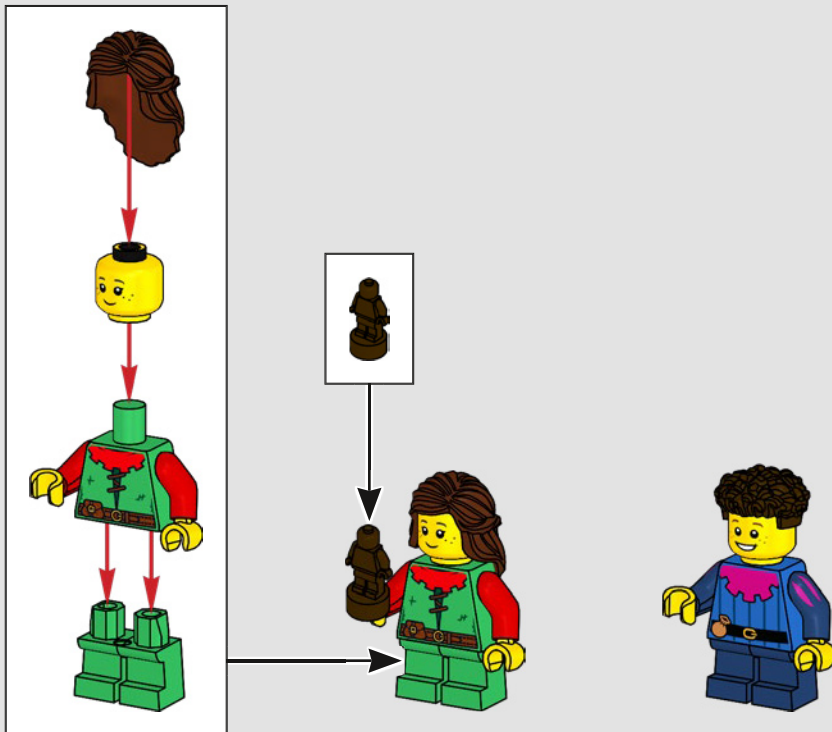

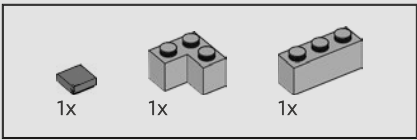

163

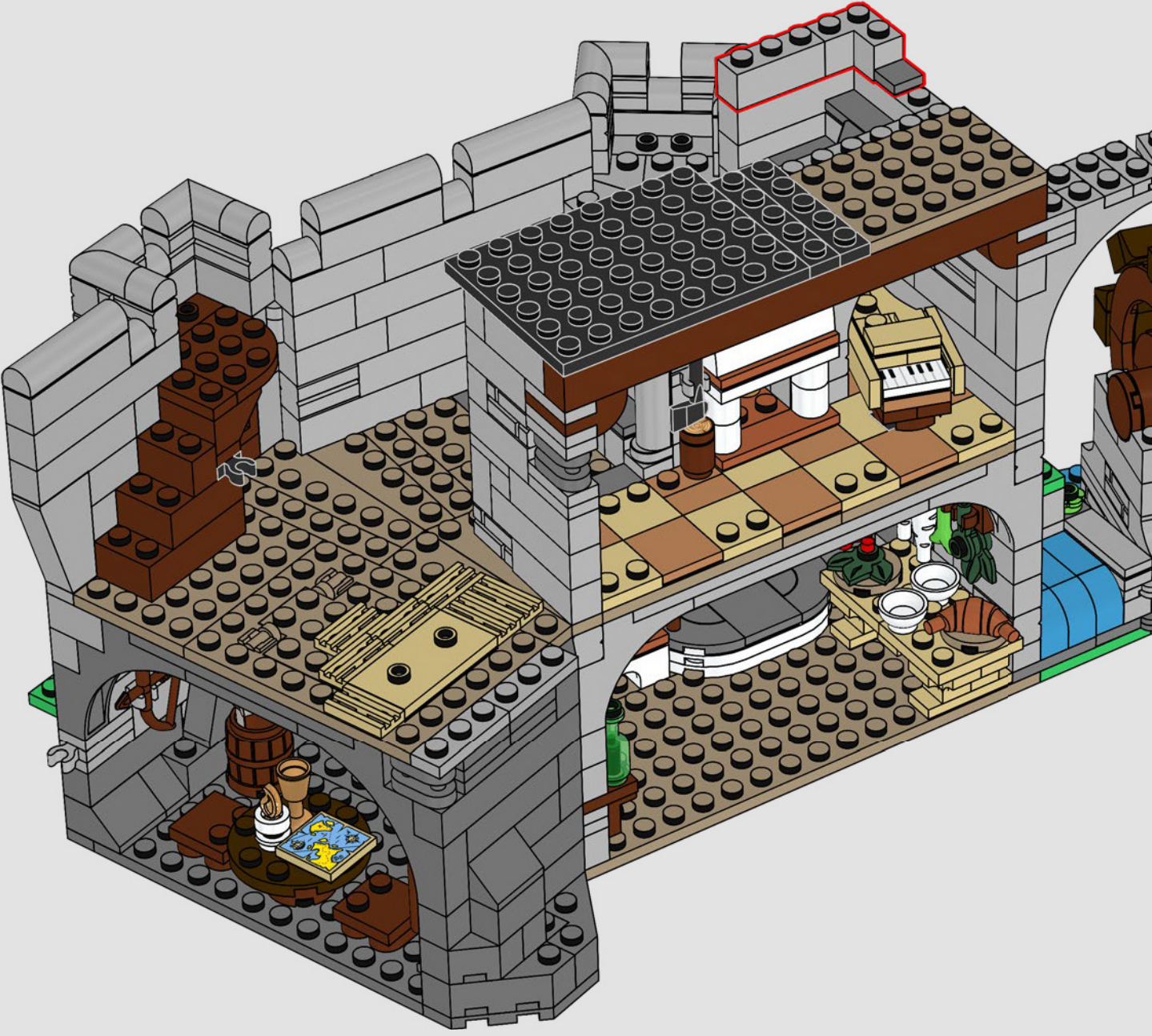

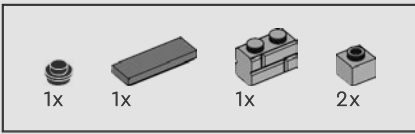

164

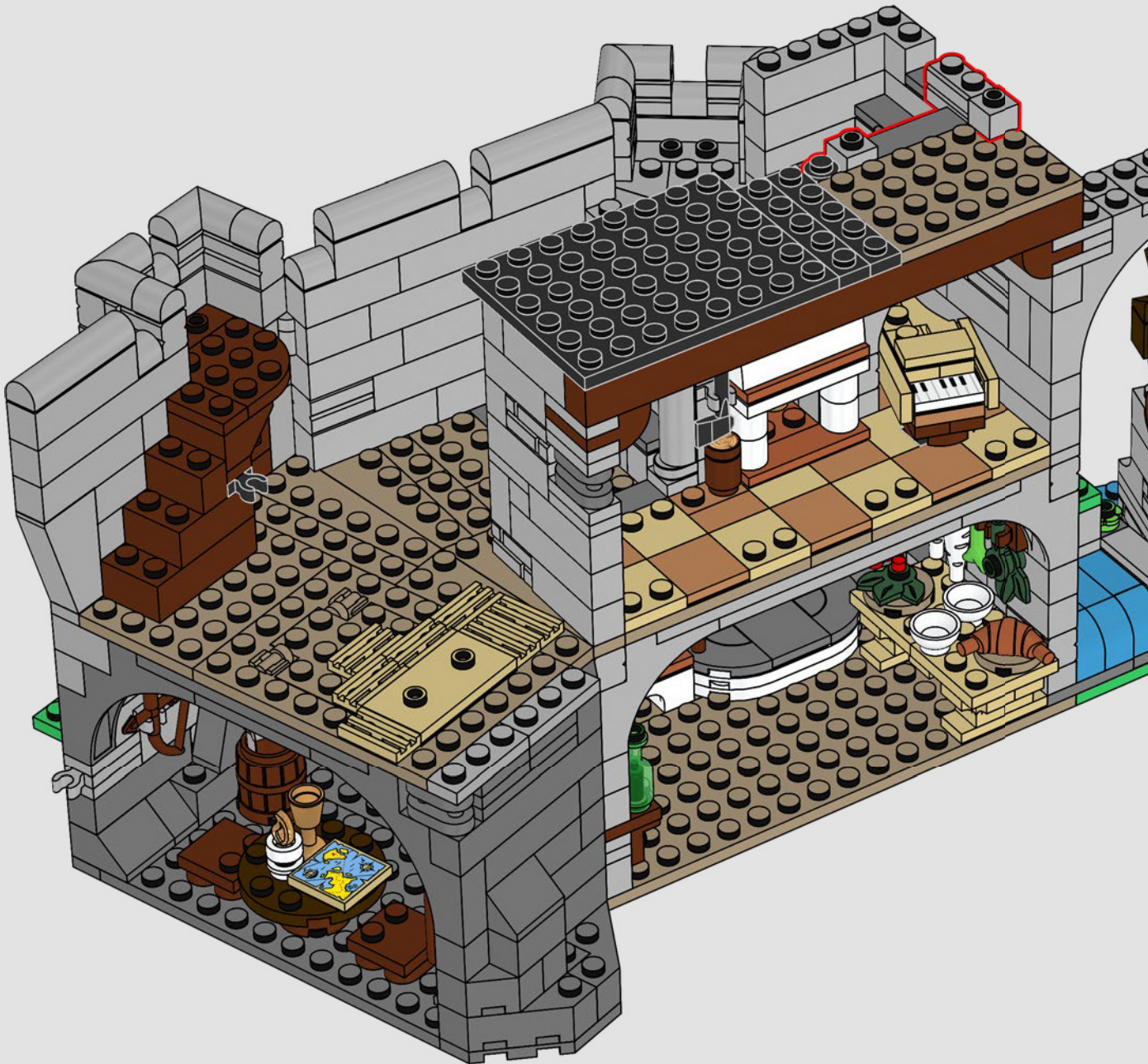

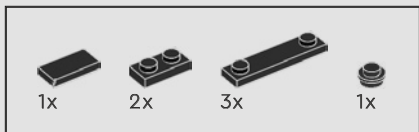

165



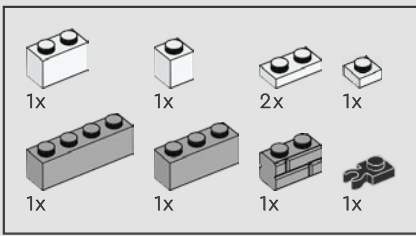

166

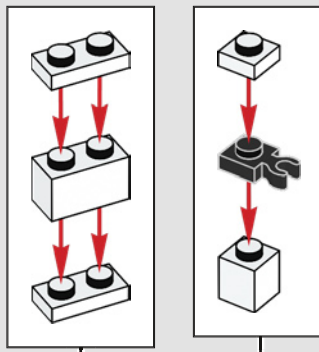

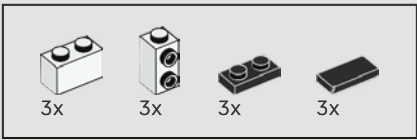

167

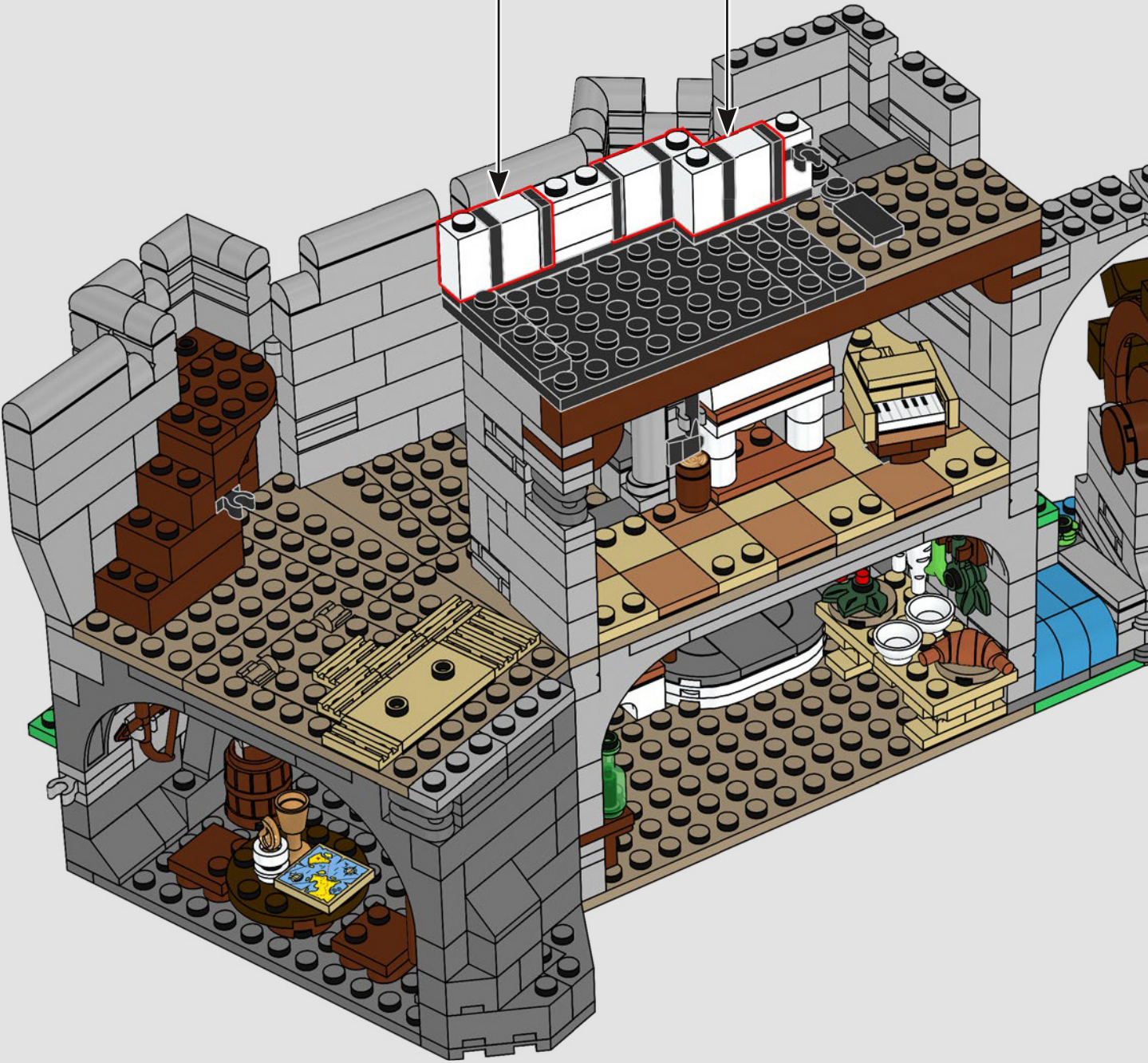
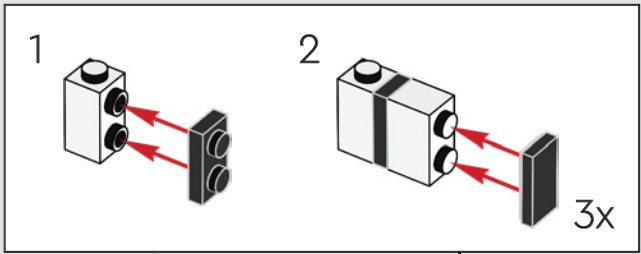

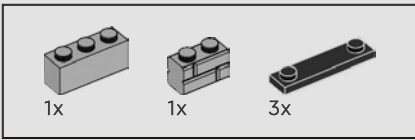

168

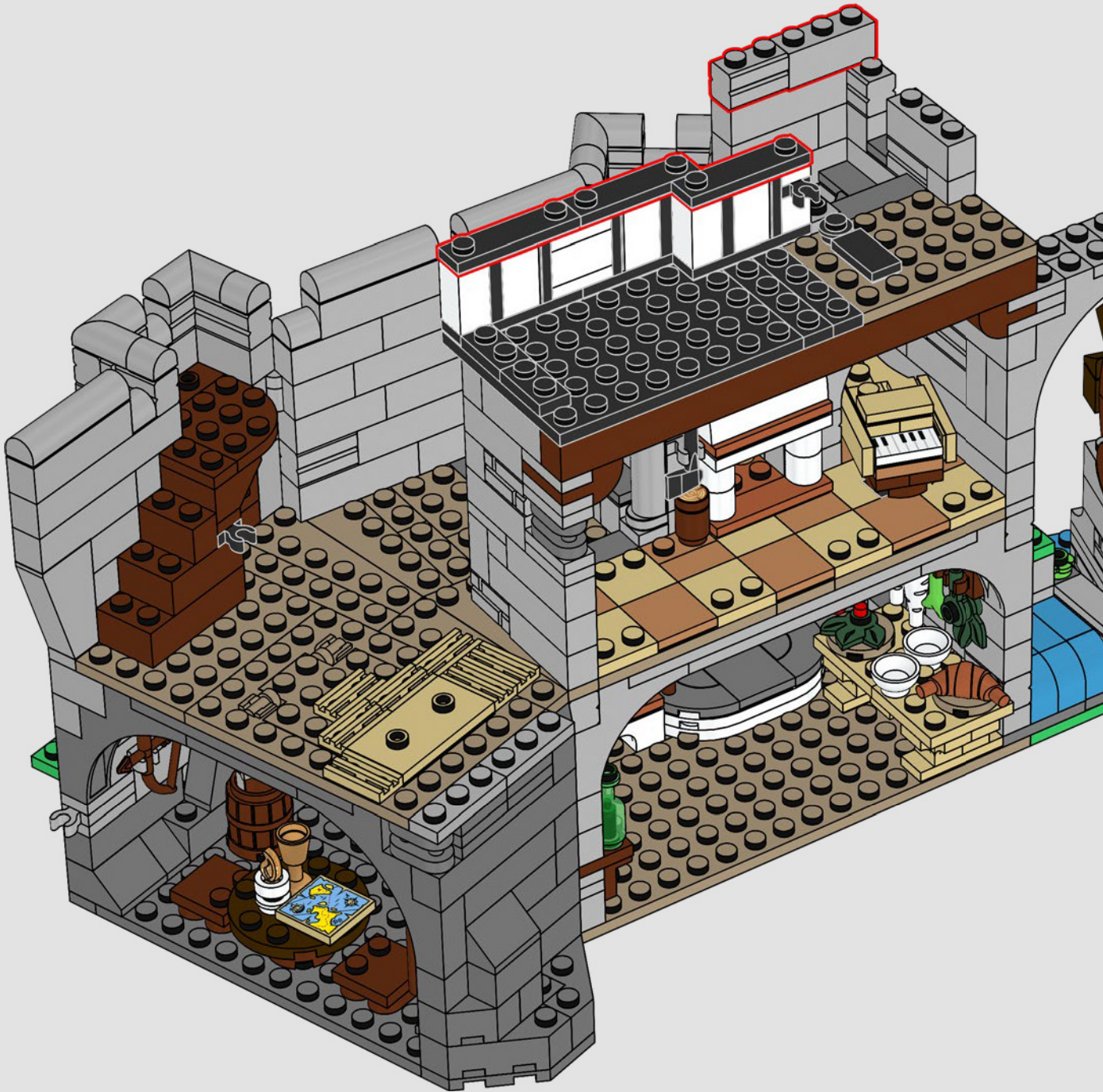

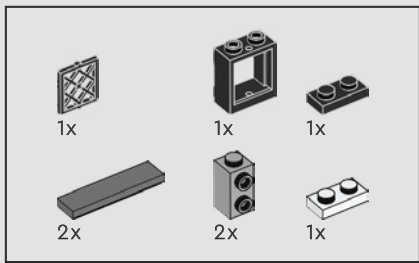

169

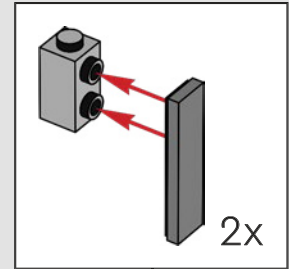
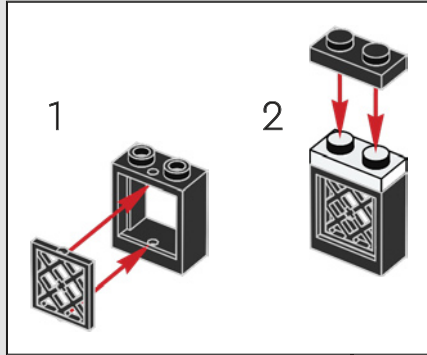

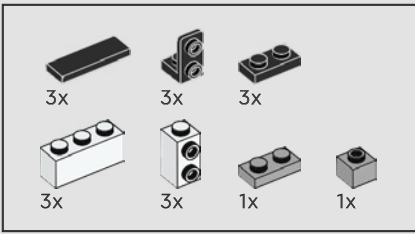

170

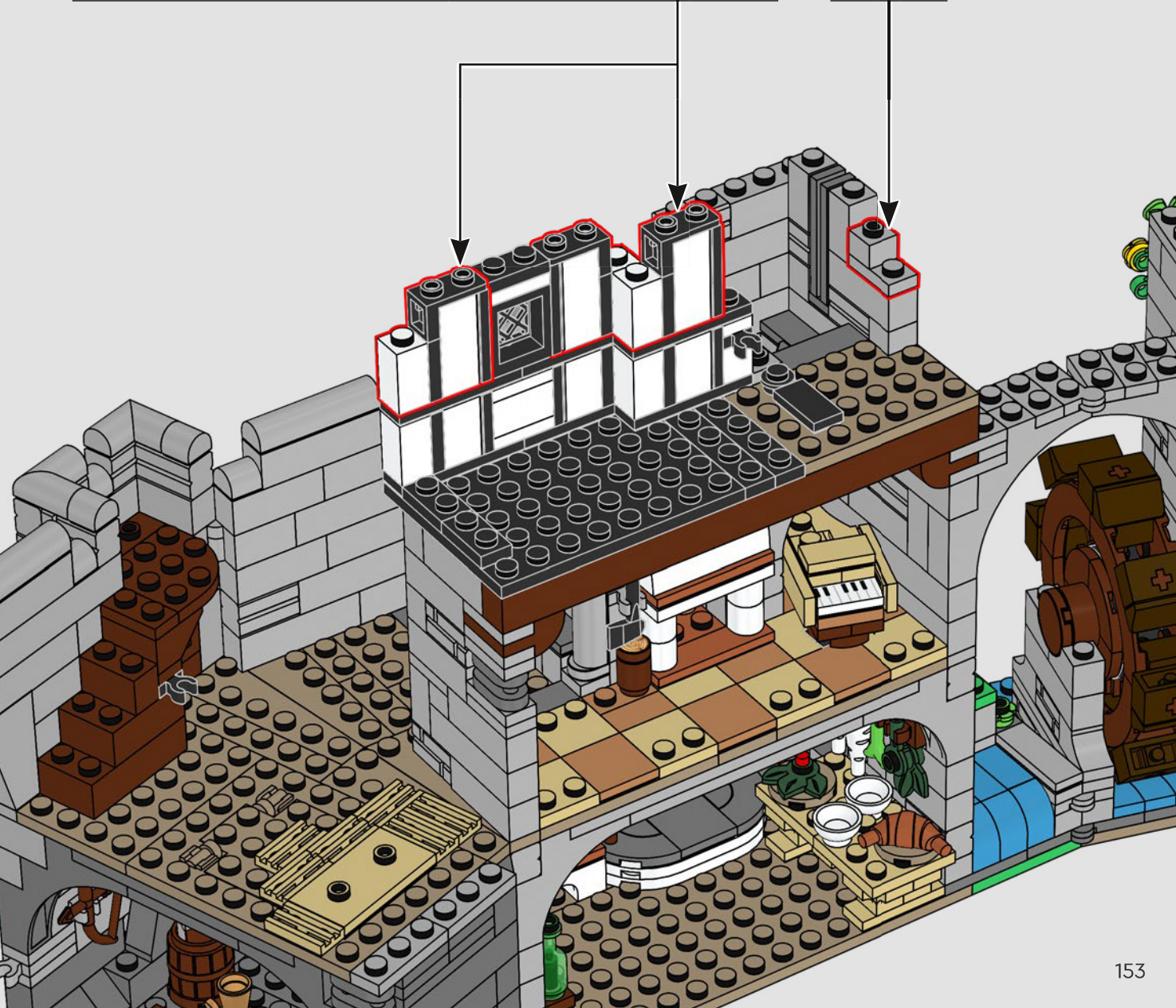
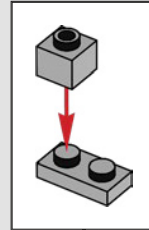
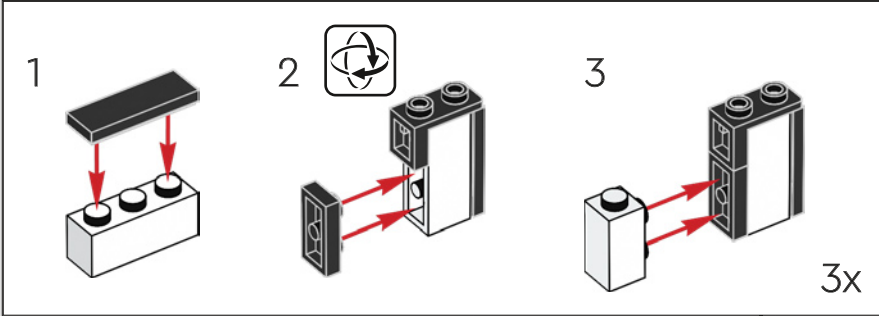

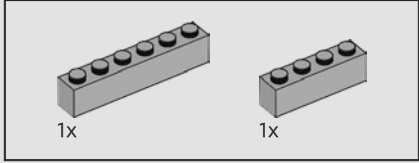
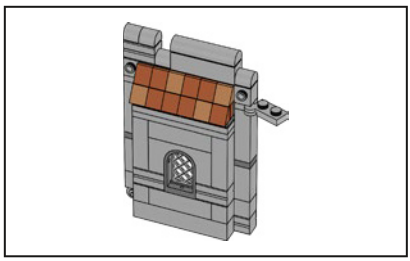

171

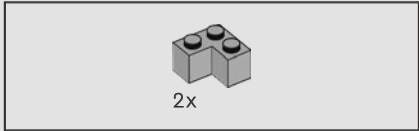
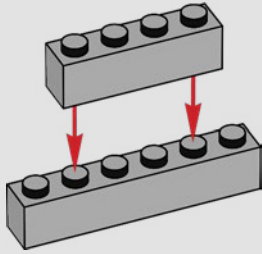

172

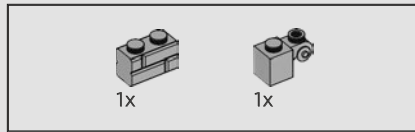
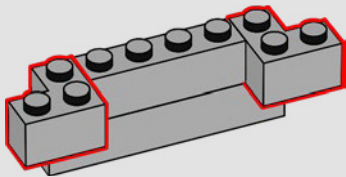

173

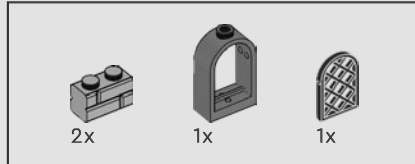
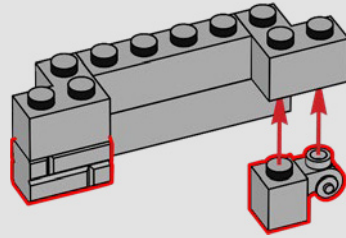

174

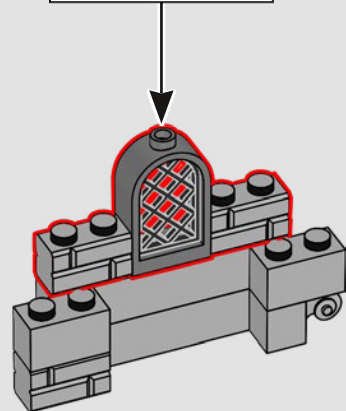
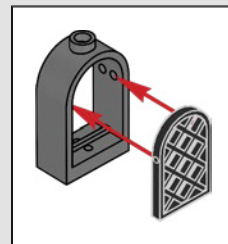

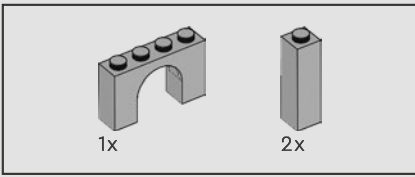

175

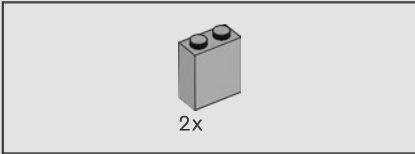
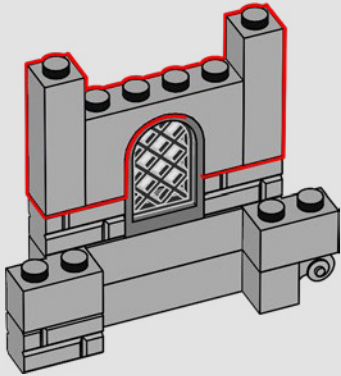

176

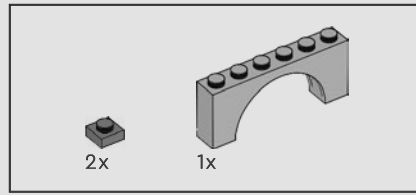
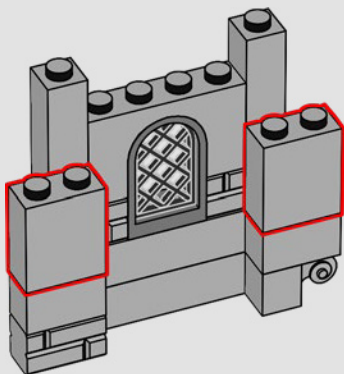

177

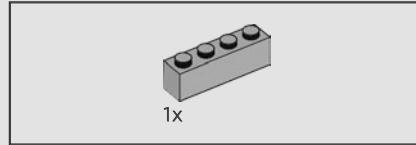
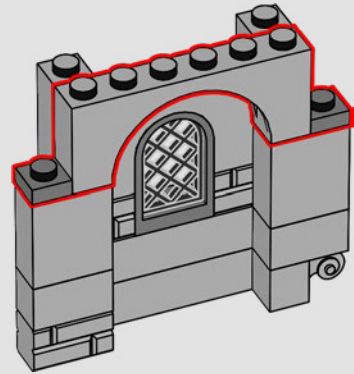

178

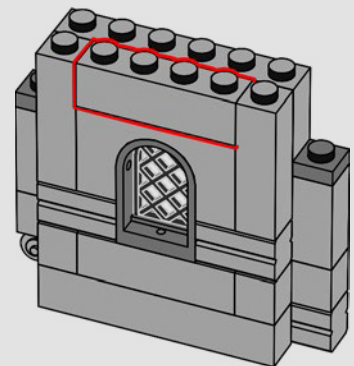

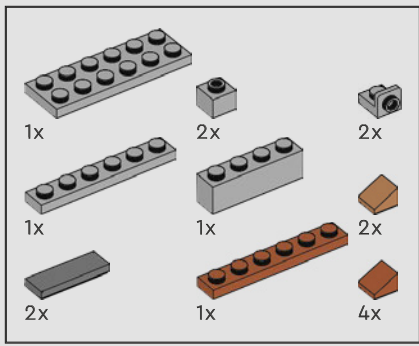

179

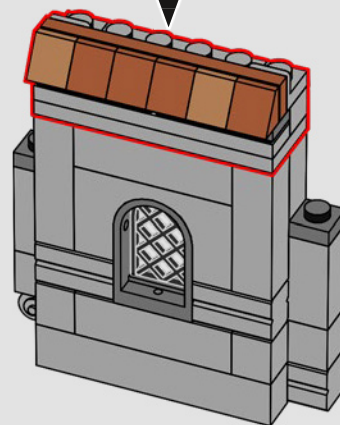
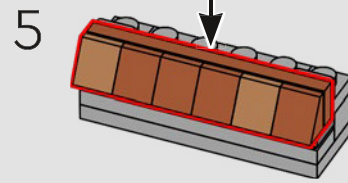
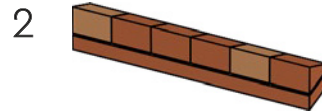
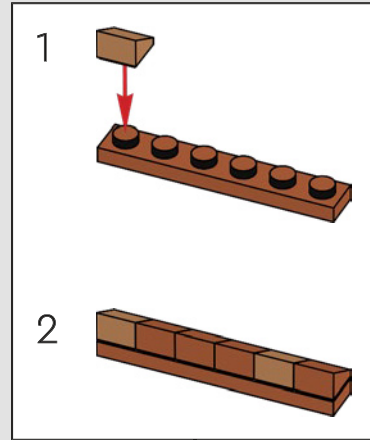
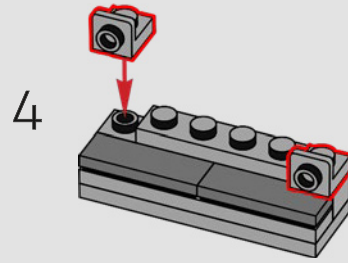
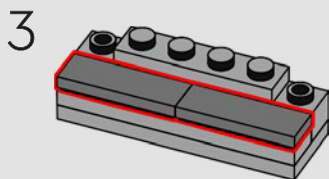
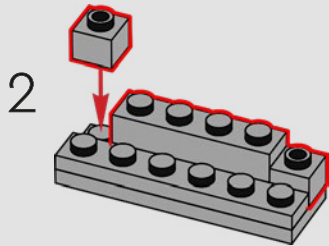
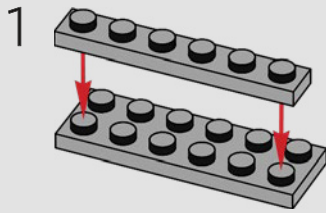

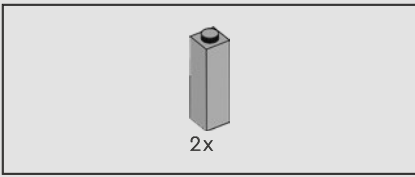

180

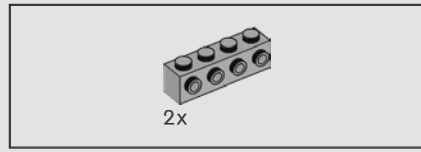
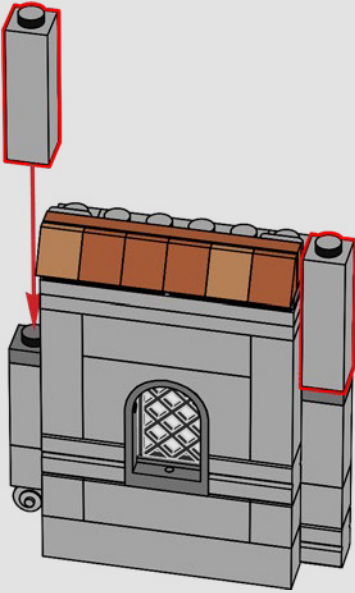

182

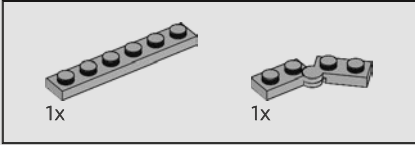
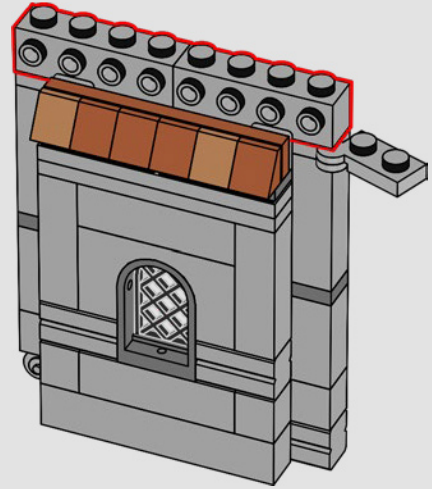

181

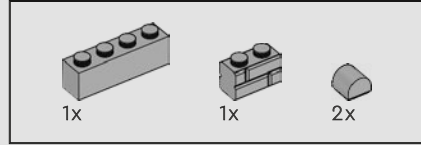
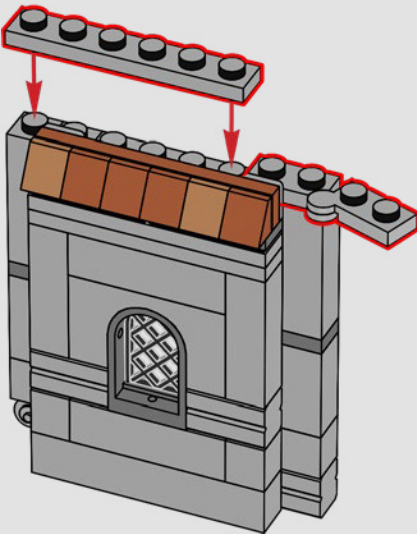

183

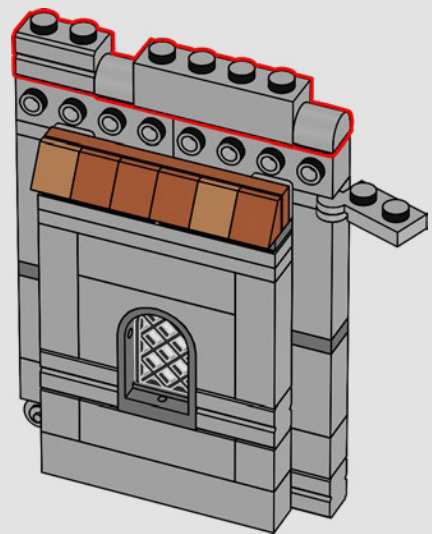

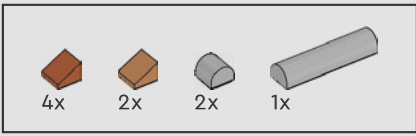

184

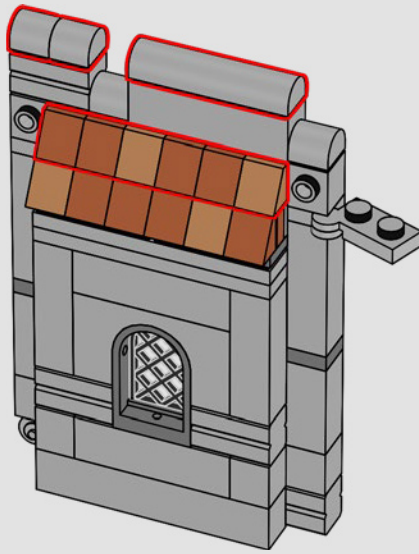

185

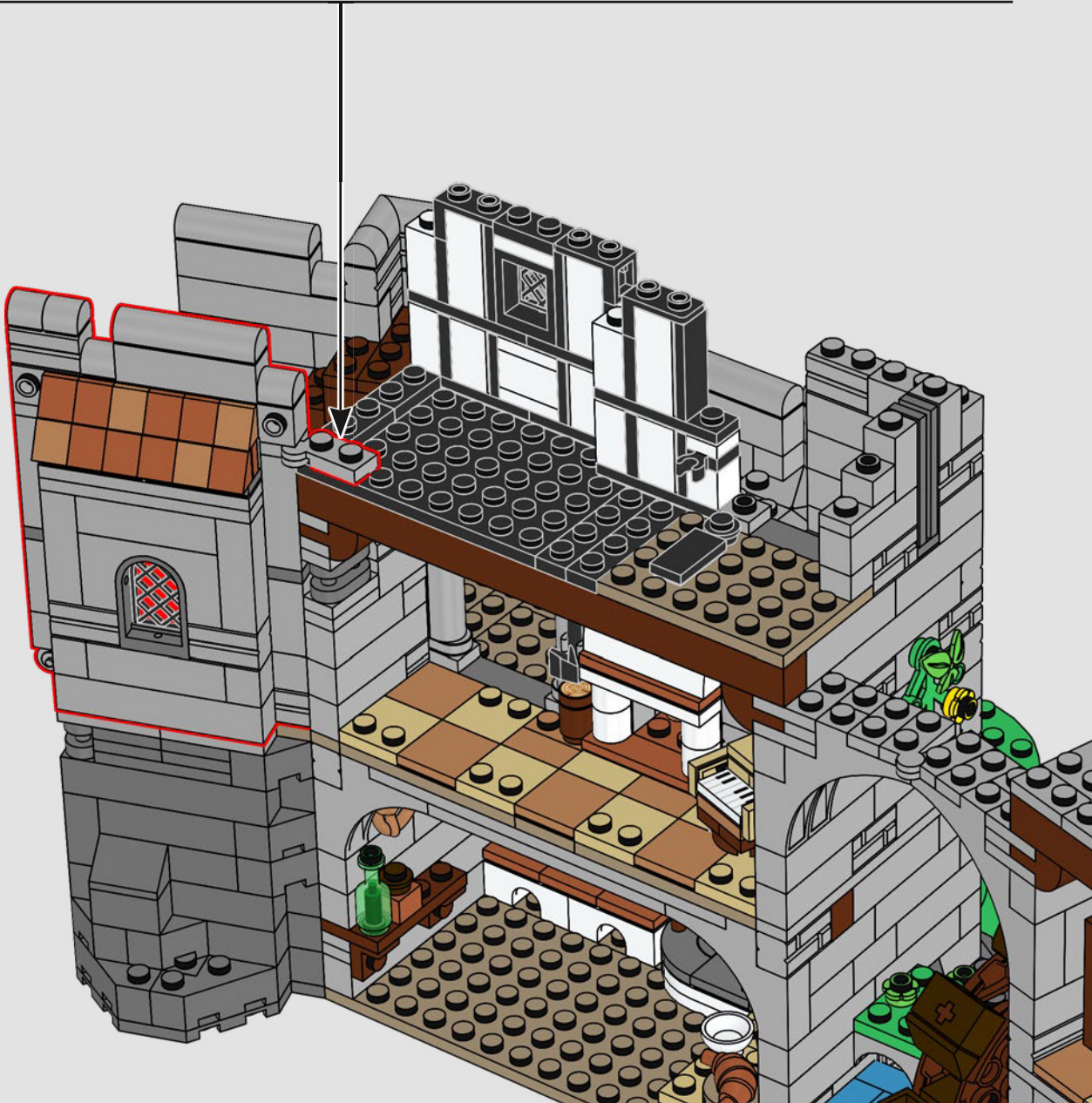

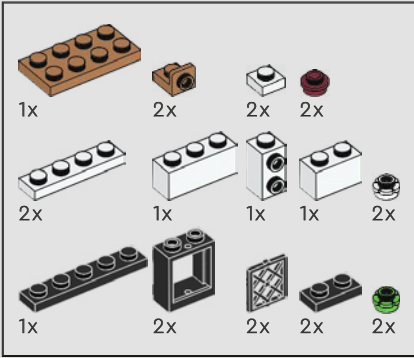
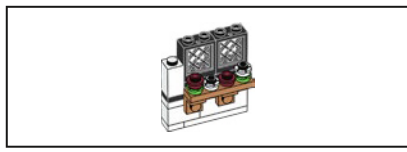

186

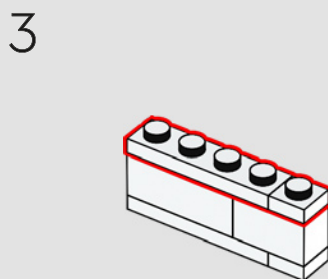
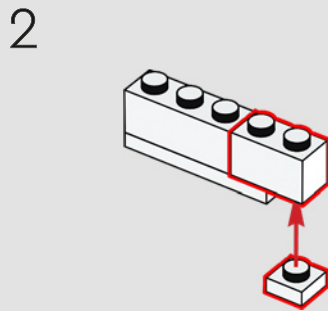
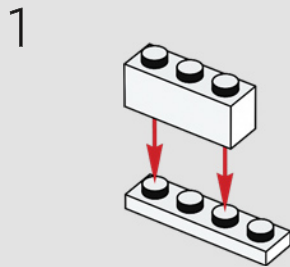

4

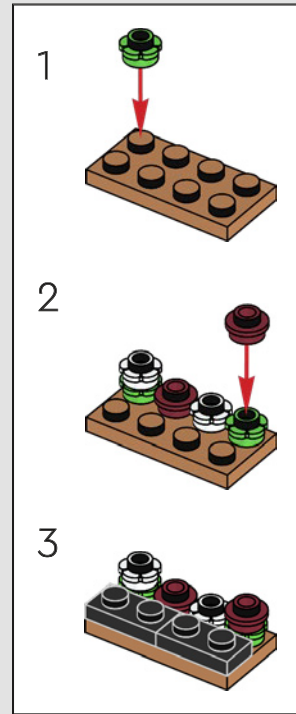
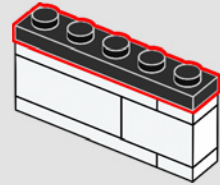

5

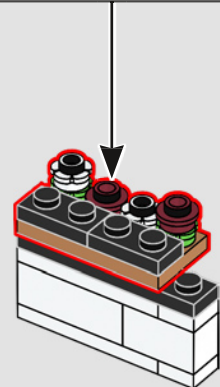

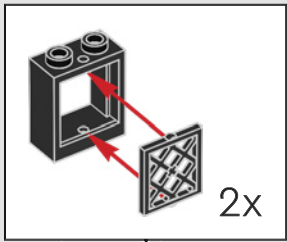

6

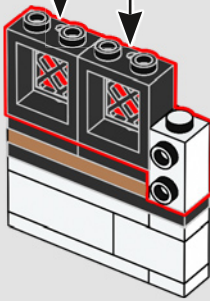

7

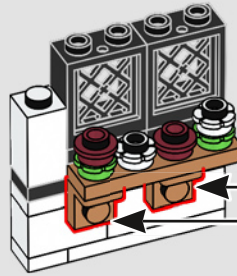

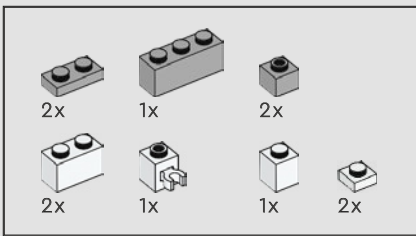

187

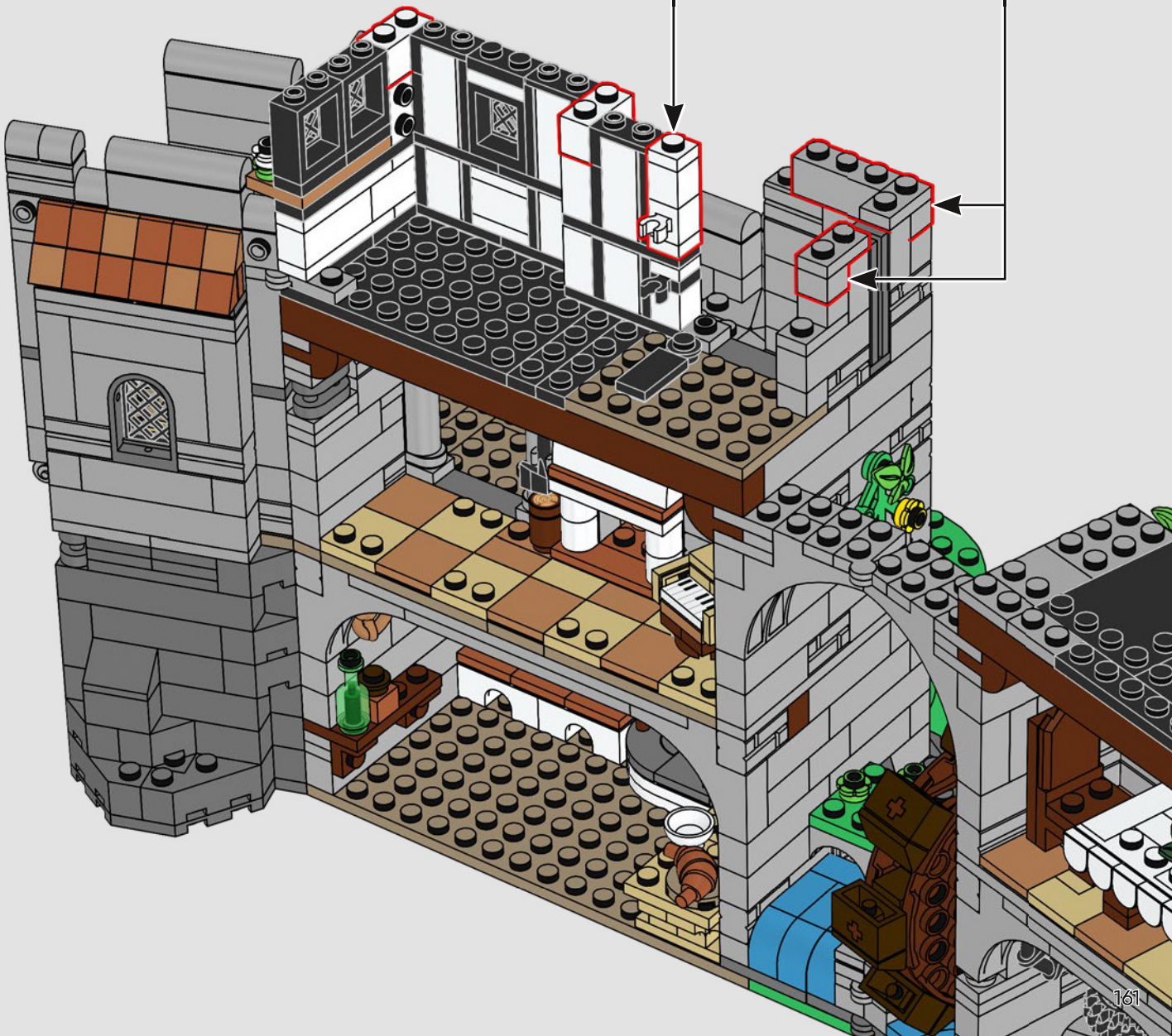
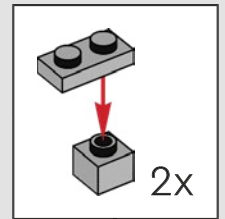
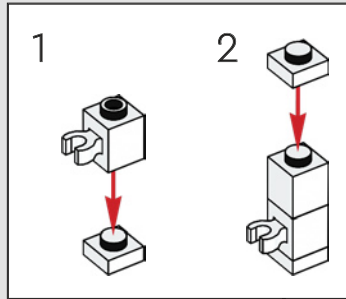

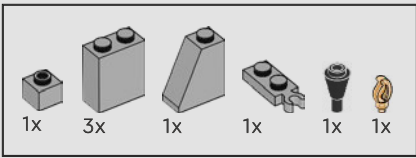

188

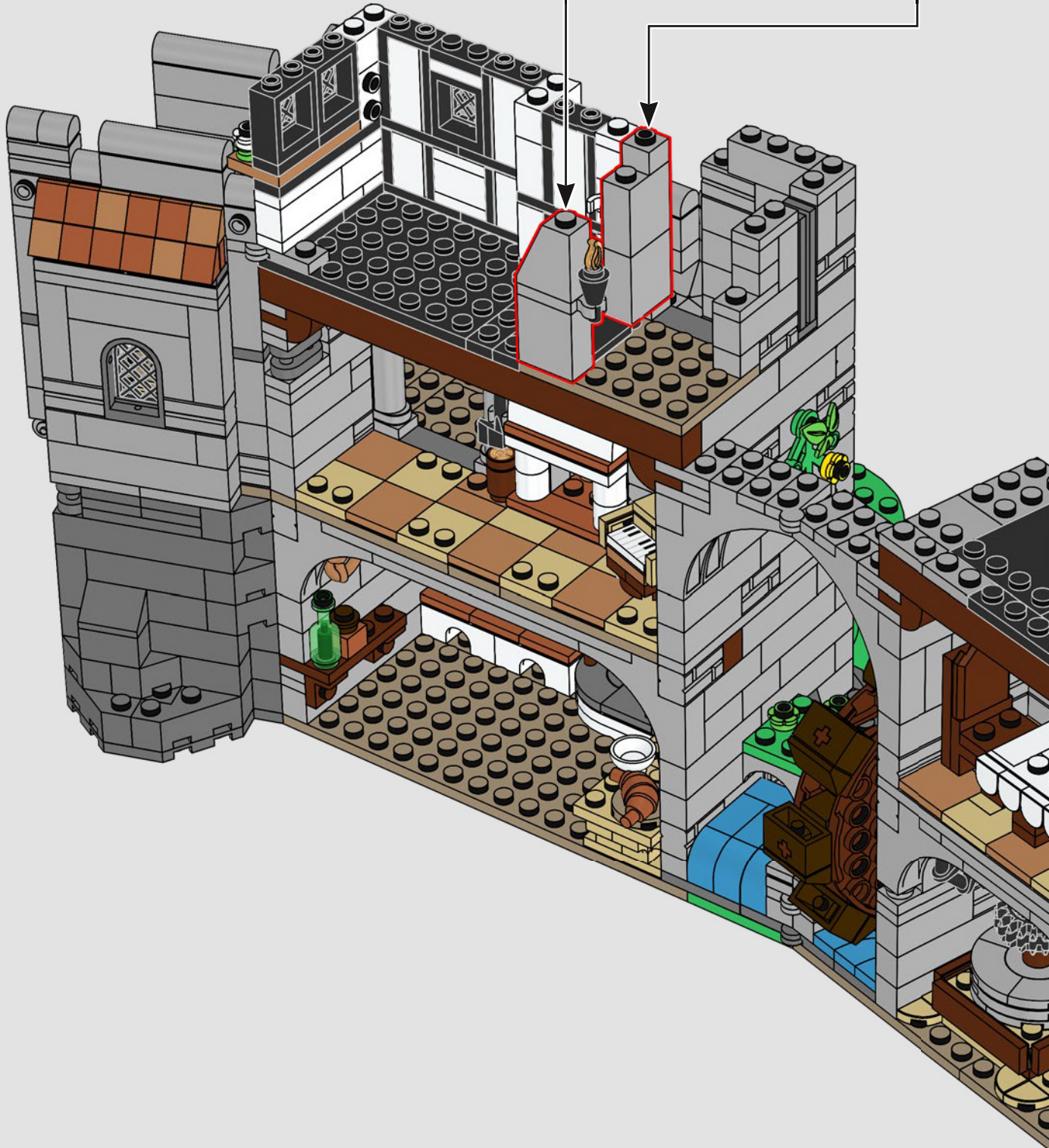
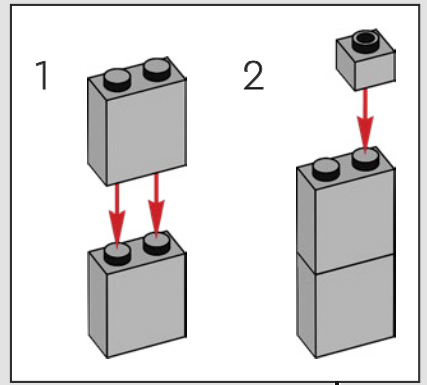
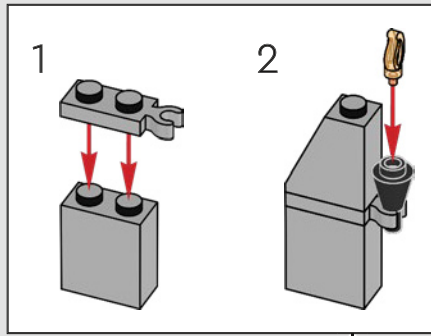

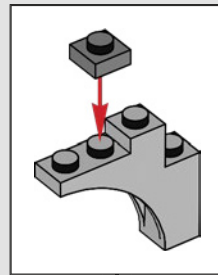
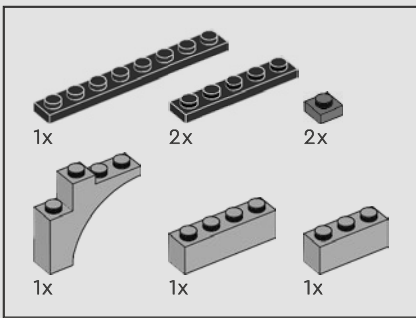

189

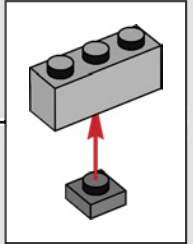
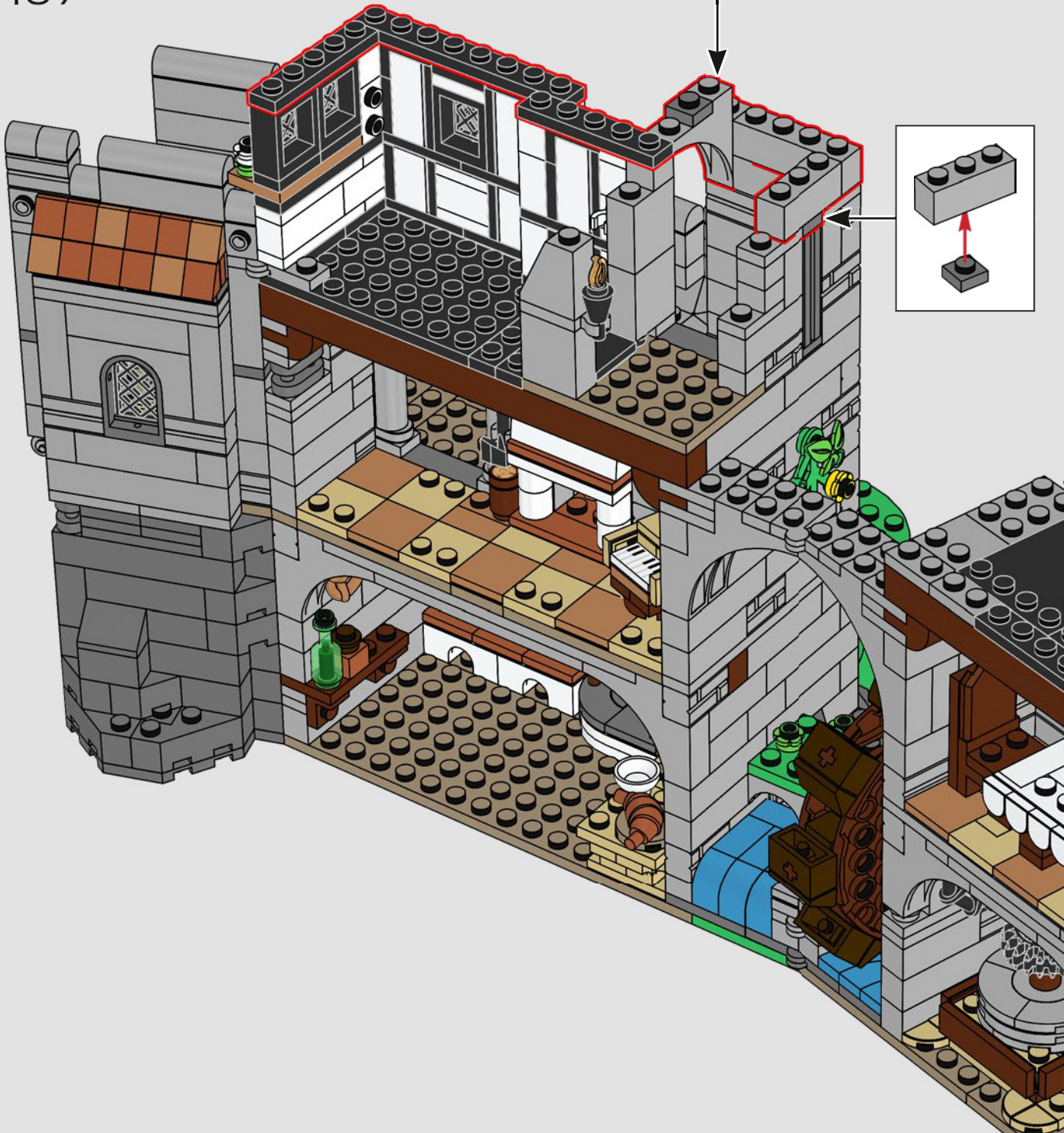

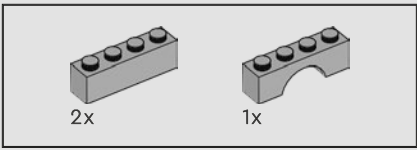

190

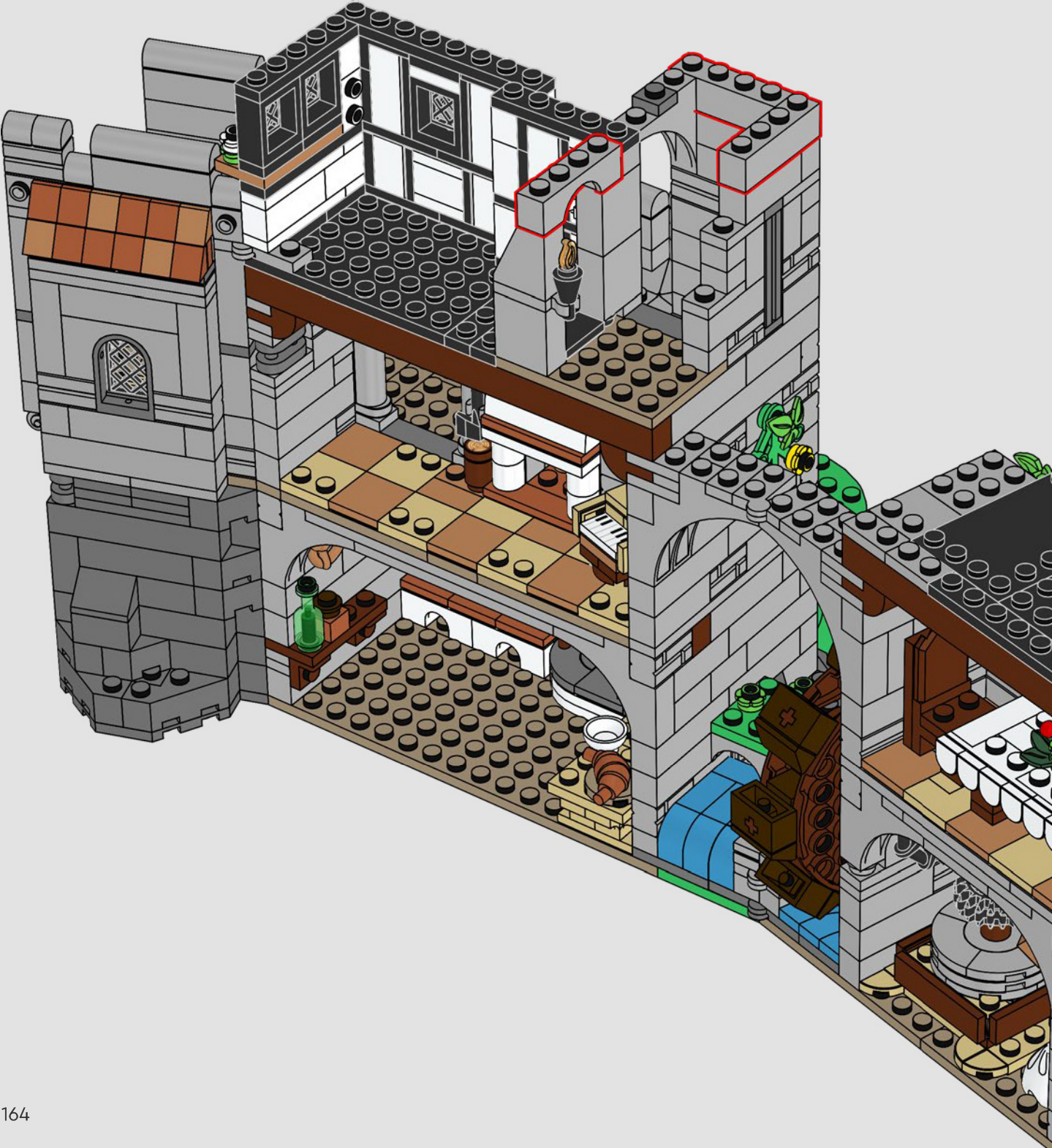



¡Qué bella artesanía! Me recuerda a un castillo de hace muchas generaciones...

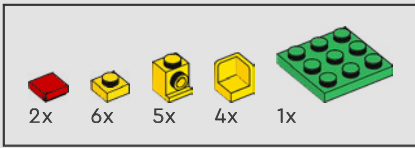

191

1

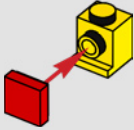

2

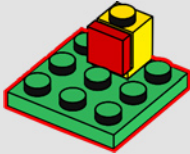

3

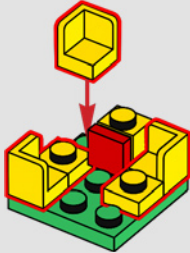

4

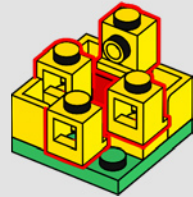

5

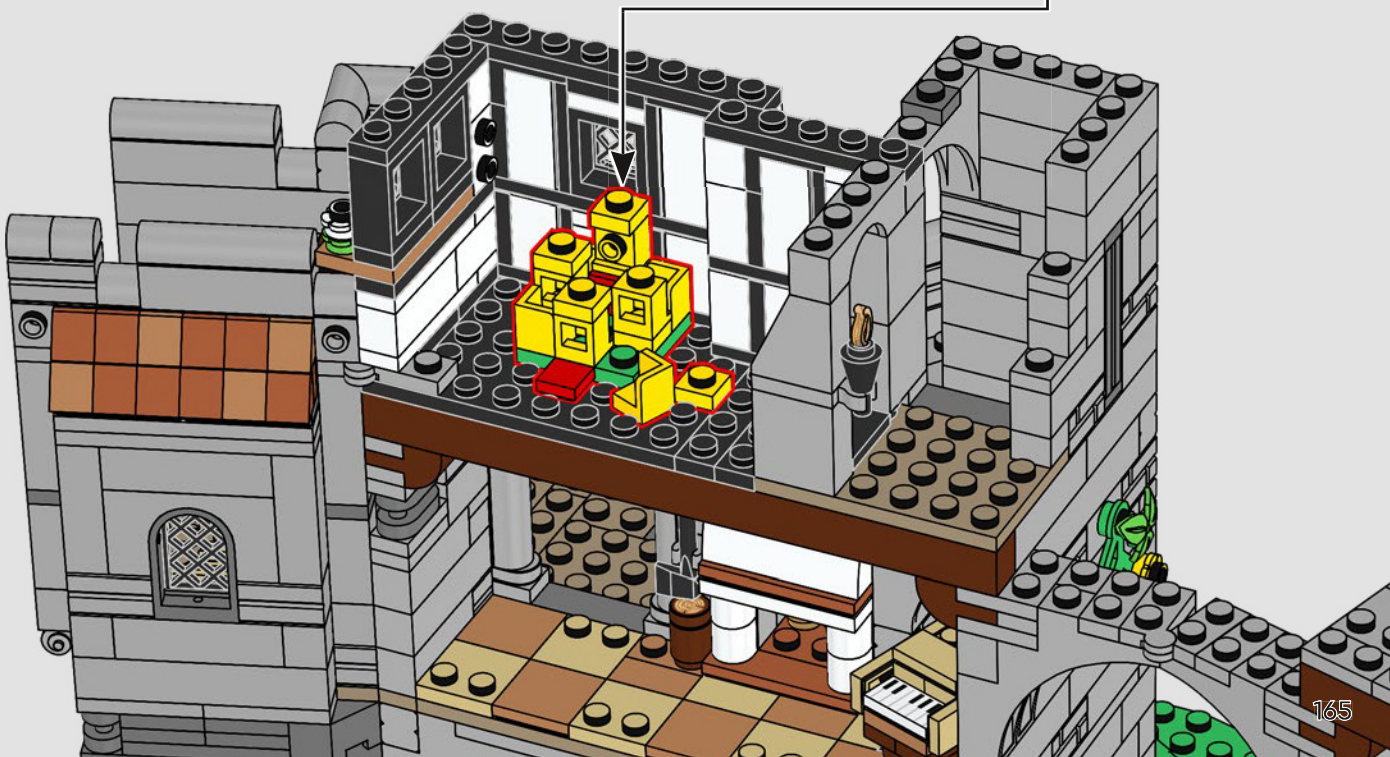
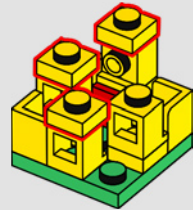

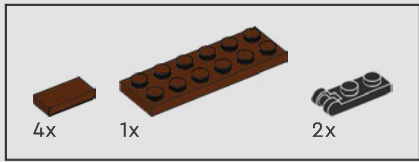

192

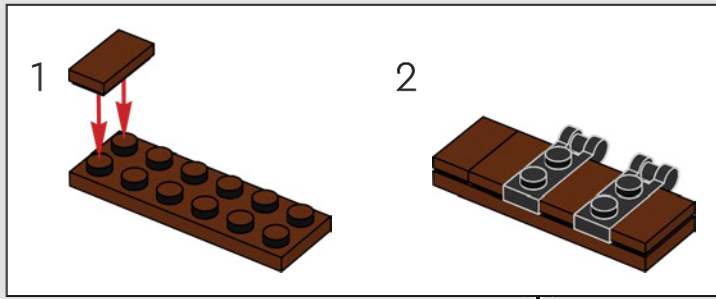

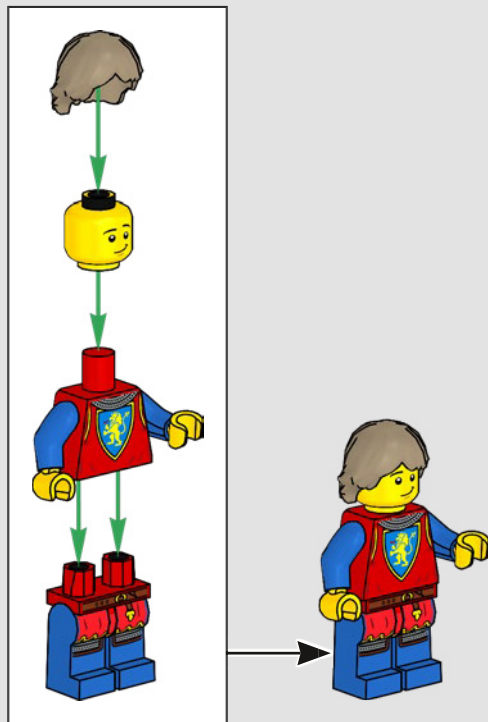

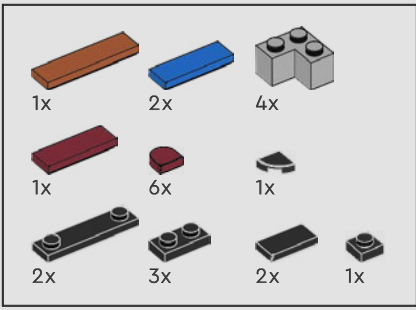

193

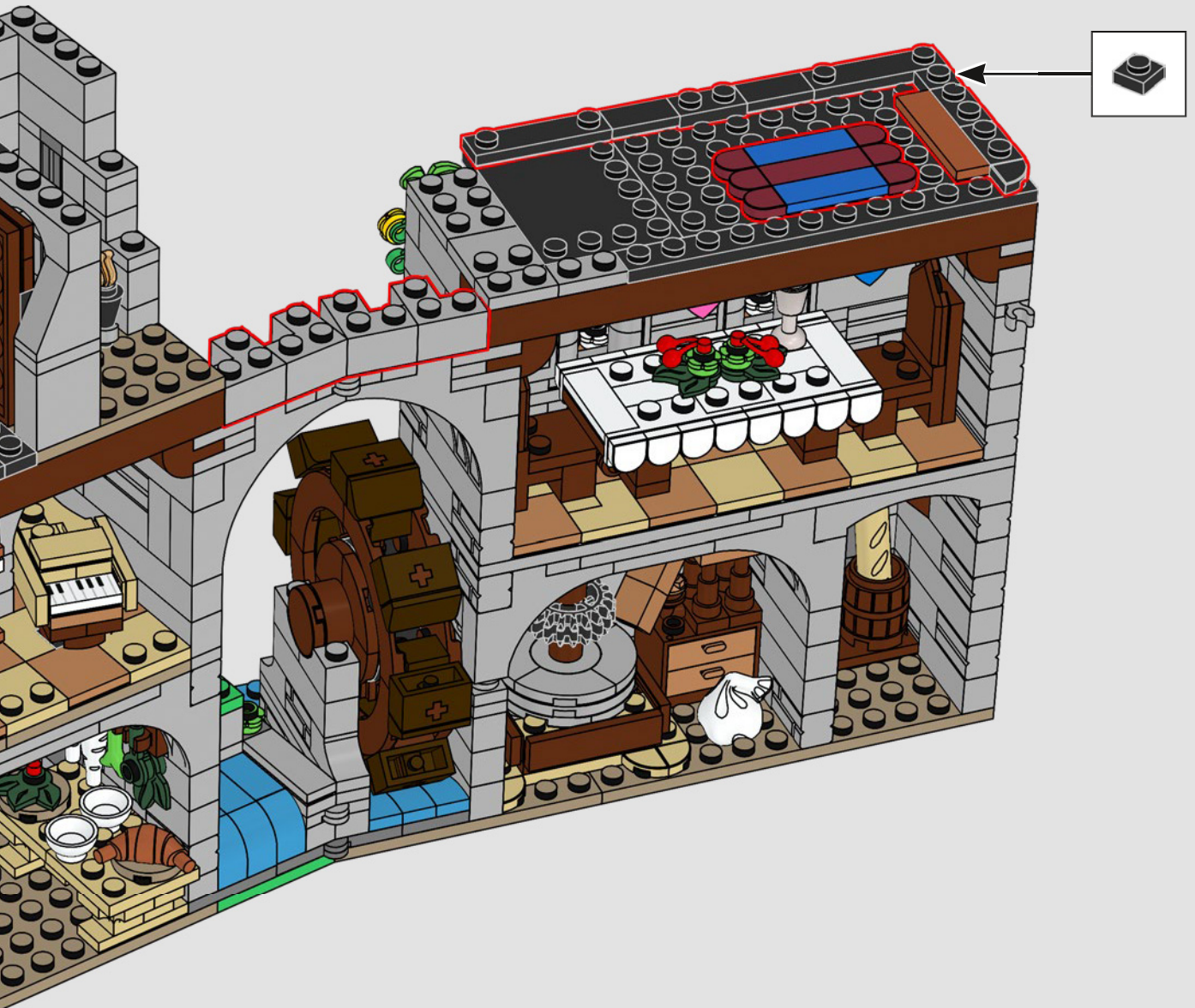

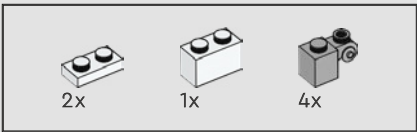

194

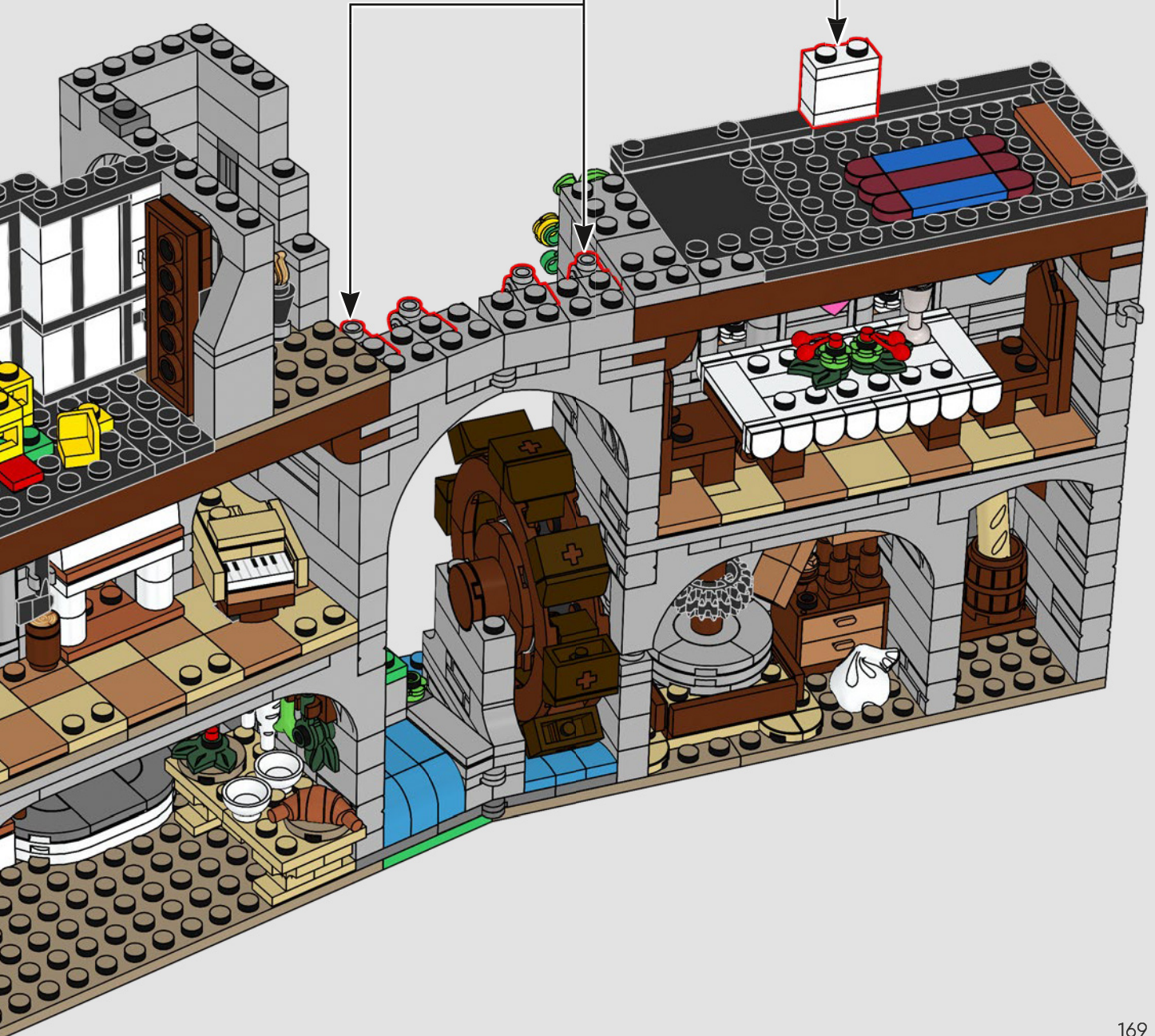
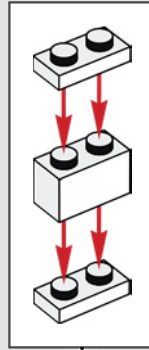
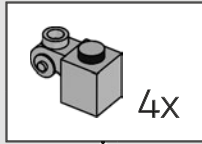

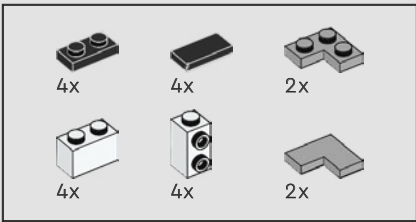

195

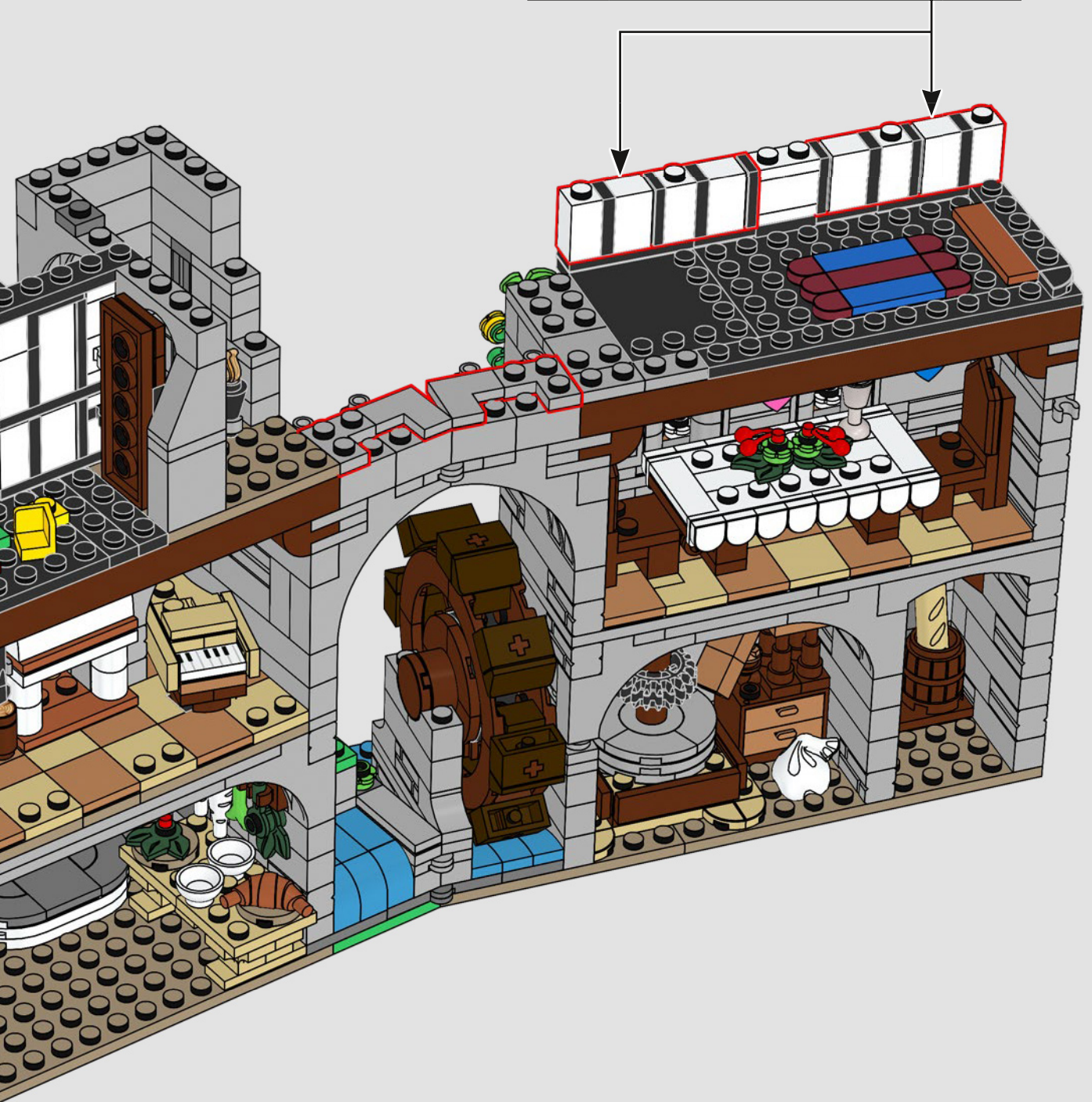
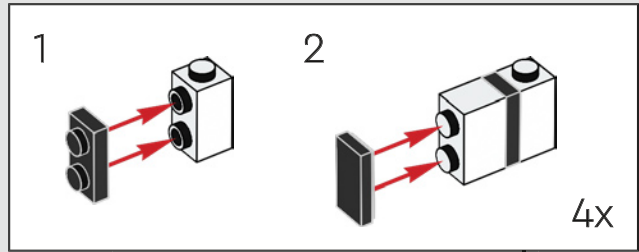

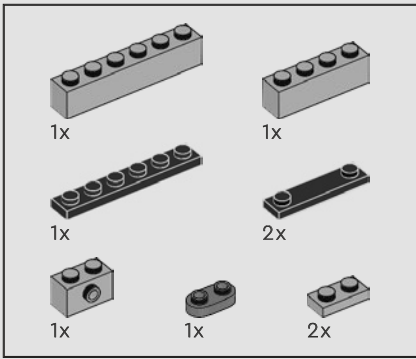

196

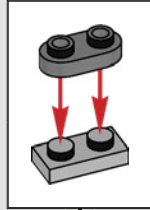

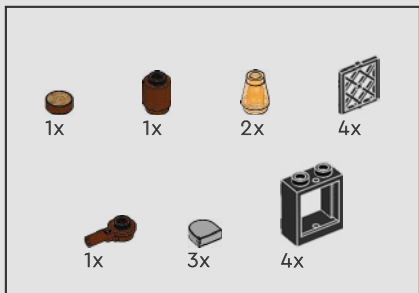

197

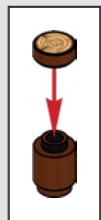
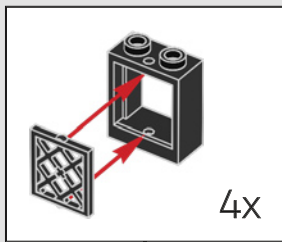

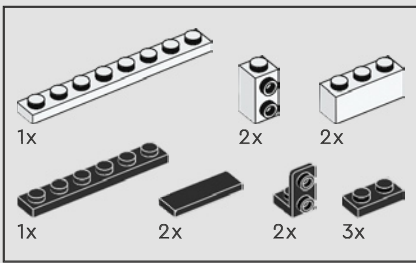

198

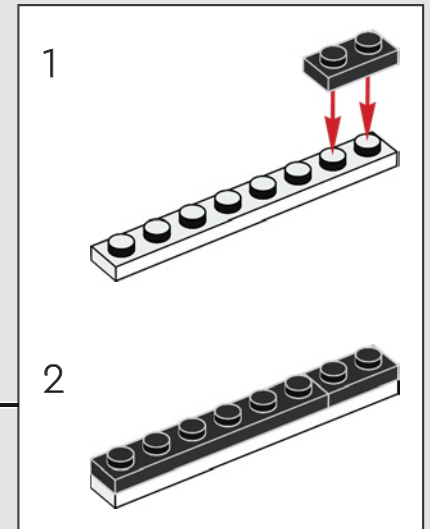
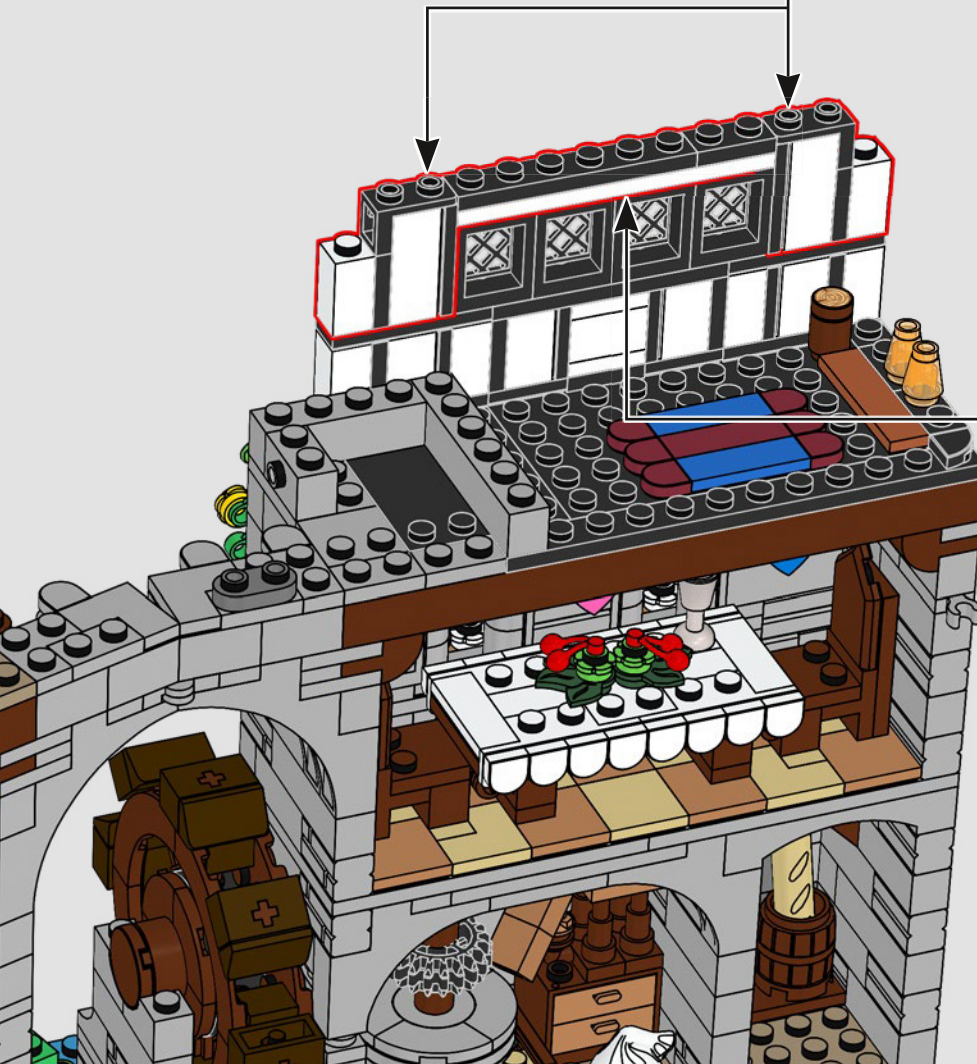
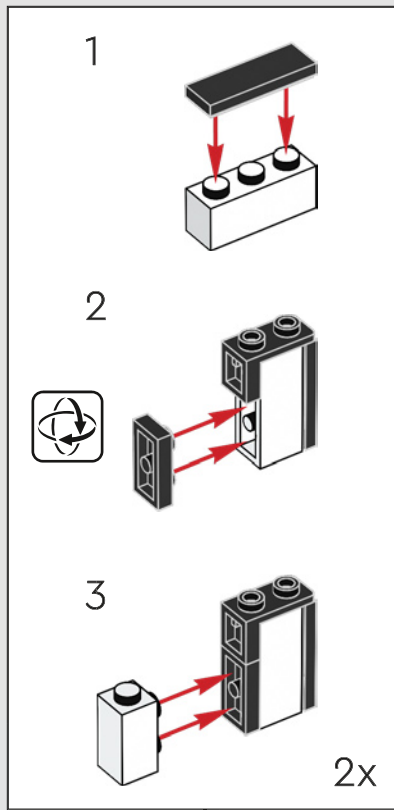

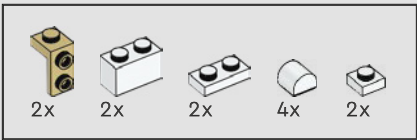

199

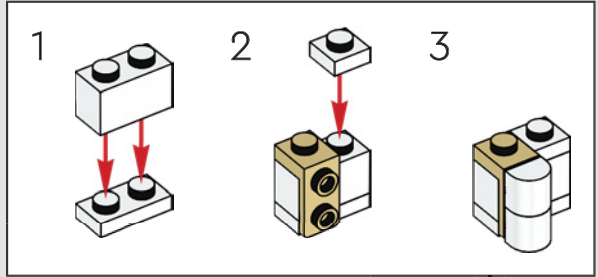
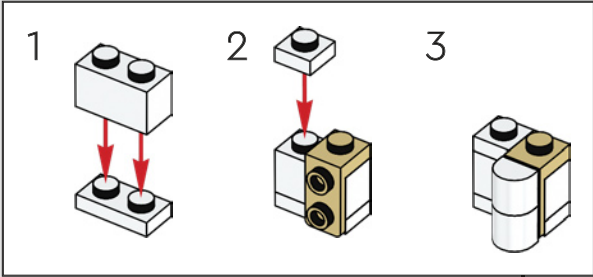

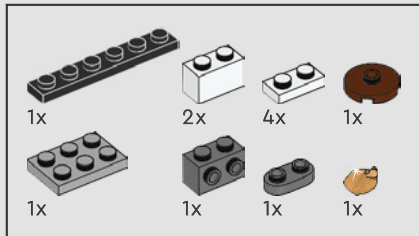

200

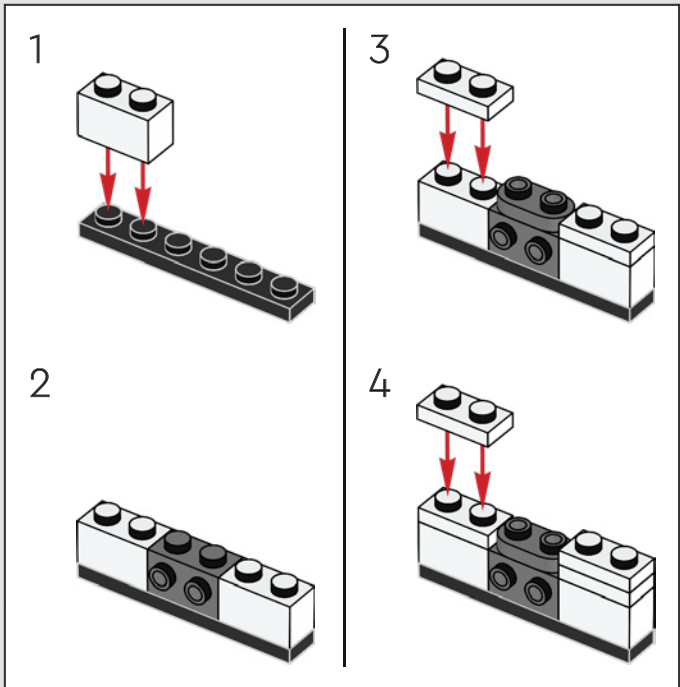
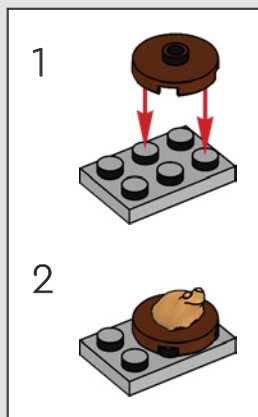

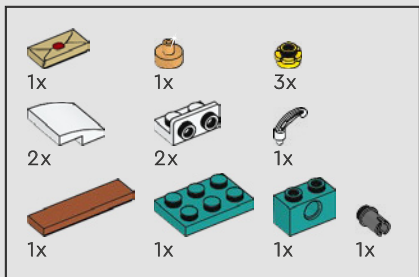

201



¿Qué hace esta extraña carta sobre la mesa y por qué porta el sello de Lord Basil?

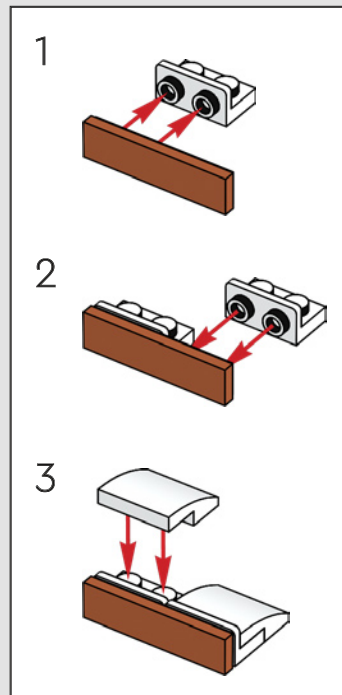
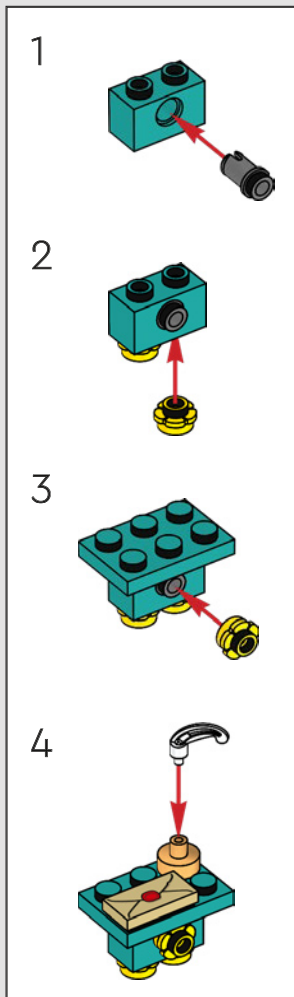

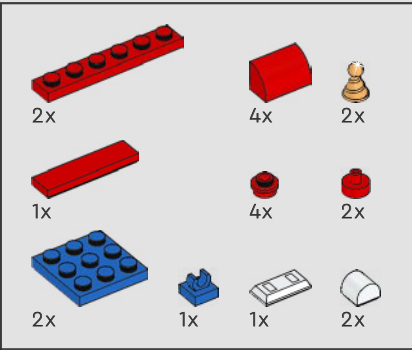
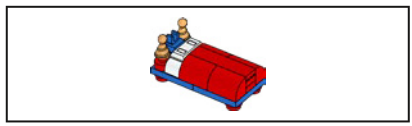

202

1

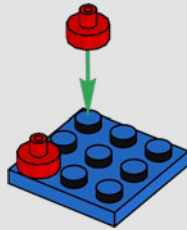

2

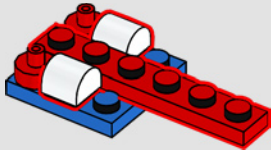

3

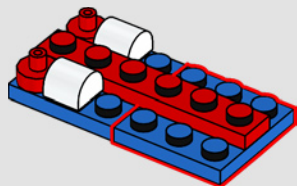

4

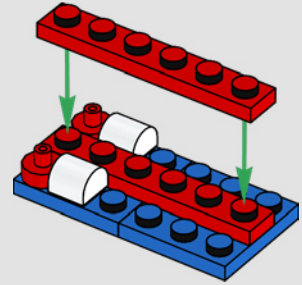

5

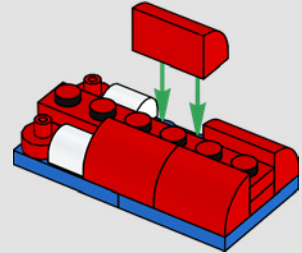

6

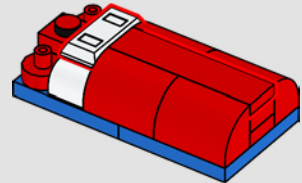

7

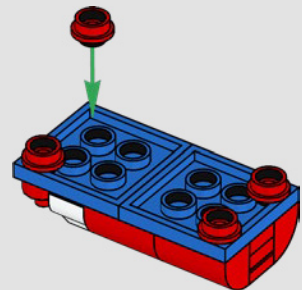

8

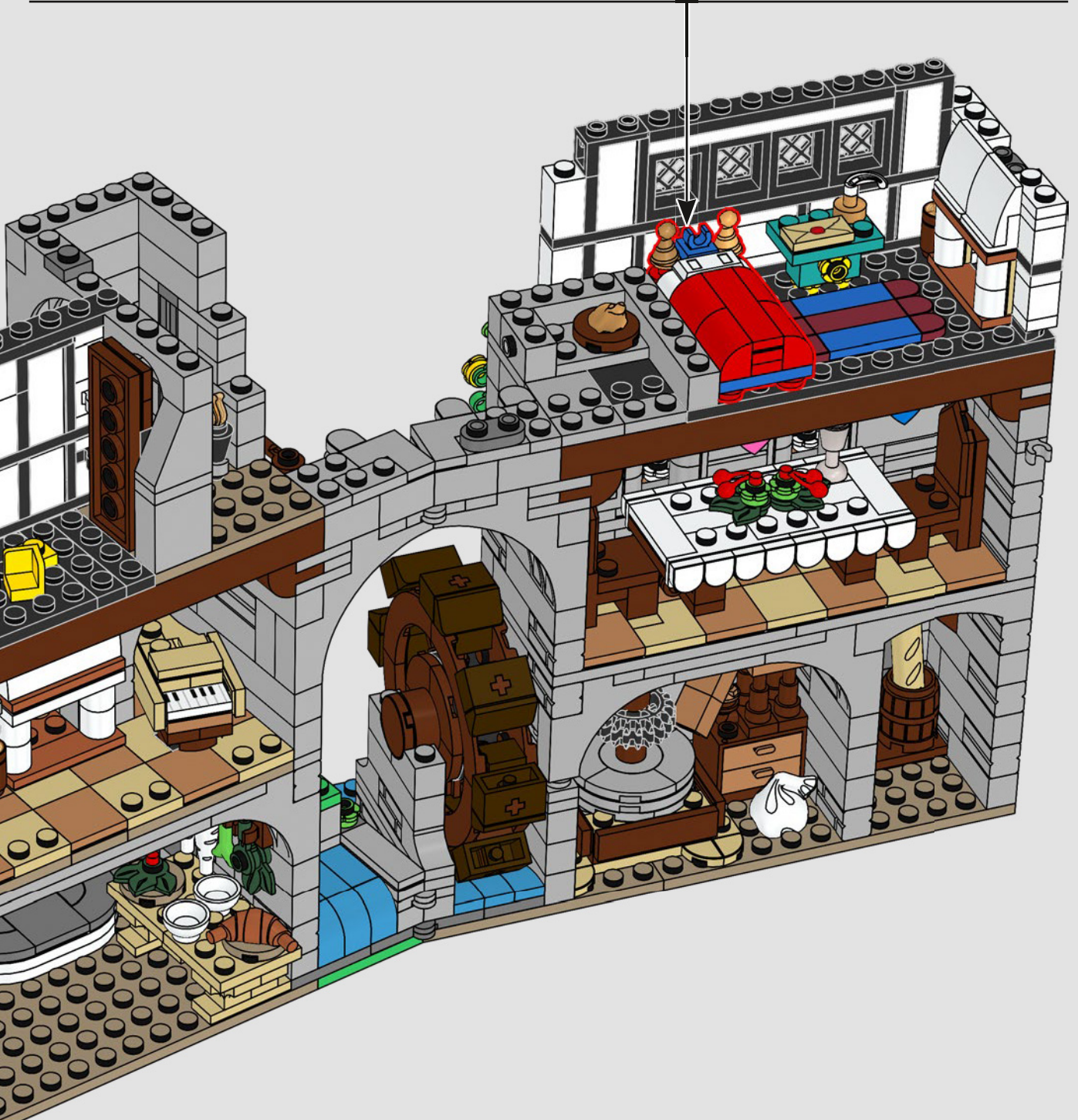
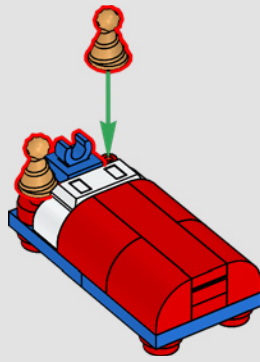

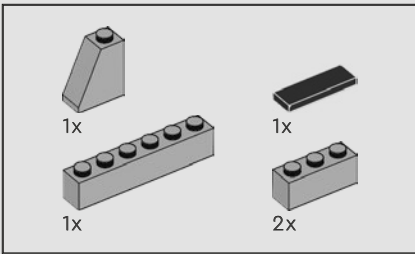

203

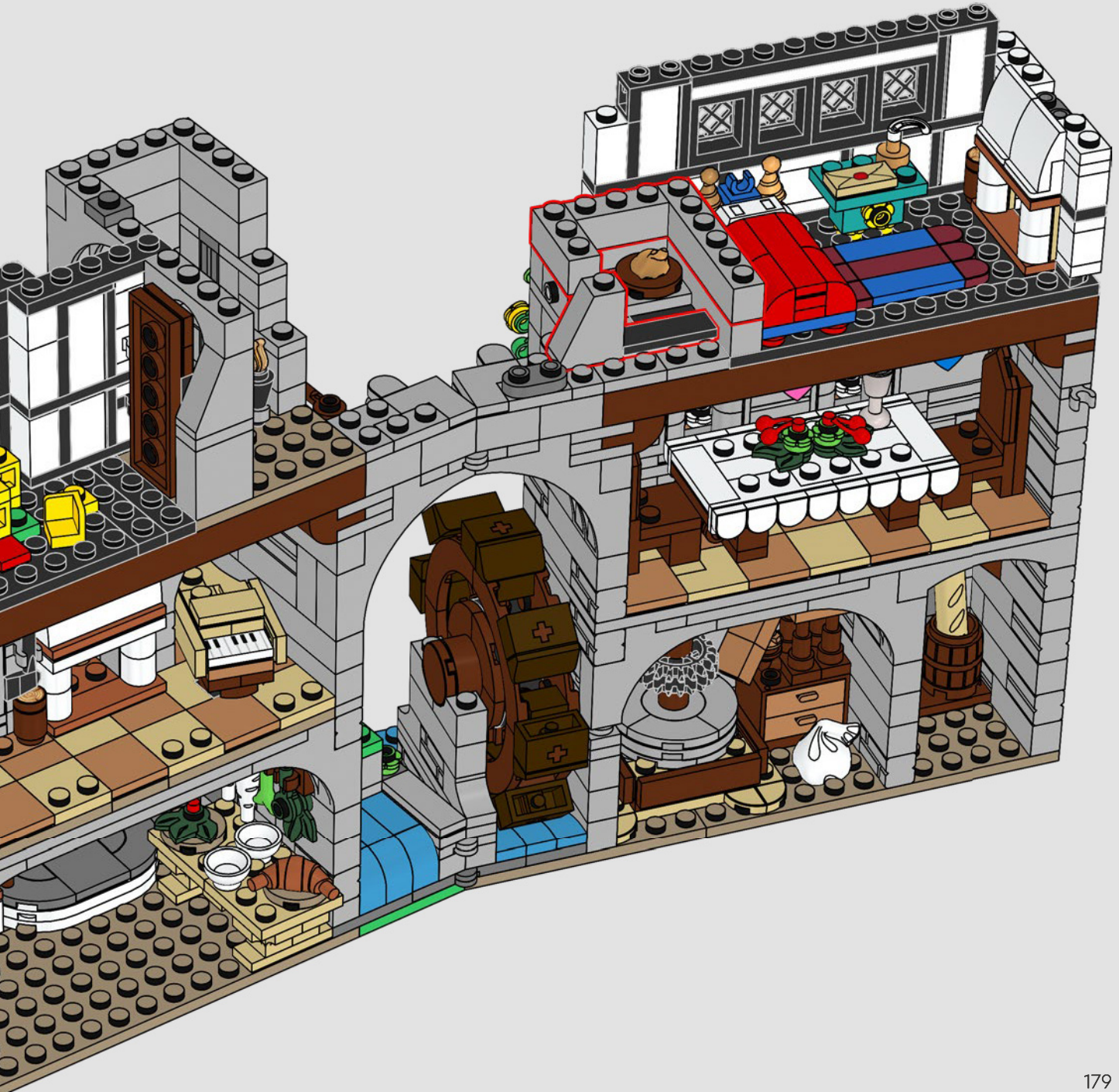

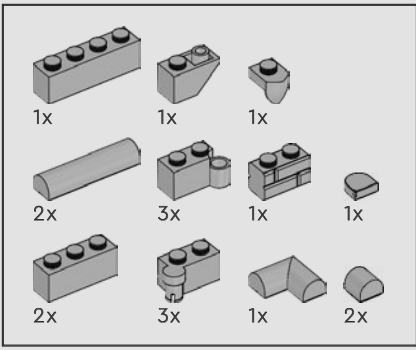

204

1

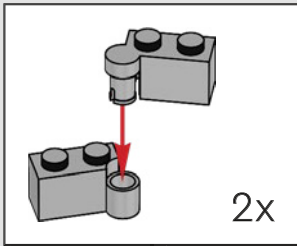
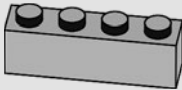

2

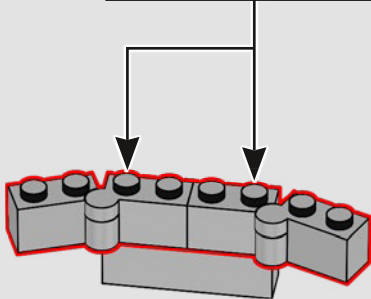

3

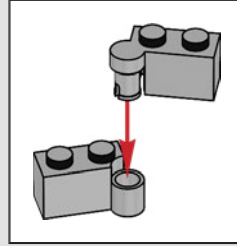
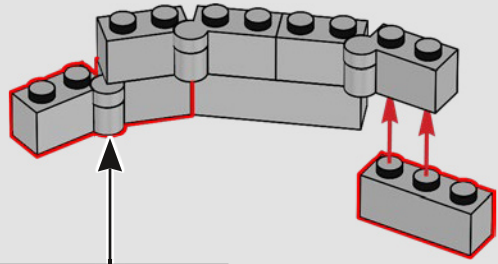

4

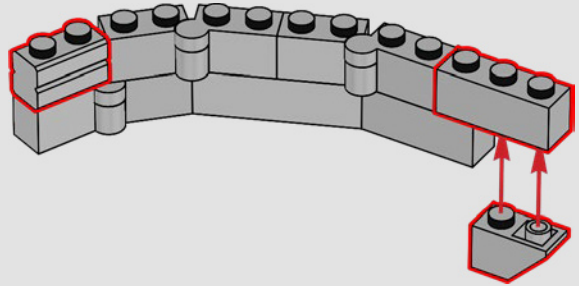

5

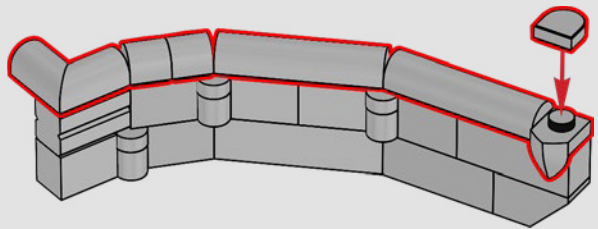

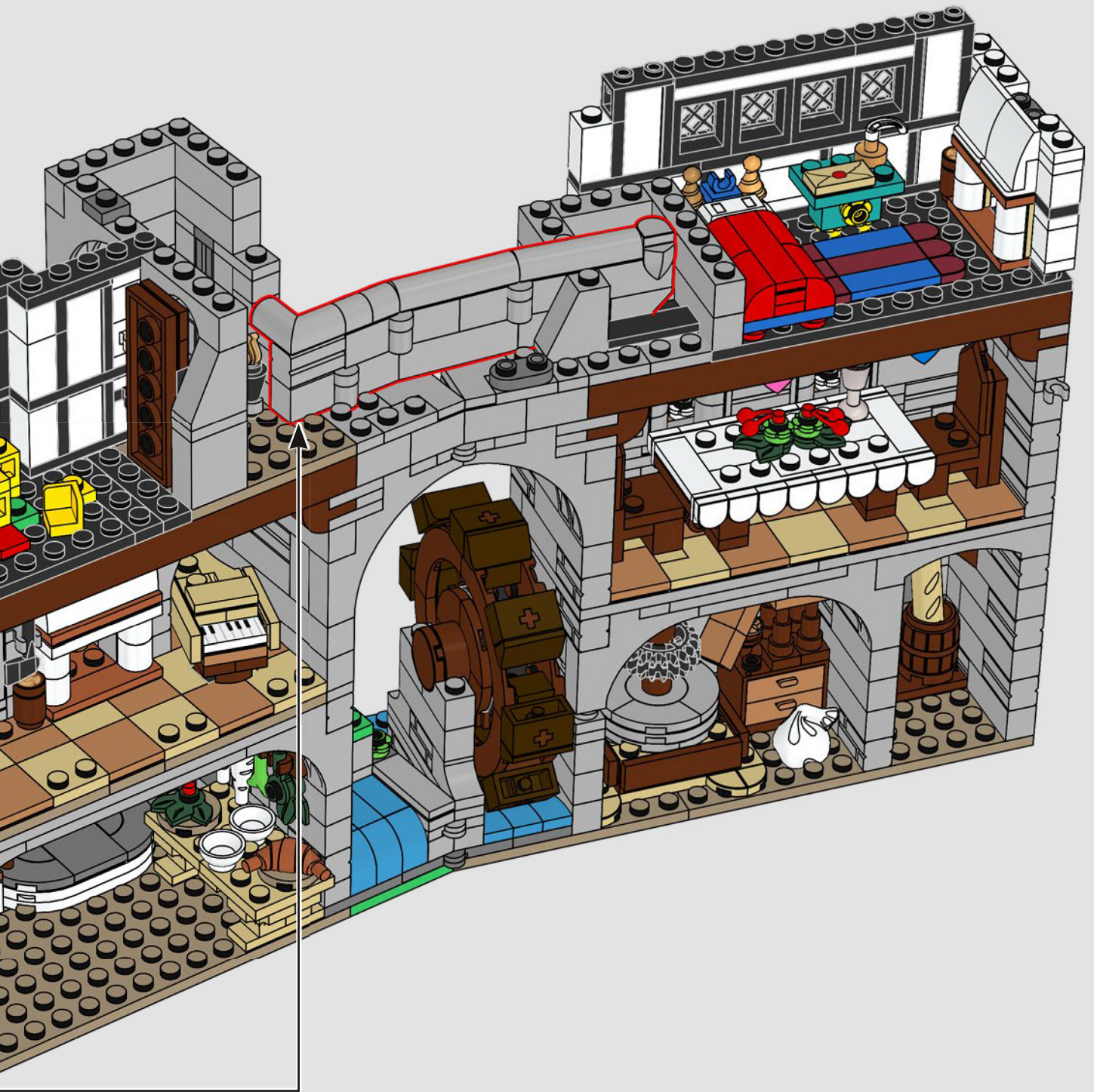



¡Este muro posee magia! Se
necesitará un poco más de estudio
para llegar al fondo de este misterio.

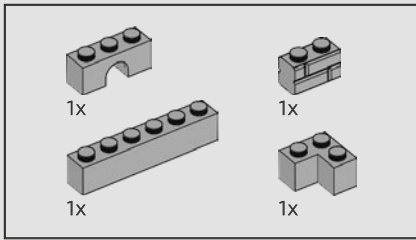

205

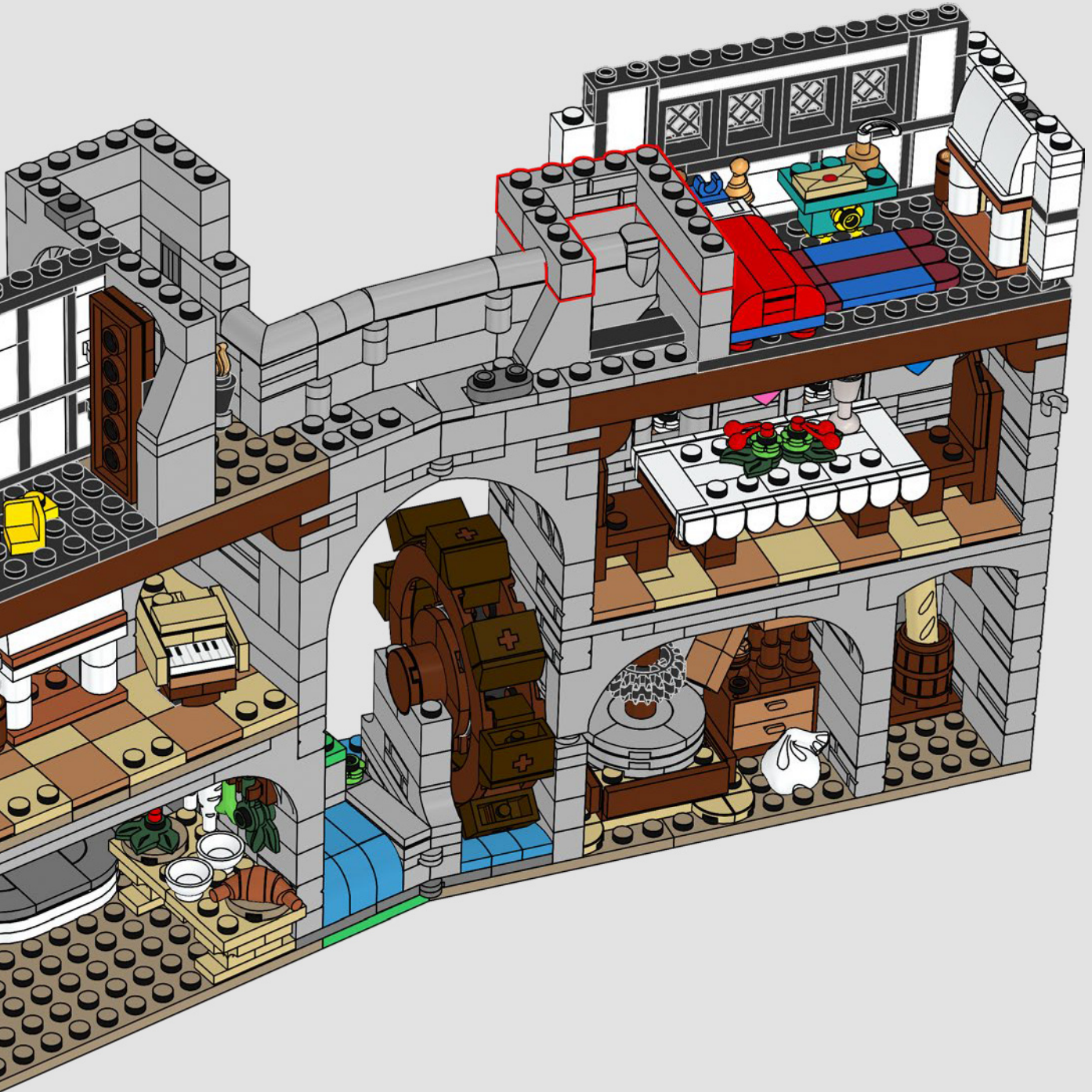

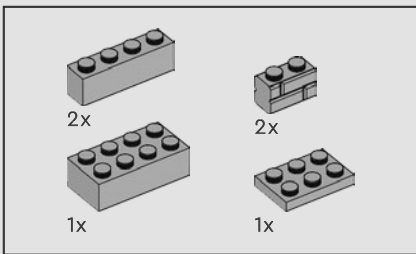

206

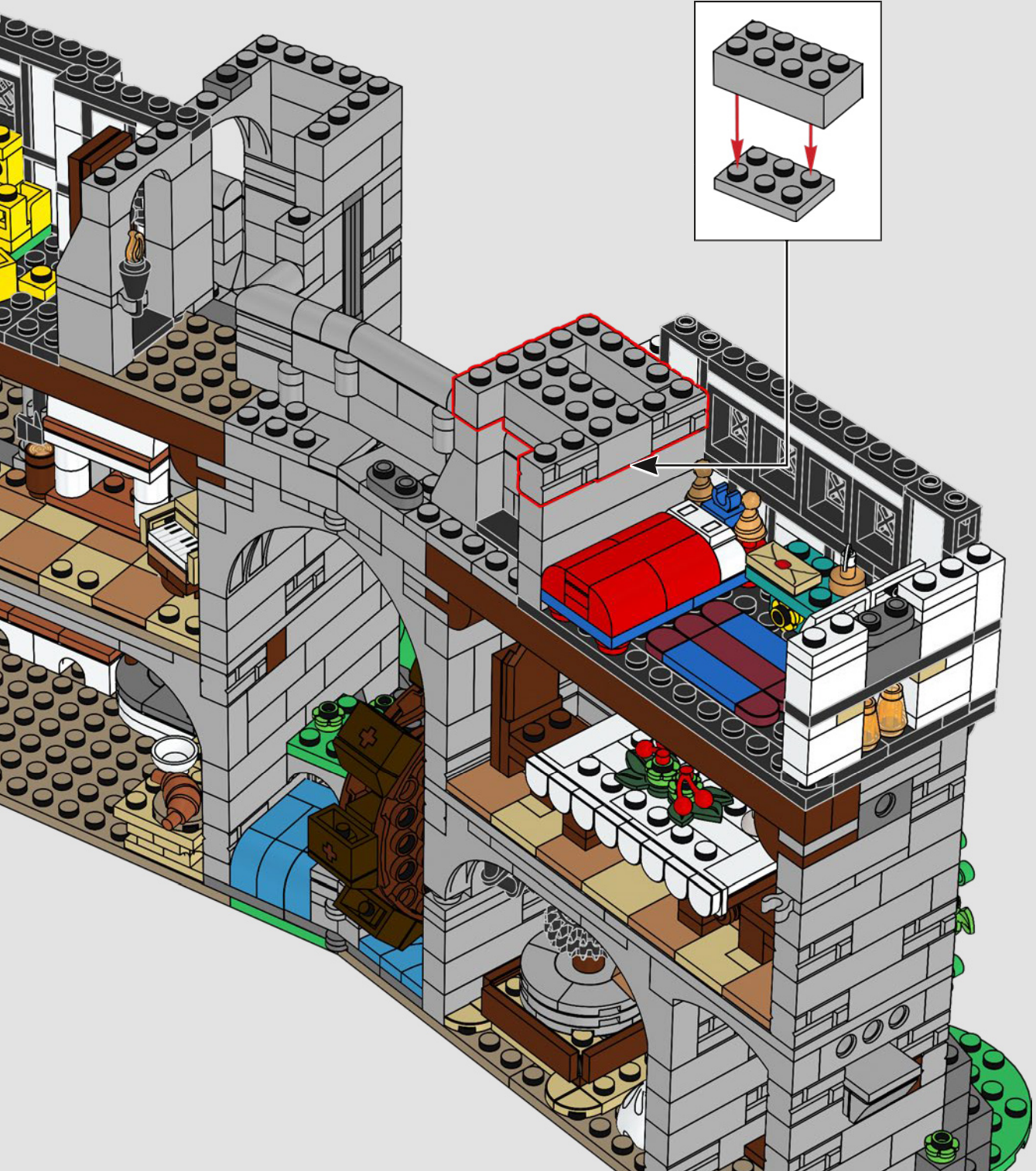

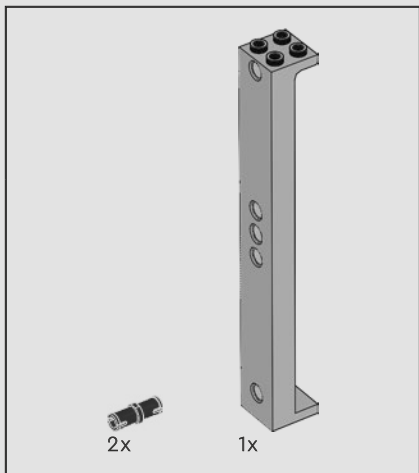

207

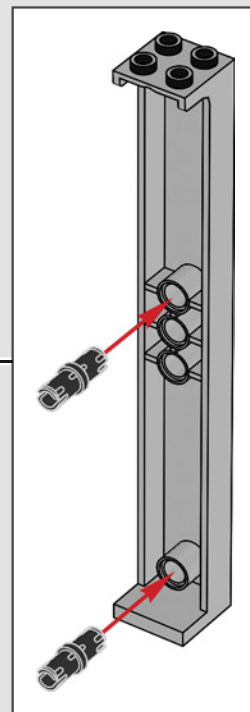
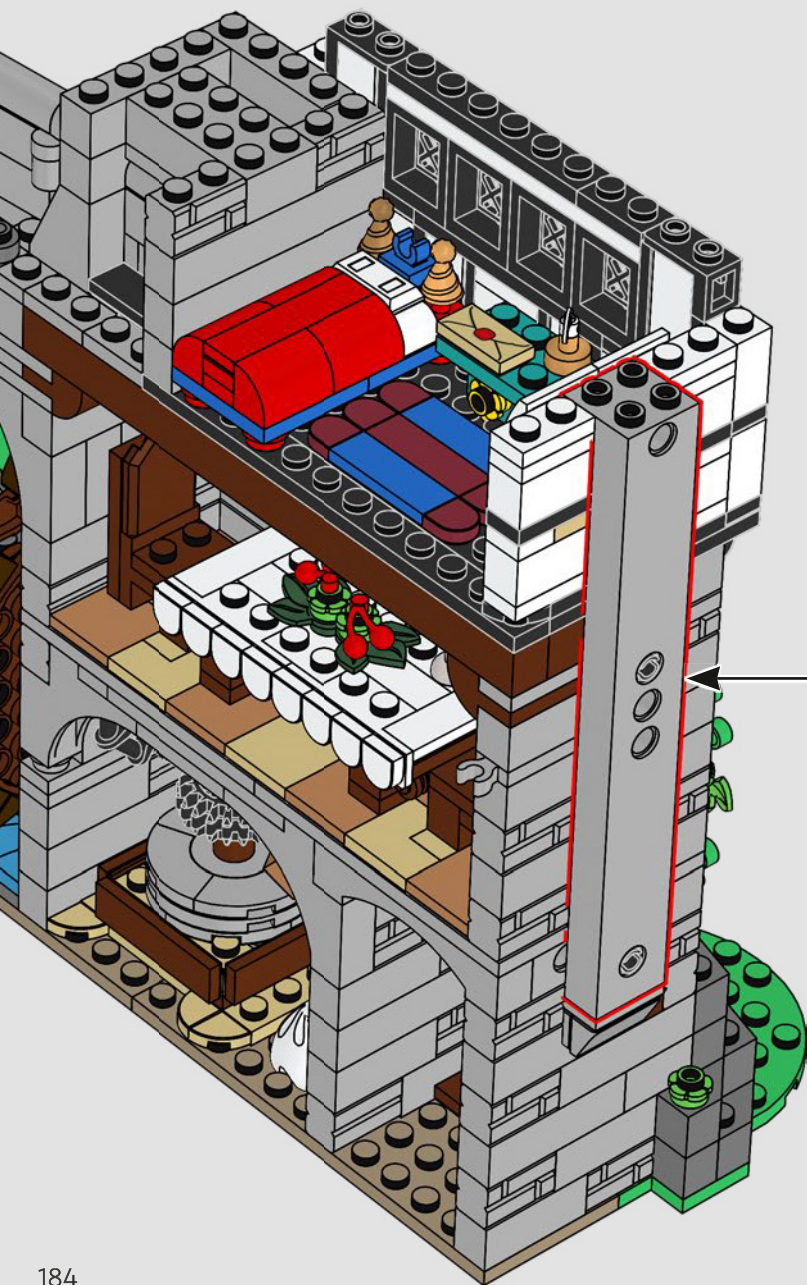

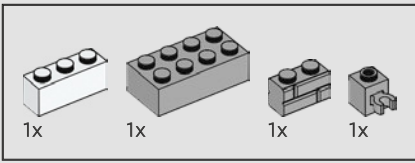

208



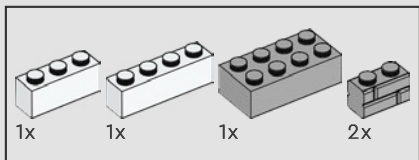

209



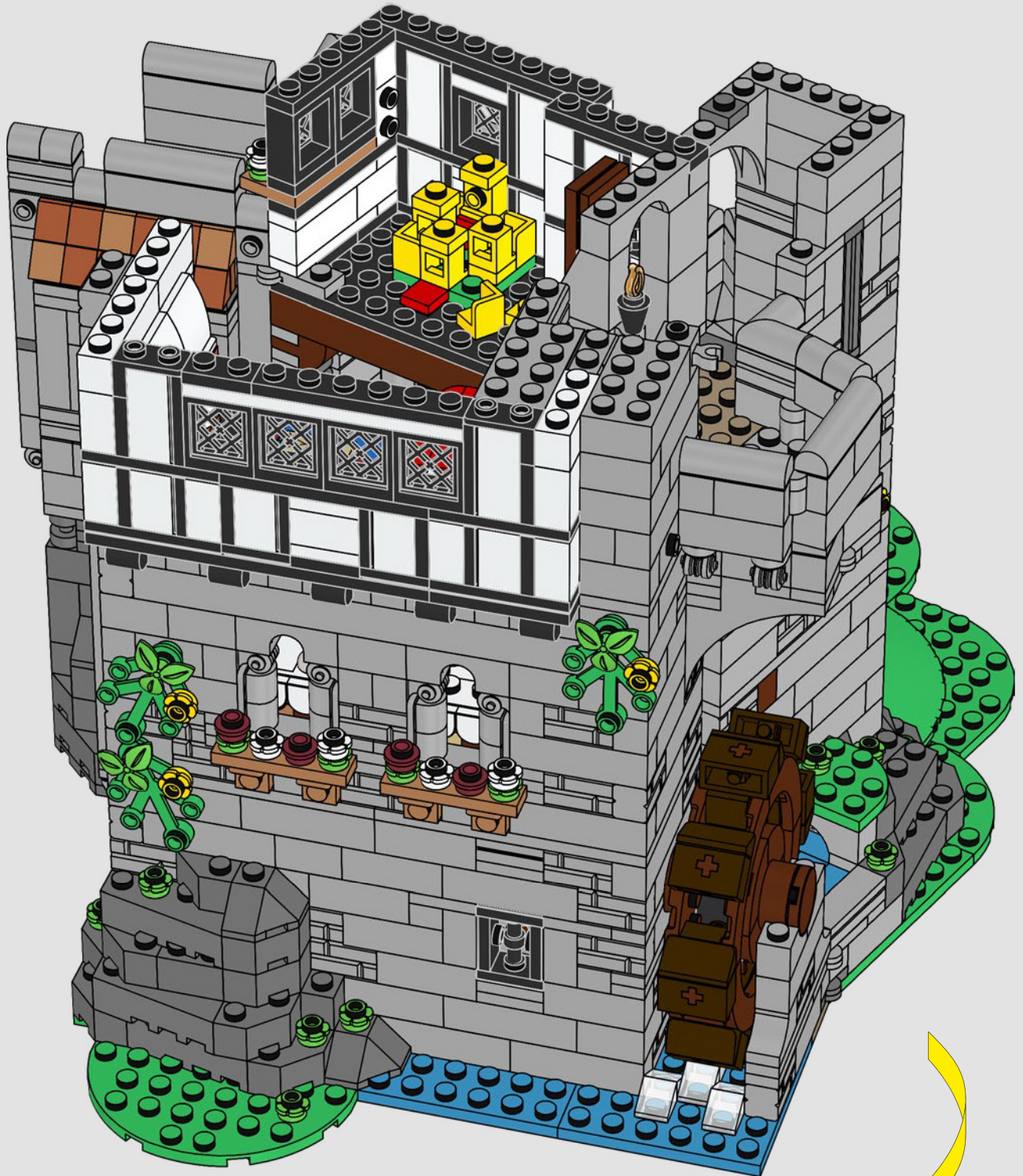

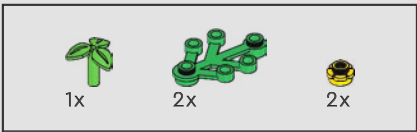

211

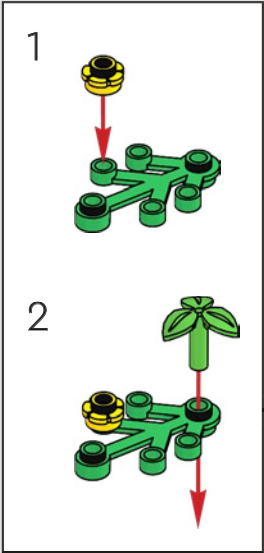
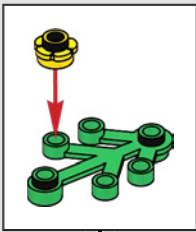

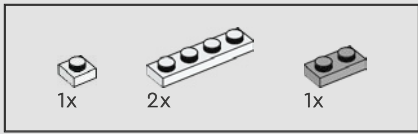

214

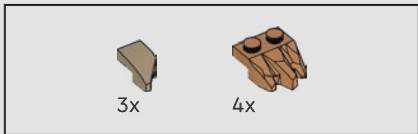
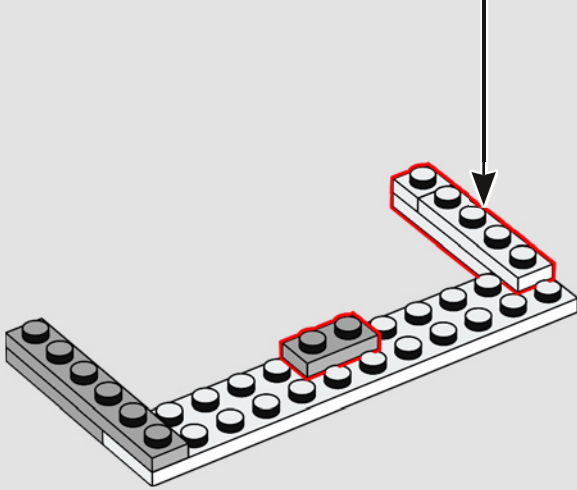
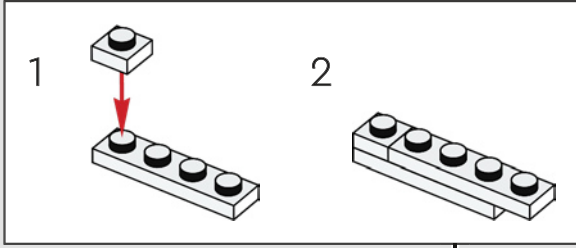

215

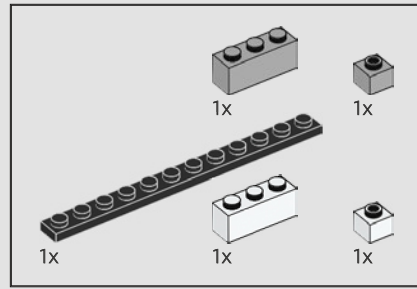
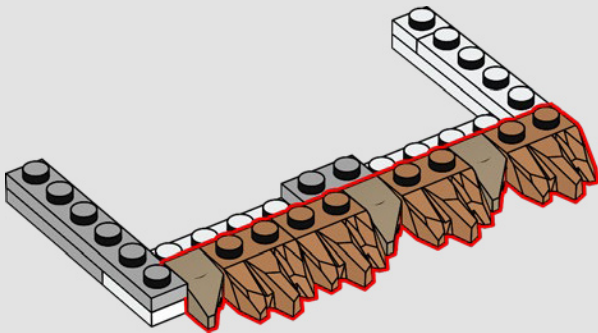

216

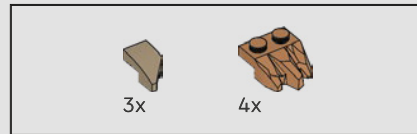
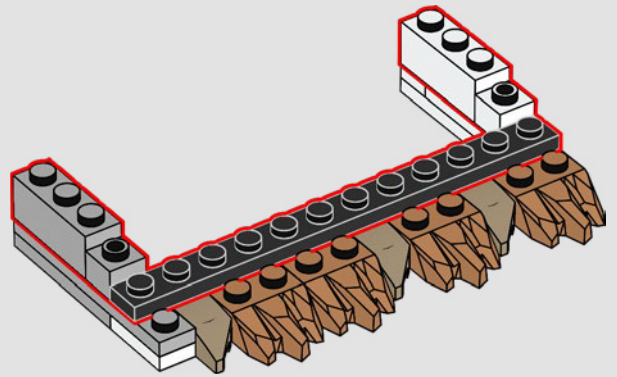

217

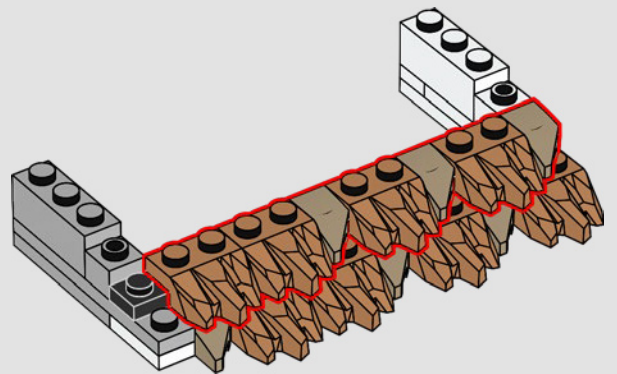

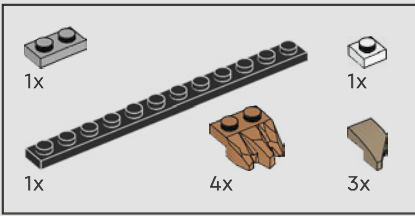

218

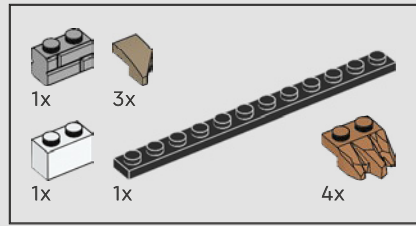
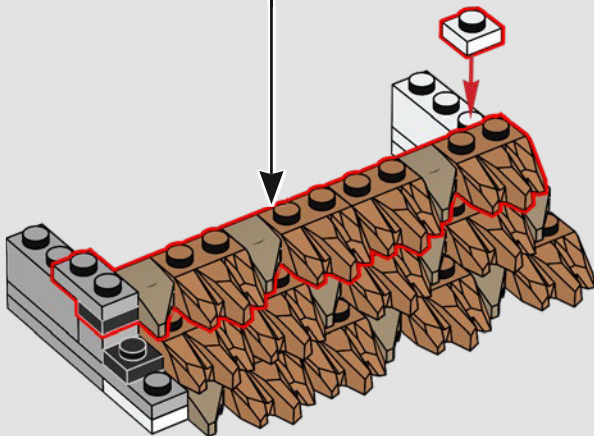
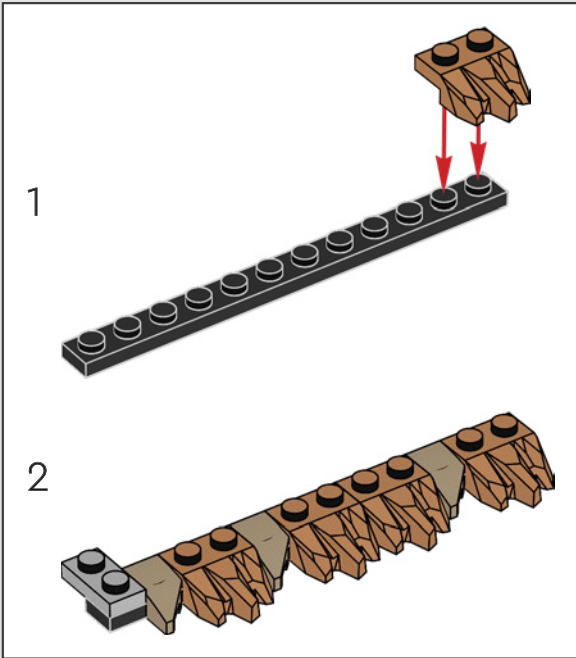

219

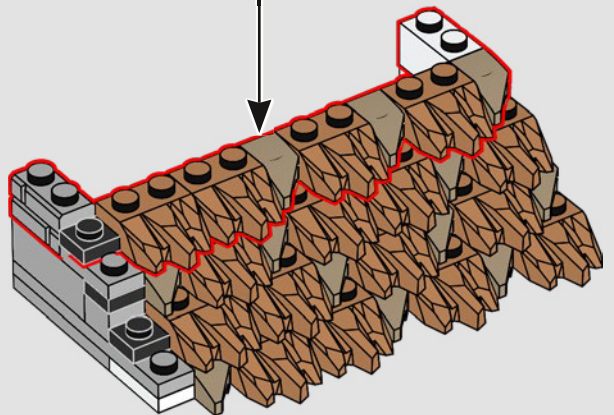
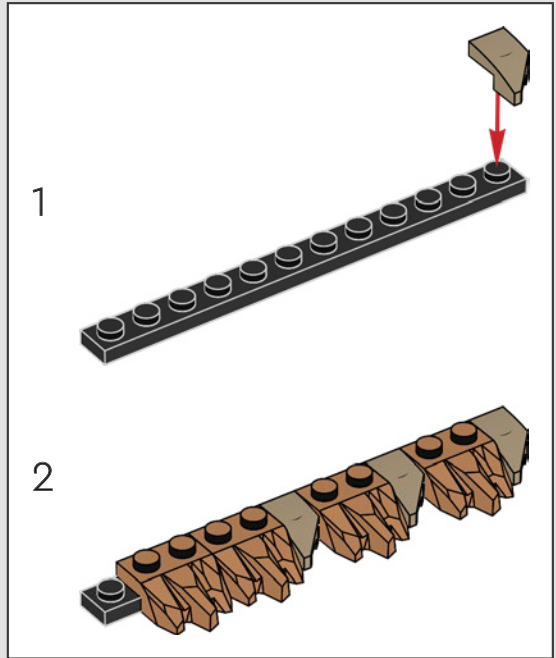

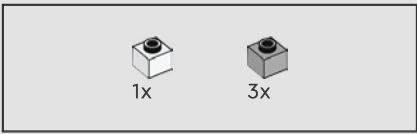

220

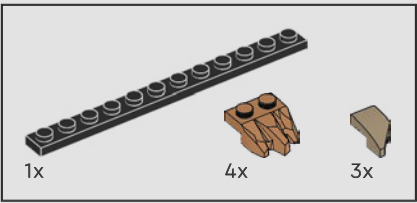
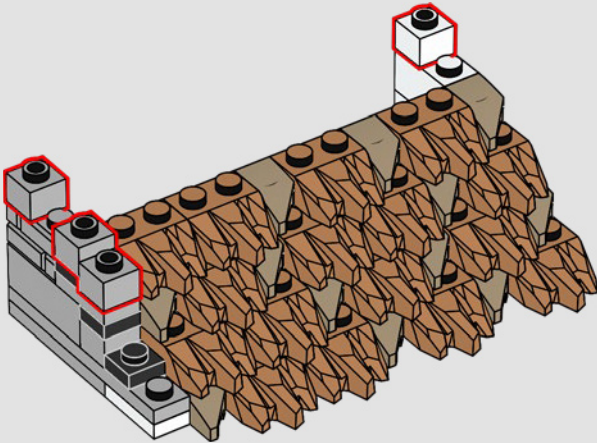

221

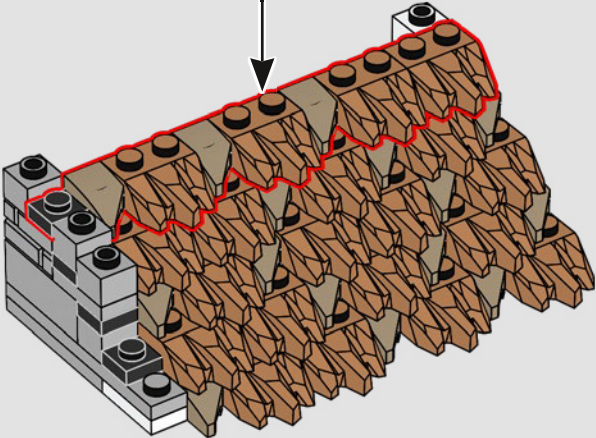
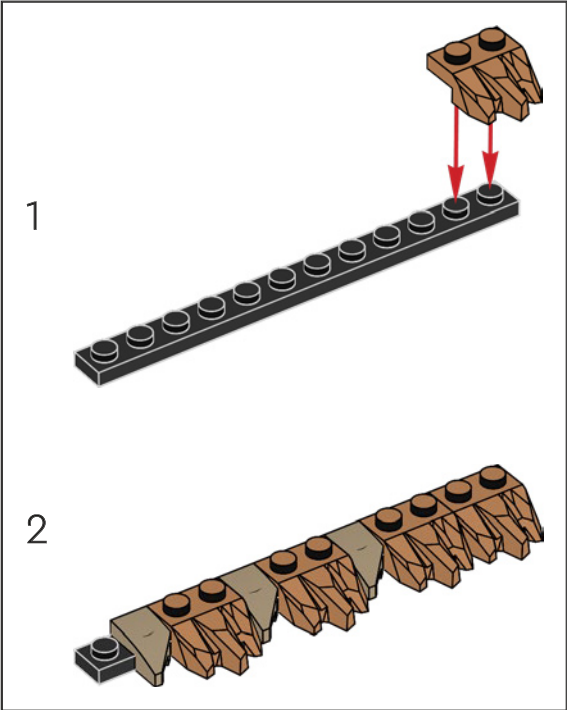

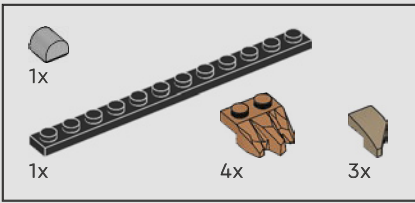

222

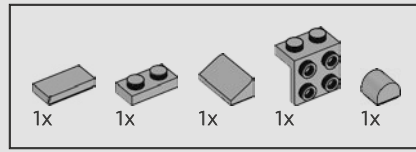
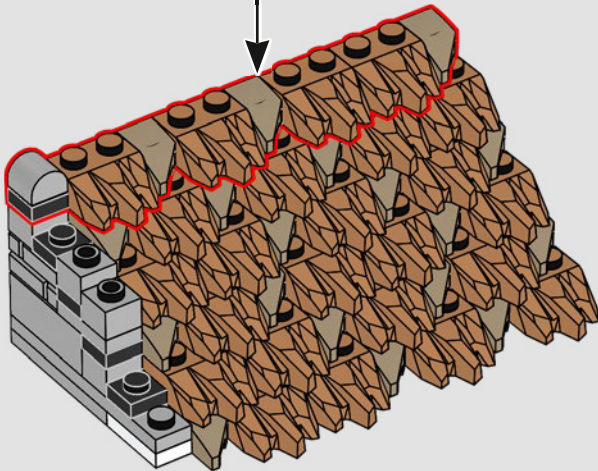
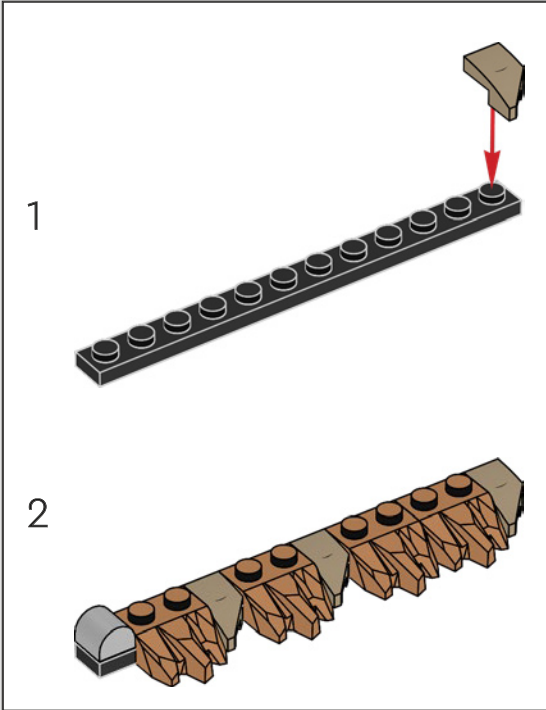

223

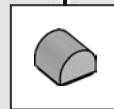
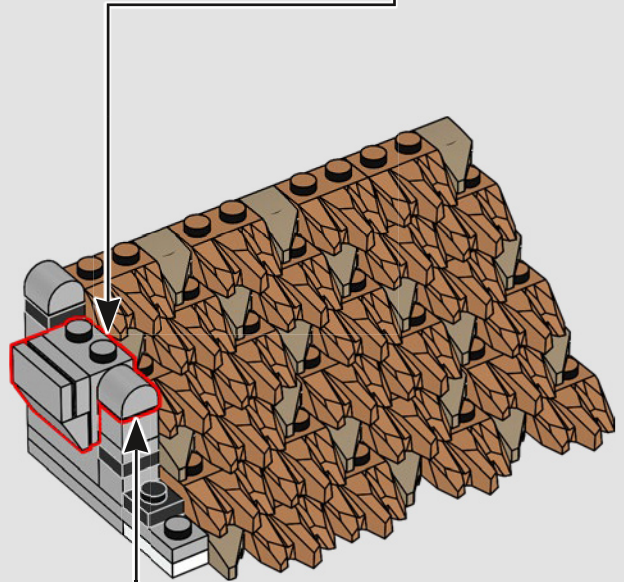
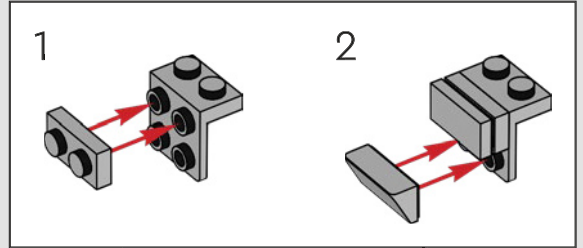



Este techo debería mantener los aposentos cálidos y secos. ¡Qué ingenioso fue usar paja como material de construcción!

224



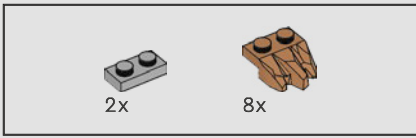

225

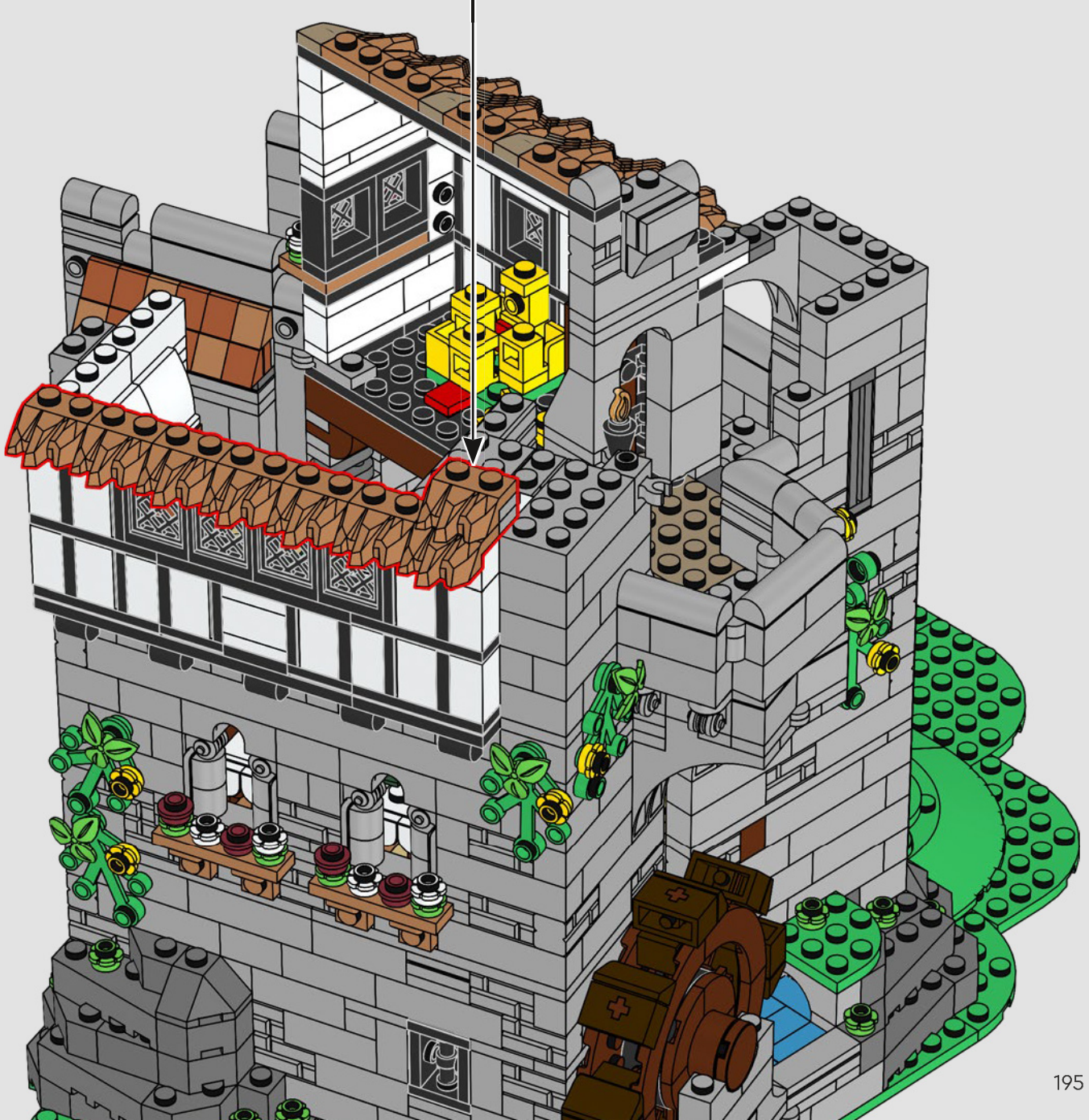
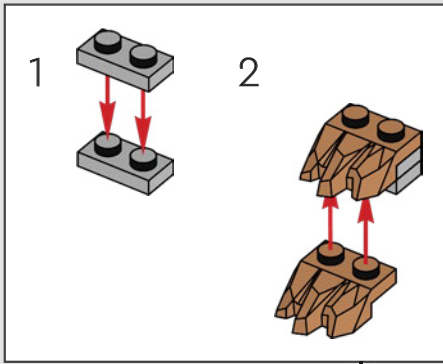

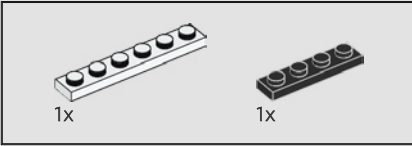
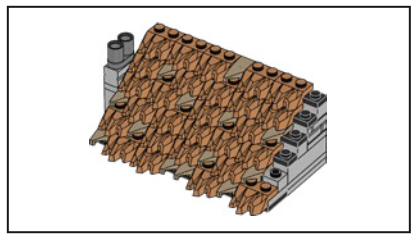

226

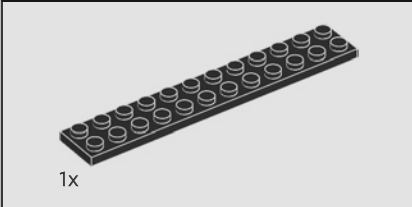
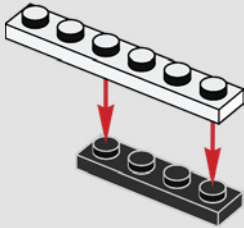

227

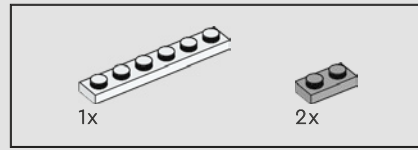
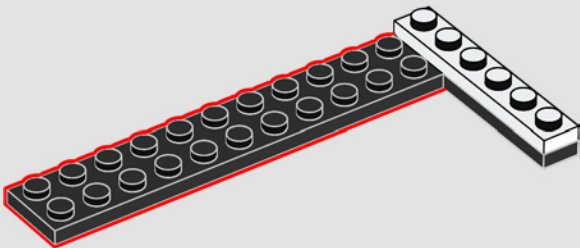

228

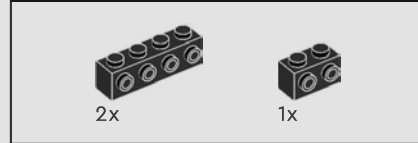
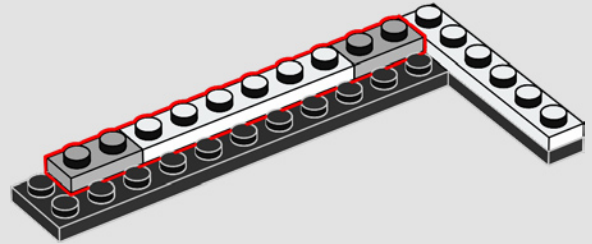

229

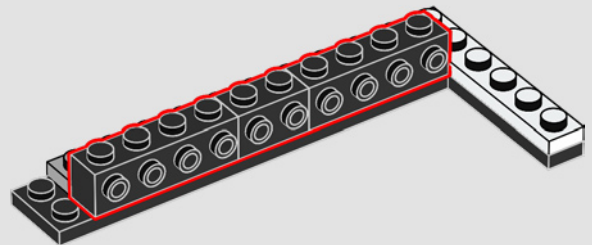

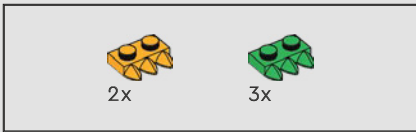

230

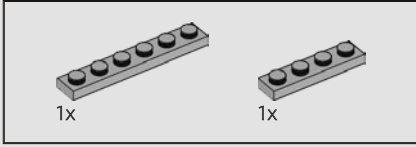
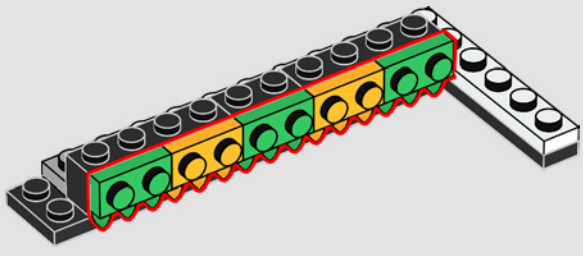

231

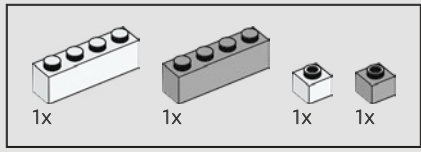
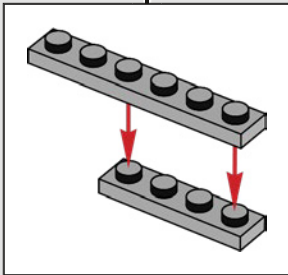
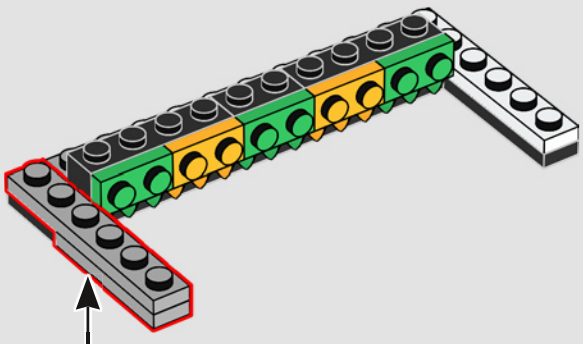

232

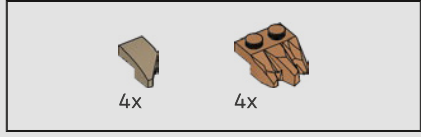
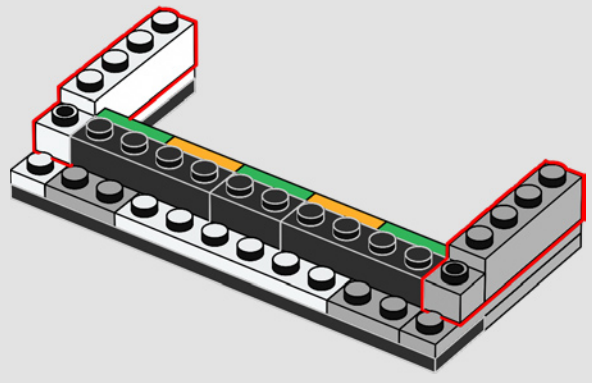

233

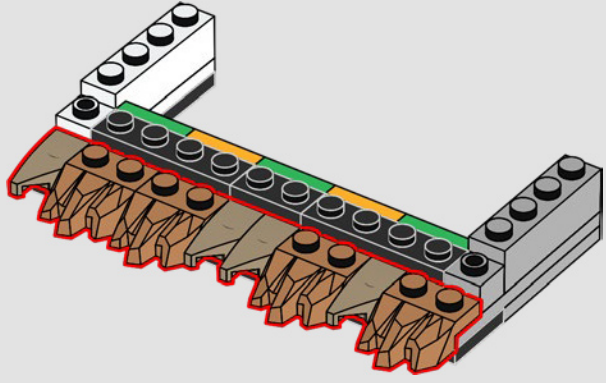

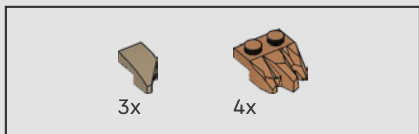

234

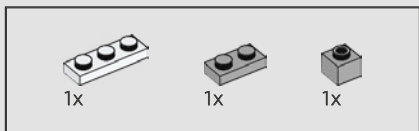
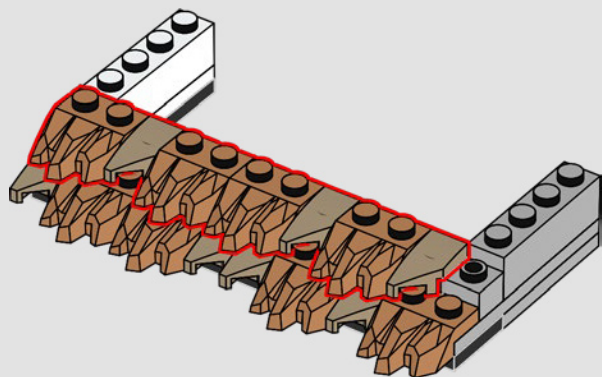

235

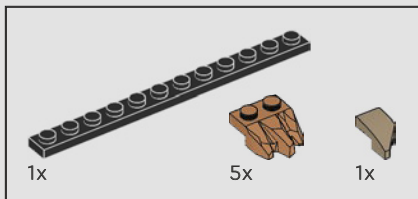
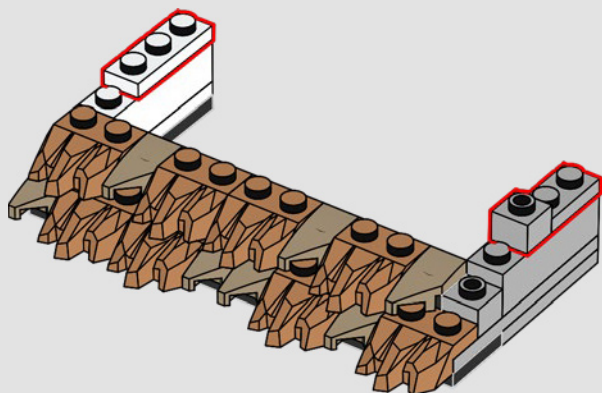

236

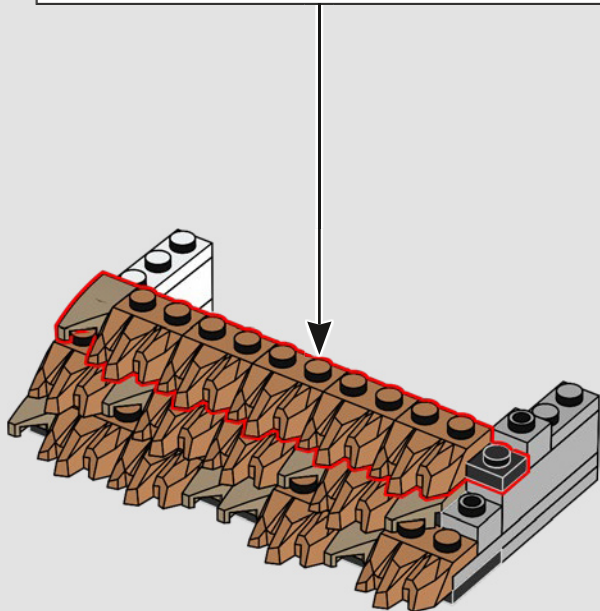
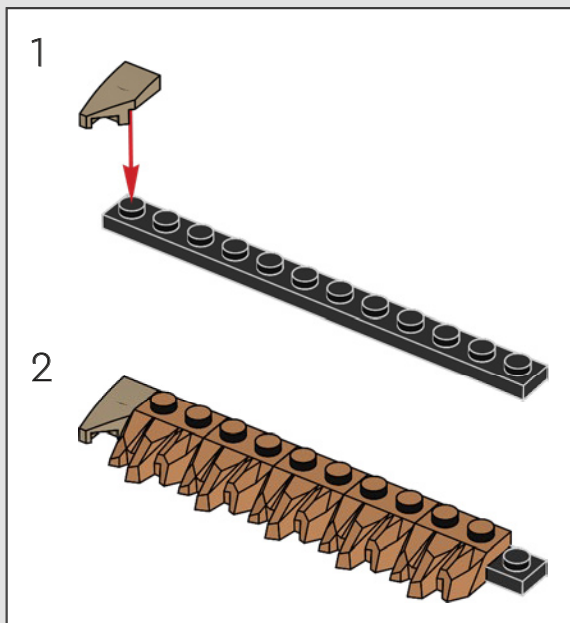

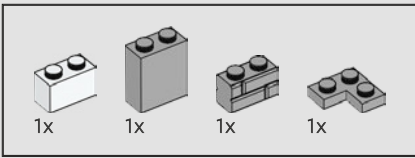

237

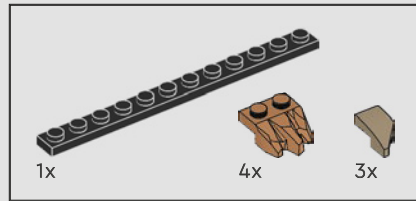
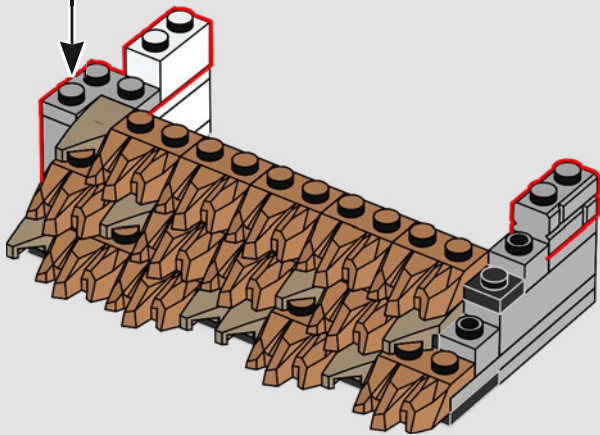
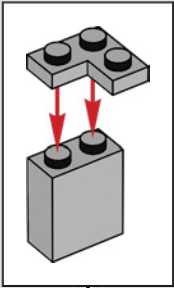

238

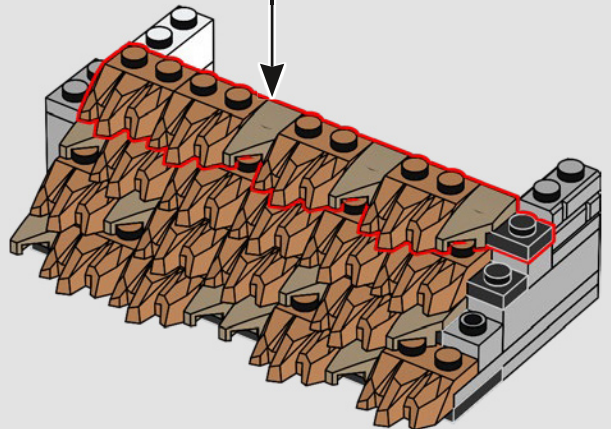
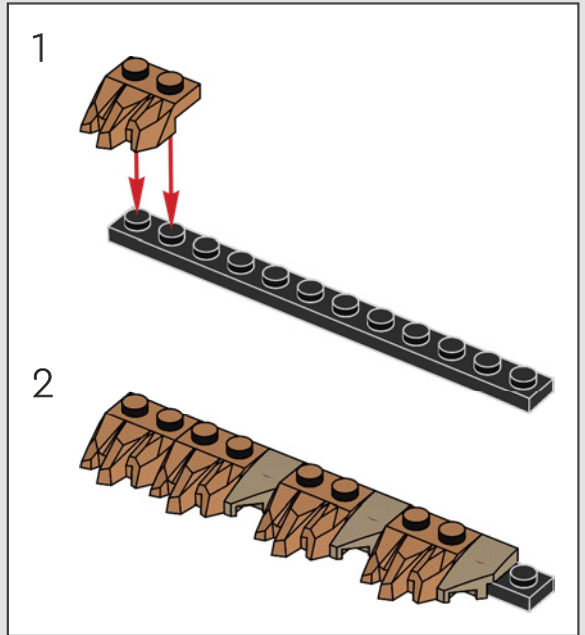

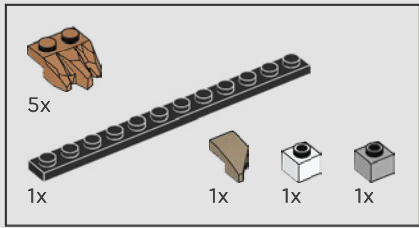

239

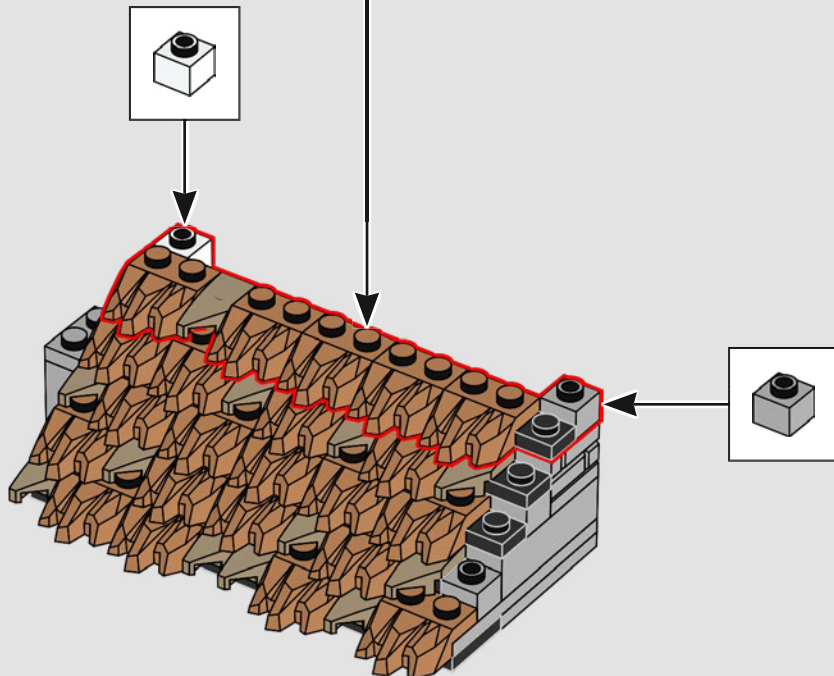
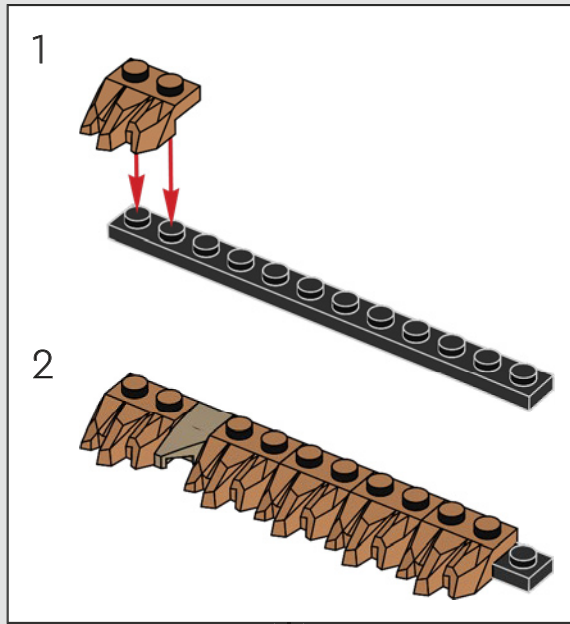

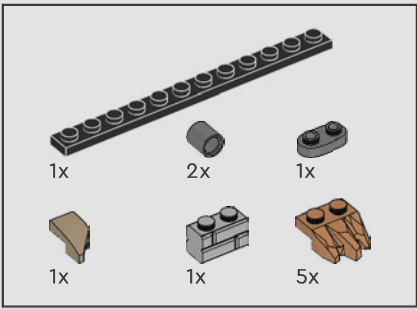

240

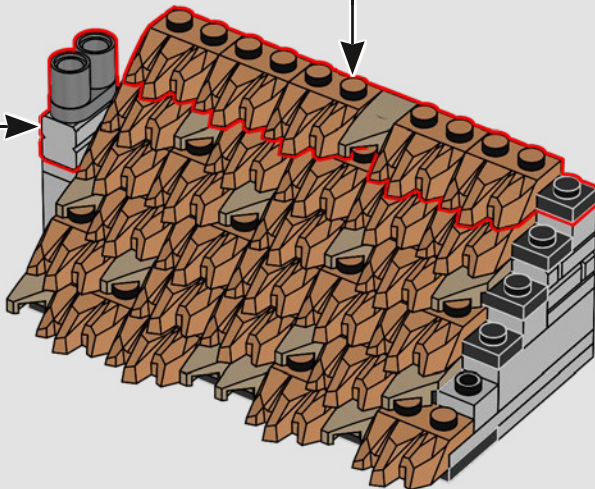
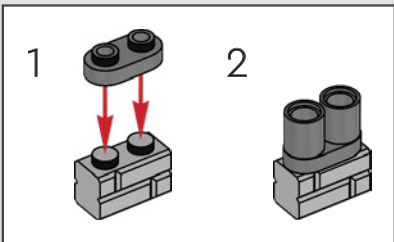
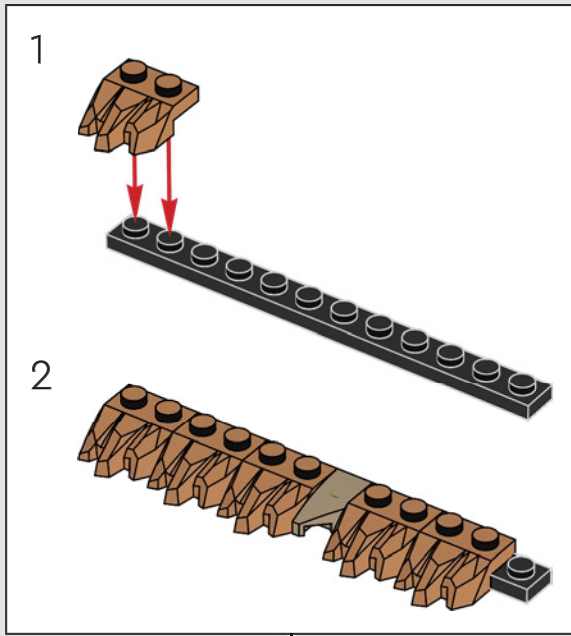

241

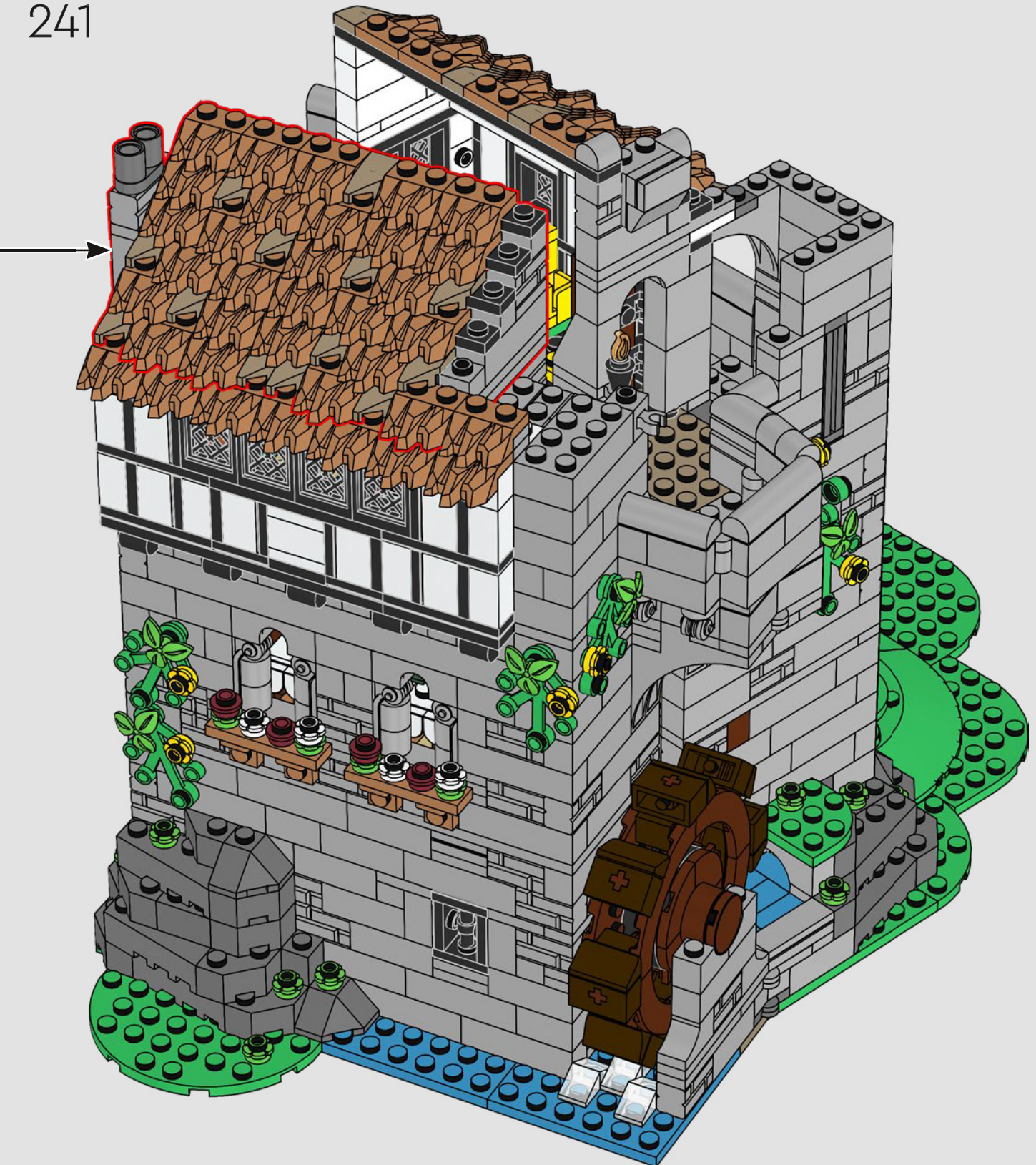

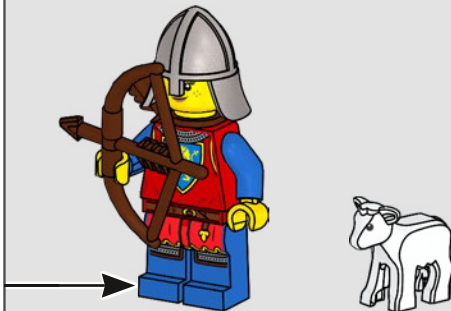
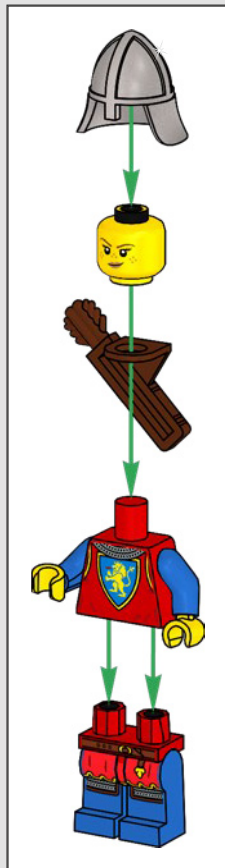

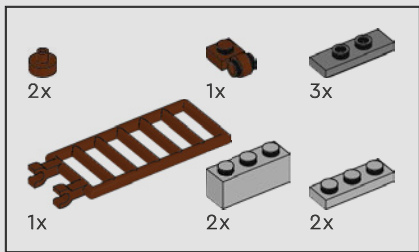

242

1

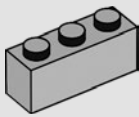

2

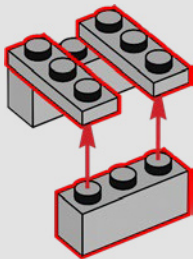

3

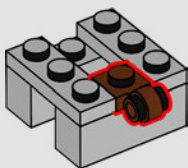

4

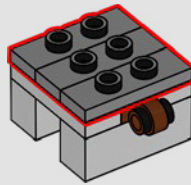

5

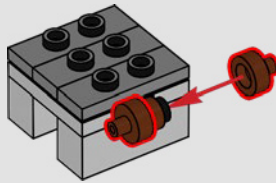

6

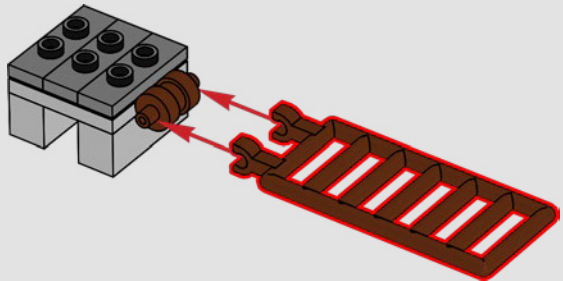

7

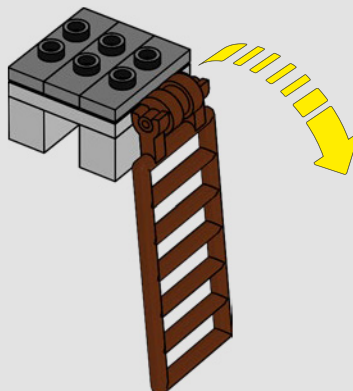



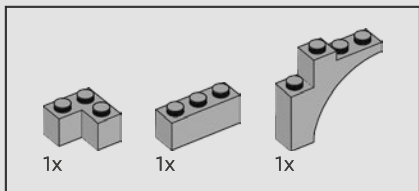

243



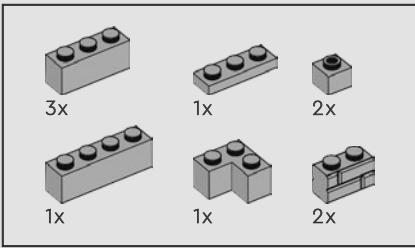

244

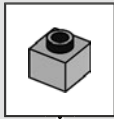
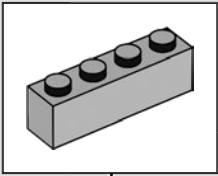

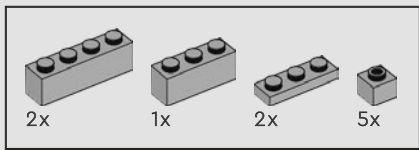

245



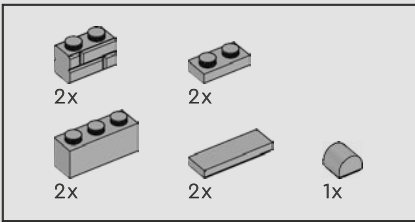

246

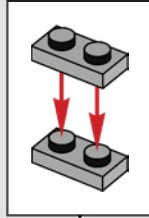

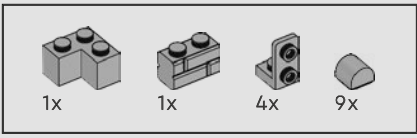

247

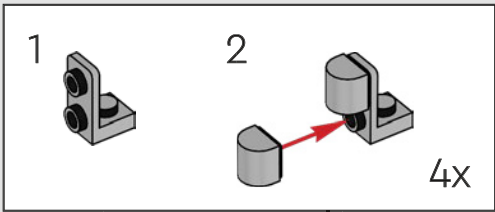

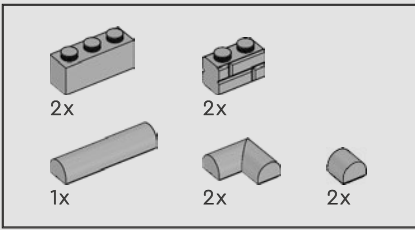

248



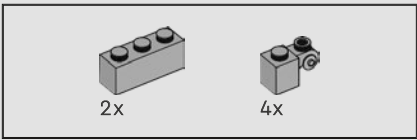

249



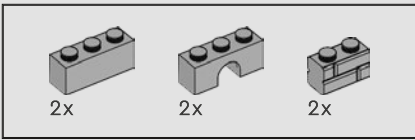

250



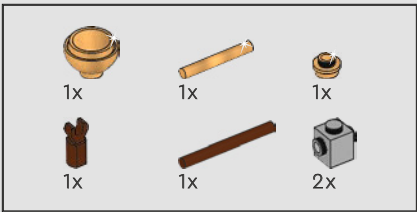

251



Esta campana servirá para advertir a los pobladores si algún día osan regresar los bandoleros Wolfpack.

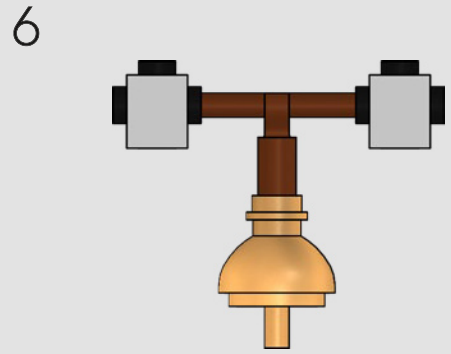
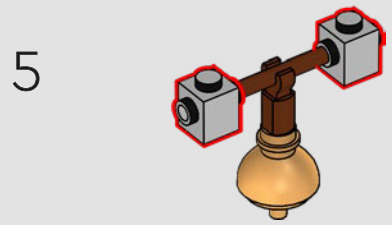
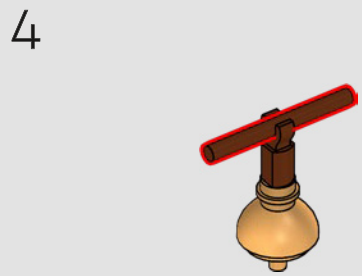
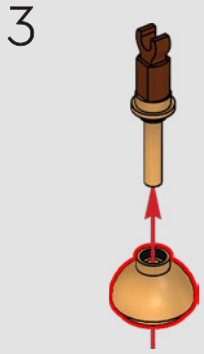
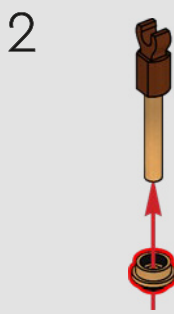
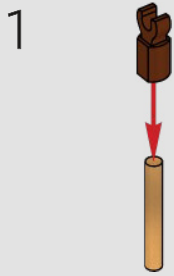

1:1





4x

252





2x



4x

253



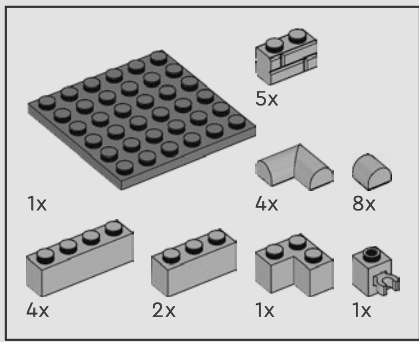

254

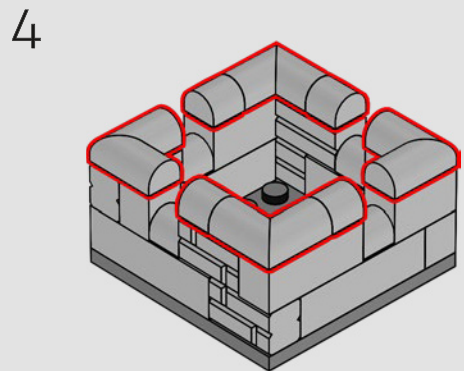
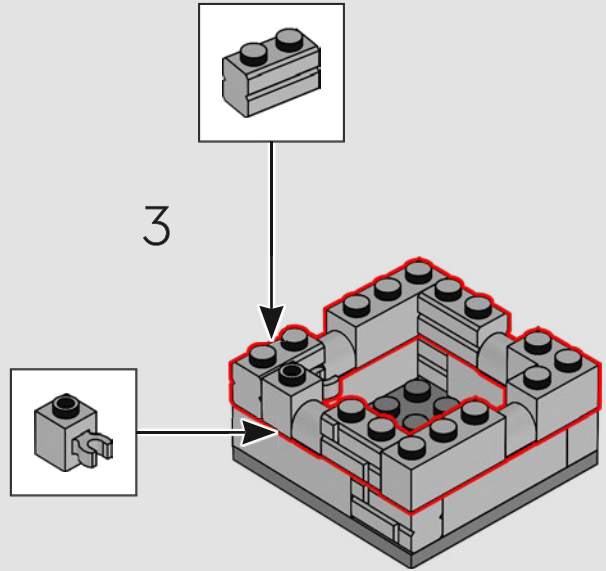
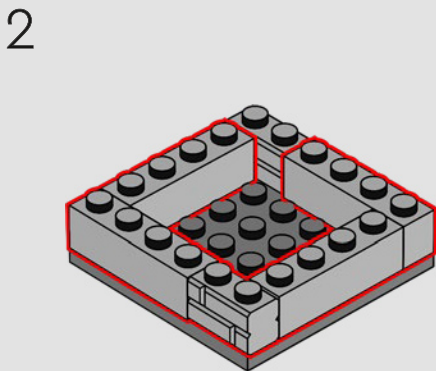
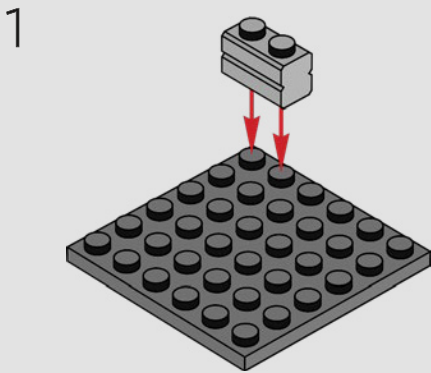



12x

255

12x



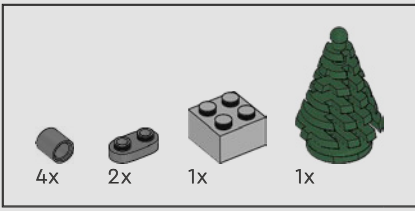

256

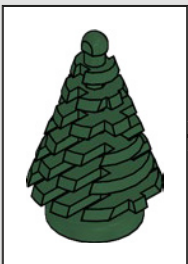
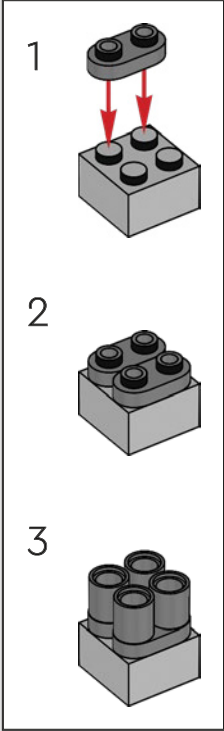

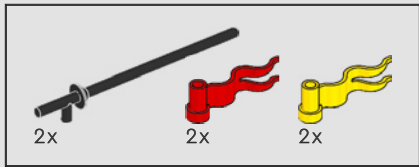

257

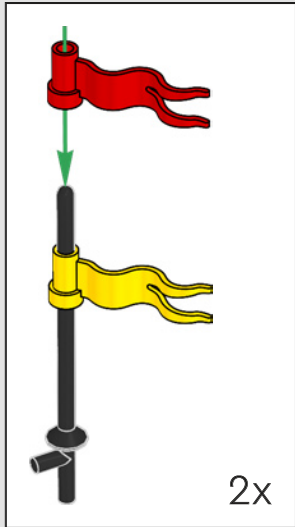

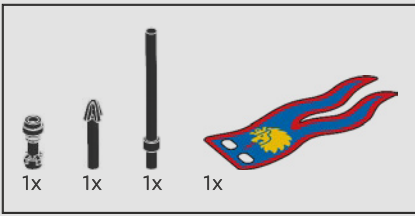

258

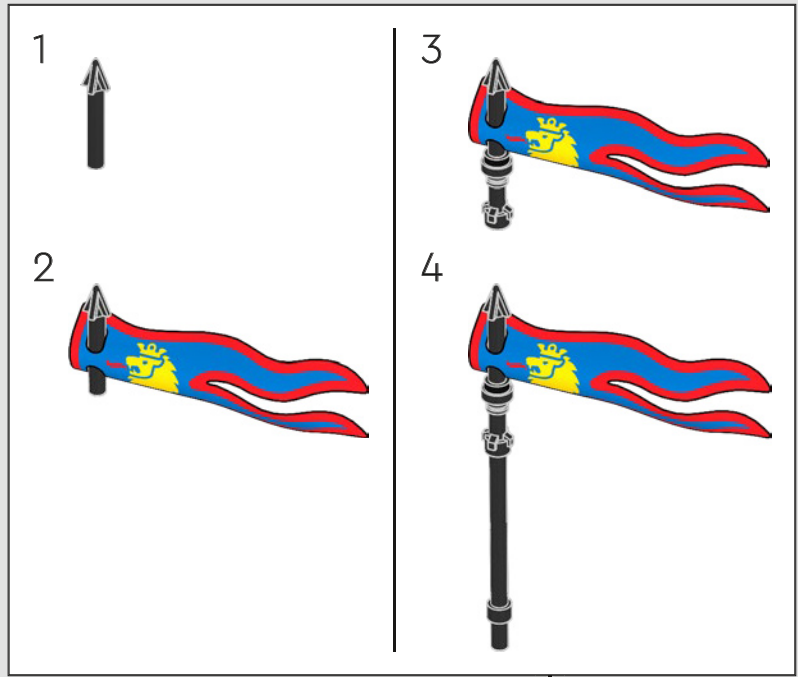



Estos pinos oscuros son refrescantes.
Nunca habían sido de un tono de
verde tan profundo.

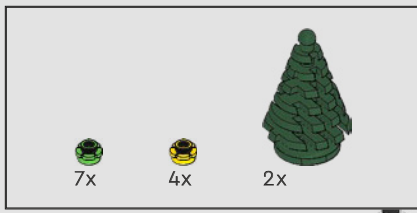

259



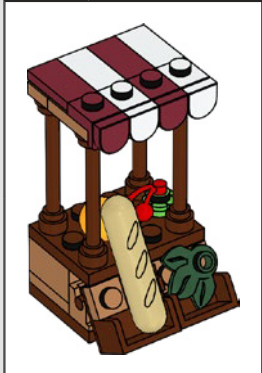

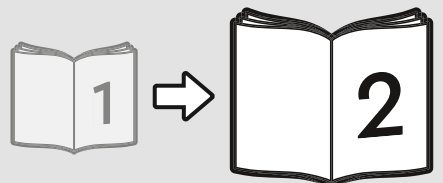



FEEDBACK AND WIN

FEEDBACK AND WIN

Your feedback will help shape the future development of this product series.

Please visit:

FEEDBACK UND GEWINNEN

Dein Feedback trägt zur Weiterentwicklung dieser Produktreihe bei.

Geh auf:

COMMENTEZ ET GAGNEZ

Vos commentaires nous aideront à concevoir les futurs produits de cette gamme.

Rendez-vous sur :

COMENTA Y GANA

Tu opinión nos ayudará a dar forma al desarrollo de esta serie de productos en el futuro.

Visita:

反馈有奖

您的反馈将有助于我们在今后改进本系列产品。

请访问：

[LEGO.com/productfeedback](https://www.lego.com/productfeedback)

By completing, you will automatically enter a drawing to win a LEGO® set.

Terms & Conditions apply.

Durch Ausfüllen nimmst du automatisch an der Verlosung eines LEGO® Preises teil.

Es gelten die Teilnahmebedingungen.

En envoyant vos commentaires, vous serez automatiquement inscrit(e) à un tirage au sort qui vous permettra de remporter un prix LEGO®.

Offre soumise à conditions.

Al contestar, participarás automáticamente en el sorteo y podrás ganar un set LEGO®.

Sujeto a Términos y Condiciones.

完成我们的反馈调查，即可自动进入抽奖环节，赢取乐高®套装。

适用《条款和条件》。

